



GW2406Z
LCD Monitor
User Manual



Copyright

Copyright © 2016 by BenQ Corporation. All rights reserved. No part of this publication may be reproduced, transmitted, transcribed, stored in a retrieval system or translated into any language or computer language, in any form or by any means, electronic, mechanical, magnetic, optical, chemical, manual or otherwise, without the prior written permission of BenQ Corporation.

Disclaimer

BenQ Corporation makes no representations or warranties, either expressed or implied, with respect to the contents hereof and specifically disclaims any warranties, merchantability or fitness for any particular purpose. Further, BenQ Corporation reserves the right to revise this publication and to make changes from time to time in the contents hereof without obligation of BenQ Corporation to notify any person of such revision or changes.

The performance of flicker-free may be affected by external factors such as poor cable quality, unstable power supply, signal interference, or poor grounding, and not limited to the above mentioned external factors. (Applicable for flicker-free models only.)

Servicing

Do not attempt to service this product yourself, as opening or removing covers may expose you to dangerous voltages or other risks. If any of the above mentioned misuse or other accident such as dropping or mishandling occurs, contact qualified service personnel for servicing.

Safety



Please follow these safety instructions for best performance, and long life for your monitor.

- The AC plug isolates this equipment from the AC supply.
- The power supply cord serves as a power disconnect device for pluggable equipment. The socket outlet should be installed near the equipment and be easily accessible.
- This product should be operated from the type of power indicated on the marked label. If you are not sure of the type of power available, consult your dealer or local power company.
- An approved power cord greater or equal to H03VV-F or H05VV-F, 2G or 3G, 0.75mm² must be used.

Care And Cleaning

- **Cleaning.** Always unplug your monitor from the wall outlet before cleaning. Clean the LCD monitor surface with a lint-free, non-abrasive cloth. Avoid using any liquid, aerosol or glass cleaners.
- Slots and openings on the back or top of the cabinet are for ventilation. They must not be blocked or covered. Your monitor should never be placed near or over a radiator or heat source, or in a built-in installation unless proper ventilation is provided.
- Never push objects or spill liquid of any kind into this product.

BenQ ecoFACTS

BenQ has been dedicated to the design and development of greener product as part of its aspiration to realize the ideal of the “Bringing Enjoyment ‘N Quality to Life” corporate vision with the ultimate goal to achieve a low-carbon society. Besides meeting international regulatory requirement and standards pertaining to environmental management, BenQ has spared no efforts in pushing our initiatives further to incorporate life cycle design in the aspects of material selection, manufacturing, packaging, transportation, using and disposal of the products. BenQ ecoFACTS label lists key eco-friendly design highlights of each product, hoping to ensure that consumers make informed green choices at purchase. Check out BenQ’s CSR Website at <http://csr.BenQ.com/> for more details on BenQ’s environmental commitments and achievements.

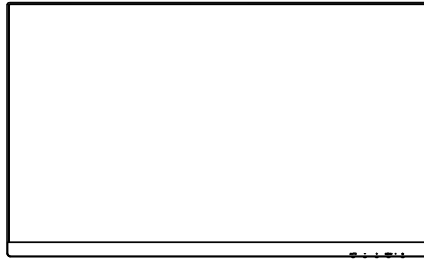

Table of Contents

Copyright.....	2
Disclaimer	2
Servicing.....	2
Safety	2
Care And Cleaning	2
BenQ ecoFACTS	3
Box contents	5
Installation	6
Attach the monitor stand.....	6
Cleaning.....	7
Adjusting viewing angle	7
Connecting the monitor	8
Removing the monitor stand.....	9
Using the monitor wall mounting kit.....	10
Precautions	10
The control panel	11
Source / Auto / Exit	11
Blue Light Reducer / -	11
Volume / +	11
Menu / Enter.....	11
Power.....	11
Basic OSD menu operation	12
Power LED indicator	12
Menu introduction.....	13
Getting the most from your BenQ monitor	15
How to install the monitor on a new computer	16
How to upgrade the monitor on an existing computer.....	17
How to install on Windows 10 system	18
How to install on Windows 8 (8.1) system.....	19
How to install on Windows 7 system	20
Troubleshooting	21
Need more help?.....	22
Specification	23
GW2406Z.....	23
Preset display modes	24
Plug & Play DDC2B feature.....	24

Box contents

When unpacking please check you have the following items. If any are missing or damaged, please contact the place of purchase for a replacement.



LCD Monitor



CD-ROM

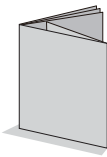

Quick Start Guide

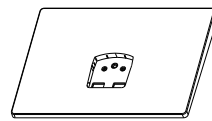

Monitor Base



Stand



Power Cable



D-Sub Cable

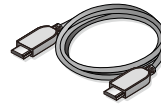

HDMI Cable



Power Adapter



• Available accessories and the pictures shown here may differ from the actual contents and the product supplied for your region. For cables that are not supplied with your product, you can purchase them separately.

• Consider keeping the box and packaging in storage for use in the future when you may need to transport the monitor. The fitted foam packing is ideal for protecting the monitor during transport.

• For GW2406Z, the power adapter is manufactured by TPV ELECTRONICS (FUJIAN) CO., LTD (ADPC1936).



Always keep the product and accessories out of reach of small children.

Installation



- If the computer is turned on you must turn it off before continuing. Do not plug-in or turn-on the power to the monitor until instructed to do so.
 - The following illustrations are for your reference only. Available input and output jacks may vary depending on the purchased model.
 - Please be careful to prevent damage to the monitor. Placing the screen surface on an object like a stapler or a mouse will crack the glass or damage the LCD substrate voiding your warranty. Sliding or scraping the monitor around on your desk will scratch or damage the monitor surround and controls.
-

Attach the monitor stand

1. Protect the monitor and screen by clearing a flat open area on your desk and placing a soft item like the monitor packaging bag on the desk for padding.
2. Gently lay the screen face down on a flat clean padded surface.
3. Orient and align the stand base socket with the end of the stand arm, then push them together until they click and lock into place.
4. Tighten the screw on the bottom of the monitor base as illustrated.
5. Carefully lift the monitor, turn it over and place it upright on its stand on a flat even surface.

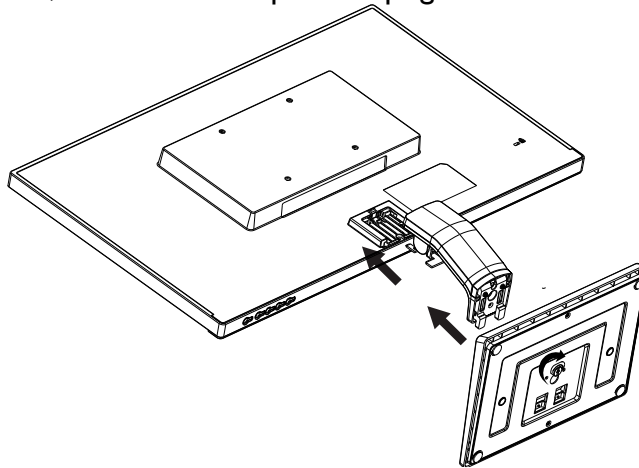

You should position the monitor and angle the screen to minimize unwanted reflections from other light sources.

Cleaning



Please disconnect the power cord before cleaning the product.

Clean the cabinet regularly with a cloth. You can use soft-detergent to wipe out the stain, instead of strong-detergent which will cauterize the product cabinet.

When cleaning, make sure no detergent is leaked into the product. The cleaning cloth should not be too rough as it will scratch the screen surface.



Adjusting viewing angle

For optimal viewing it is recommended to look at the full face of the monitor, then adjust the monitor's angle to your own preference.

Hold the stand so you will not topple the monitor when you change the monitor's angle.

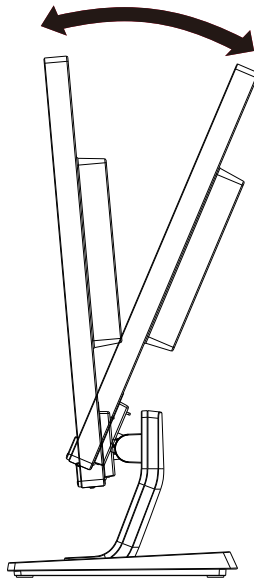

Do not touch the LCD screen when you change the angle. It may cause damage or break the LCD screen.

Connecting the monitor

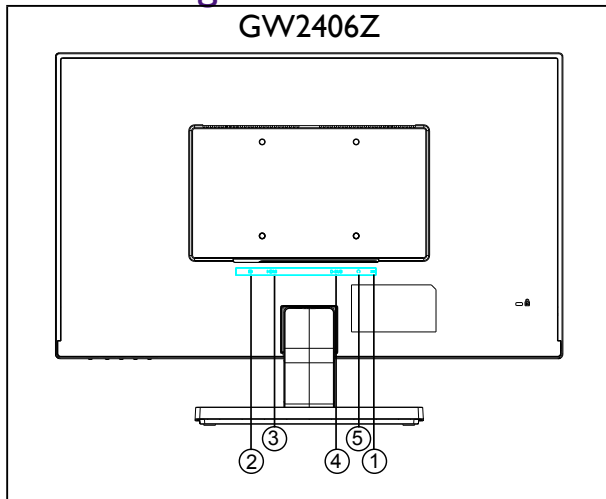

No.	Description
1	AC power input jack
2	DP socket
3	HDMI socket
4	D-Sub socket
5	Audio Line Out

1. To protect equipment, always turn off the PC and LCD monitor before connecting.
2. Connect the power cord to the power adapter. Plug one end of the power cord into the socket labelled  on the rear of the monitor. Plug the other end of the power cord into a power outlet and turn it on.
3. Connect the plug of the DP cable to the monitor DP socket. Connect the other end of the cable to the DP port of the computer.
4. Connect the plug of the HDMI cable to the HDMI port on the monitor. Connect the other end of the cable to the HDMI port of a digital output device
5. Connect the plug of the D-Sub cable (at the end without the ferrite filter) to the monitor video socket. Connect the other end of the cable (at the end with the ferrite filter) to the computer video socket.
6. You can inset the headset into headphone jack beside the input pin on the back of display.
7. Turn on your monitor and computer. If your monitor displays an image, installation is complete. If it does not display an image, please refer to [“Troubleshooting” on 21](#).

Removing the monitor stand

1. Turn off the monitor and the power before unplugging the power cable. Turn off the computer before unplugging the monitor signal cable.
2. Protect the monitor and screen by clearing a flat open area on your desk and placing a soft item like a towel on the desk for padding, before laying the screen face down on a flat clean padded surface.
3. Release the screw on the bottom of the monitor base and detach the monitor base as illustrated.

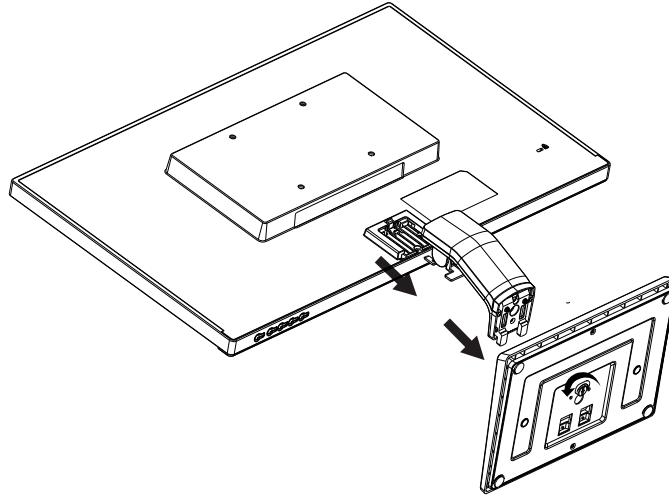

Please be careful to prevent damage to the monitor. Placing the screen surface on an object like a stapler or a mouse will crack the glass or damage the LCD substrate voiding your warranty. Sliding or scraping the monitor around on your desk will scratch or damage the monitor surround and controls.

Using the monitor wall mounting kit

The back of your LCD monitor has a VESA standard mount with 100mm pattern, allowing the installation of a wall mount bracket. Before starting to install a monitor wall mounting kit, please read the precautions carefully.

Precautions

- Install your monitor and monitor mounting kit on a wall with flat surface.
- Ensure that the wall material and the standard wall mount bracket (purchased separately) are stable enough to support the weight of the monitor. Refer to the product specifications for weight information.
- Turn off the monitor and the power before disconnecting the cables from the LCD monitor.

1. Remove the monitor stand.

Lay the screen face down on a clean and well-padded surface.

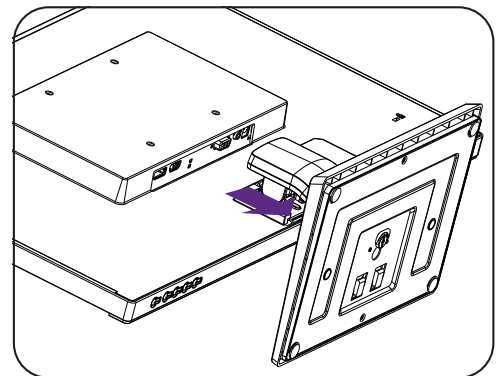
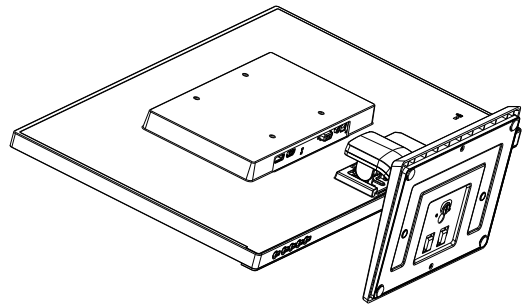

In case you intend to use your monitor on the stand in the future, please keep the monitor base, monitor stand, and screws somewhere safe for future use.

2. Follow the instruction manuals of the wall mount bracket you purchased to complete the installation.



Use four M4 x 10 mm screws to fix a VESA standard wall mount bracket to the monitor. Make sure that all screws are tightened and secured properly. Consult a professional technician or BenQ service for wall mount installation and safety precautions.

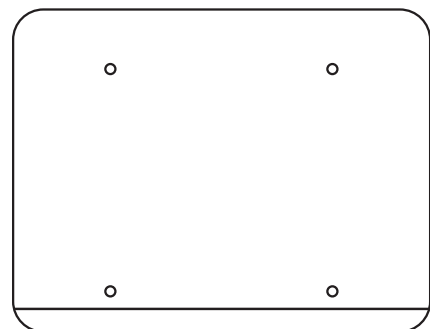

The control panel

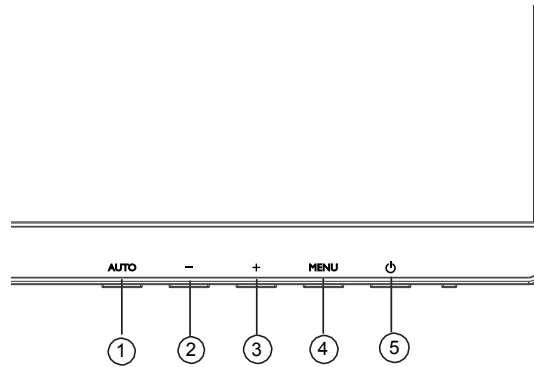

GW2406Z	
No.	Description
1	Source / Auto / Exit
2	Blue Light Reducer / -
3	Volume / +
4	Menu / Enter
5	Power

Source / Auto / Exit

- Press and hold the **AUTO** key for 3 seconds to adjust vertical position, phase, horizontal position and pixel clock automatically.
- Press the **AUTO** key to switch to a desired input source, and confirm with the **MENU** key.
- When in the OSD menu, press to exit.

Blue Light Reducer / -

- Press to select Blue Light Reducer.
- When in the OSD menu, press for Down/Decrease adjustment .

Volume / +

- By default, the key is the hot key for Volume.
- When in the OSD menu, press for Up/Increase adjustment .



Menu / Enter

- Press to display the OSD menu.
- When in the OSD menu, press to confirm the selection.

Power

Press the  button to turn on / off the monitor.

Basic OSD menu operation

- Press the **MENU** button to activate the OSD menu.
- Press - or + to navigate through the menu options. Once the desired option is highlighted, press the **MENU** key to confirm the selection.
Press - or + to change the settings of the selected function.
Press **MENU** key to save the new setting and exit the current function. Press - or + to select another function in sub-menu.
Press **AUTO** to exit. If you want to adjust any other function, repeat the previous steps.
- OSD Lock: To lock the OSD, press and hold the **MENU** key while the monitor is off and then press the  key to turn the monitor on. To unlock the OSD, press and hold the **MENU** button while the monitor is off and then press the  key to turn the monitor on.



• If the product screen size is 4:3 or input signal resolution is wide, the **Image Ratio** is disabled.

Power LED indicator

LED indicator	System status
Blue	The monitor is powered on.
Orange	The monitor is in Standby mode.

Menu introduction

Available menu options may vary depending on the input sources, functions and settings. Menu options that are not available will become grayed out. And keys that are not available will be disabled and the corresponding OSD icons will disappear. For models without certain functions, their settings and related items will not appear on the menu.

Main menu	Function		Range
Luminance	Contrast	Adjusts the degree of difference between darkness and lightness.	0-100
	Brightness	Adjusts the balance between light and dark shades.	0-100
	Eco mode	Select a picture mode that best suits the type of images shown on the screen.	<ul style="list-style-type: none"> • Standard • Text • Internet • Game • Movie • Sports
	DCR	Sets dynamic contrast ratio.	<ul style="list-style-type: none"> • On • Off
Image Setup	Clock	Adjusts the pixel clock frequency timing to synchronize with the analog input video signal.	0-100
	Phase	Adjusts the pixel clock phase timing to synchronize with the analog input video signal.	0-100
	H. Position	Adjusts the horizontal position of the screen image.	0-100
	V. Position	Adjusts the vertical position of the screen image.	0-100
	Image Ratio	This feature is provided to allow aspect ratios other than 16:9 to be displayed without geometric distortion.	<ul style="list-style-type: none"> • Wide • 4:3
Color Temp.	Warm	Applies a warm tint to the image and is factory pre-set to the news print standard white color.	
	Normal	Allows video and still photographs to be viewed with natural coloring.	
	Cool	Applies a cool tint to the image and is factory pre-set to the PC industry standard white color.	
	User	The blend of the Red, Green and Blue primary colors can be altered to change the color tint of the image. Go to the succeeding R (red), G (green), and B (blue) menus to change the settings. Decreasing one or more of the colors will reduce their respective influence on the color tint of the image. (e.g. if you reduce the Blue level the image will gradually take on a yellowish tint. If you reduce Green, the image will become a magenta tint.)	<ul style="list-style-type: none"> • Red • Green • Blue
	sRGB	Recall sRGB Color Temperature from EEPROM.	

Main menu	Function		Range
OSD Setup	H. Position	Adjusts the horizontal position of the OSD menu.	0-100
	V. Position	Adjusts the vertical position of the OSD menu.	0-100
	Timeout	Adjusts the display time of the OSD menu.	5-100
	Language	Sets the OSD menu language.	<ul style="list-style-type: none"> • English • Español • Français • Português • Deutsch • Nederlands • Svenska • Italiano • Polski • Česky • Русский • 简体中文 • 日本語 • 繁體中文 • 한국어
Extra	Input Select	Use this to change the input to that appropriate to your video cable connection type.	<ul style="list-style-type: none"> • D-Sub • HDMI • DP
	DDC/CI	Allows the monitor settings to be set through the software on the PC.	<ul style="list-style-type: none"> • On • Off
	Reset	Resets all mode, color and geometry settings to the factory default values.	
	Information	Displays the current monitor property settings.	<ul style="list-style-type: none"> • Resolution • H. Frequency • V. Frequency
Low Blue Light	Decreases the blue light emitted from the display to reduce the risk of blue light exposure to your eyes.		
	 The value for each Low Blue Light mode indicates how much blue light is decreased compared with the Standard mode.		
	Mode 1	For viewing multimedia files.	-30%
	Mode 2	For web surfing.	-50%
Mode 3	For office works or office environment.	-60%	

Getting the most from your BenQ monitor

To gain the most benefit from your new BenQ LCD monitor, you should install the custom BenQ LCD Monitor driver software as provided on the BenQ LCD Monitor CD-ROM.

The circumstances under which you connect and install your BenQ LCD Monitor will determine which process you need to follow to successfully install the BenQ LCD Monitor driver software. These circumstances relate to which version of Microsoft Windows you are using, and whether you are connecting the monitor and installing the software onto a new computer (without existing monitor driver software), or whether you are upgrading an existing installation (which already has existing monitor driver software) with a newer monitor.

In either case however, the very next time you turn on your computer (after connecting the monitor to your computer), Windows will automatically recognize the new (or different) hardware, and will launch its **Found New Hardware wizard**.

Follow the wizard instructions until it asks you to select a monitor model. At that point, click the **Have Disk** button, insert the BenQ LCD Monitor CD-ROM and select the appropriate monitor model. Further details and step-by-step instructions for either an automatic (new) or upgrade (existing) installation, see:

- ["How to install the monitor on a new computer" on I6.](#)
- ["How to upgrade the monitor on an existing computer" on I7.](#)



- If you require a User Name and Password to login to your Windows computer, you must be logged on as an Administrator or as a member of the Administrators group in order to install the monitor driver software. Furthermore, if your computer is connected to a network which has security access requirements, network policy settings may prevent you from installing software on your computer.
 - To check the name of the purchased model, refer to the specification label on the back of the monitor.
-

How to install the monitor on a new computer

This instruction details the procedure for selecting and installing the BenQ LCD Monitor driver software on a new computer which has never had a monitor driver installed before. This instruction is only suitable for a computer which has never been used before, and for which the BenQ LCD Monitor is the first ever monitor to be connected to it.



If you are adding the BenQ LCD Monitor to an existing computer that has already had another monitor connected to it (and has monitor driver software installed), you should not be following these instructions. You should instead be following the instructions for "[How to upgrade the monitor on an existing computer](#)" on 17.

1. Follow the instructions in "[Installation](#)" on 6.
When Windows starts, it will automatically detect the new monitor and launch the **Found New Hardware Wizard**. Follow the prompts until it displays the option to **Install Hardware Device Drivers**.
2. Insert the BenQ LCD Monitor CD-ROM into a CD drive on the computer.
3. Check **Search for a suitable driver for my device** option, and click **Next**.
4. Check the option for CD-ROM drives (uncheck all others) and click **Next**.
5. Look to confirm that the wizard has selected the correct name of your monitor and click **Next**.
6. Click **Finish**.
7. Restart the computer.



To find the suitable driver files for the purchased model, refer to the following table.

Driver files	Suitable models
GW2406Z	GW2406Z

How to upgrade the monitor on an existing computer

This instruction details the procedure for manually updating the existing monitor driver software on your Microsoft Windows computer. It is currently tested as compatible for Windows 10, Windows 8.1, Windows 8, and Windows 7 Operating System (OS).



The BenQ LCD Monitor driver for your model may well function perfectly with other versions of Windows, however, as at the time of writing, BenQ has done no testing of this driver on other versions of Windows and cannot guarantee its operation on those systems.

Installing monitor driver software involves selecting an appropriate information file (.inf) on the BenQ LCD Monitor CD-ROM for the particular model monitor you have connected, and letting Windows install the corresponding driver files from the CD. You need only steer it in the right direction. Windows has an Upgrade Device Driver Wizard to automate the task and guide you through the file selection and installation process.

See:

- ["How to install on Windows 8 \(8.1\) system" on 1918.](#)
- ["How to install on Windows 8 \(8.1\) system" on 19.](#)
- ["How to install on Windows 7 system" on 20.](#)

How to install on Windows 10 system

1. Open **Display Properties**.
Go to Start, Settings, Devices, Devices and Printers and right-click the name of your monitor from the menu.
2. Select **Properties** from the menu.
3. Click the **Hardware** tab.
4. Click **Generic PnP Monitor**, and then the **Properties** button.
5. Click the **Driver** tab and the **Update Driver** button.
6. Insert the BenQ LCD Monitor CD-ROM into a CD drive on the computer.
7. In the **Update Driver Software** window, select the option **Browse my computer for driver software**.
8. Click **Browse** and navigate to the following directory: d:\BenQ_LCD\Driver\ (where d is the drive letter designator for the CD-ROM drive).



The drive letter for your CD drive may differ from the example above depending upon your system - it may be 'D:' or 'E:' or 'F:' etc.

9. Select the correct folder name of your monitor from provided driver list, and click **Next**.
This will copy and install the appropriate monitor driver files to your computer.
10. Click **Close**.
You may be prompted to restart your computer after the driver update is complete.

How to install on Windows 8 (8.1) system

1. Open **Display Properties**.
Move the cursor to the lower-right of the screen or press the **Windows + C** buttons on the keyboard to bring up the **Charm** bar. Go to **Settings, Control Panel, Devices and Printers** and right-click the name of your monitor from the menu.
Alternatively, right-click the desktop and select **Personalize, Display, Devices and Printers**, and right-click the name of your monitor from the menu.
2. Select **Properties** from the menu.
3. Click the **Hardware** tab.
4. Click **Generic PnP Monitor**, and then the **Properties** button.
5. Click the **Driver** tab and the **Update Driver** button.
6. Insert the BenQ LCD Monitor CD-ROM into a CD drive on the computer.
7. In the **Update Driver Software** window, select the option **Browse my computer for driver software**.
8. Click **Browse** and navigate to the following directory: d:\BenQ_LCD\Driver\ (where d is the drive letter designator for the CD-ROM drive).



The drive letter for your CD drive may differ from the example above depending upon your system - it may be 'D:' or 'E:' or 'F:' etc.

9. Select the correct folder name of your monitor from provided driver list, and click **Next**.
This will copy and install the appropriate monitor driver files to your computer.
10. Click **Close**.
You may be prompted to restart your computer after the driver update is complete.

How to install on Windows 7 system

1. Open **Display Properties**.
Go to **Start, Control Panel, Hardware and Sound, Devices and Printers** and right-click the name of your monitor from the menu.
Alternatively, right-click the desktop and select **Personalize, Display, Devices and Printers**, and right-click the name of your monitor from the menu.
2. Select **Properties** from the menu.
3. Click the **Hardware** tab.
4. Click **Generic PnP Monitor**, and then the **Properties** button.
5. Click the **Driver** tab and the **Update Driver** button.
6. Insert the BenQ LCD Monitor CD-ROM into a CD drive on the computer.
7. In the **Update Driver Software** window, select the option **Browse my computer for driver software**.
8. Click **Browse** and navigate to the following directory: d:\BenQ_LCD\Driver\ (where d is the drive letter designator for the CD-ROM drive).



The drive letter for your CD drive may differ from the example above depending upon your system - it may be 'D:' or 'E:' or 'F:' etc.

9. Select the correct folder name of your monitor from provided driver list, and click **Next**. This will copy and install the appropriate monitor driver files to your computer.
10. Click **Close**.
You may be prompted to restart your computer after the driver update is complete.

Troubleshooting

- ?

The power LED indicator is not on.
- ✓

 - Make the power cord is properly connected to a grounded power outlet and the monitor.
 - Make sure you have pressed the  key.
- ?

The image is blurred.
- ✓

 - Read the instructions in "[Preset display modes](#)" on 24, and then select the correct resolution, refresh rate and make adjustments based on these instructions.
 - Remove the extension cable for the test. It is normal for blurring to occur due to conduction losses in extension cables. You can minimize these losses by using an extension cable with better conduction quality or with a built-in booster.
- ?

Does the blurring only occur at resolutions lower than the native (maximum) resolution?
- ✓

Read the instructions in "[Preset display modes](#)" on 24. Select the native resolution.
- ?

Pixel errors can be seen.
- ✓

One of several pixels is permanently black, one or more pixels are permanently white, one or more pixels are permanently red, green, blue or another color.
- ✓

 - Clean the LCD screen.
 - Cycle power on-off.
 - These are pixels that are permanently on or off and is a natural defect that occurs in LCD technology.
- ?

The image has a faulty coloration. It has a yellow, blue or pink appearance.
- ✓

If the image is still not correct and the OSD also has faulty coloration, this means one of the three primary colors is missing in the signal input. Now check the signal cable connectors. If any pin is bent or broken off, please contact your dealer to get necessary support.
- ?

No image can be seen.
- ✓











If the LED is illuminated in blue and there is a message **Input Not Support** on the screen, this means you are using a display mode that this monitor does not support, please change the setting to one of the supported mode. Please read "[Preset display modes](#)" on 24.
- ?

Faint shadow from the static image displayed is visible on the screen.
- ✓

 - Activate the power management function to let your computer and monitor go into a low power "sleep" mode when not actively in use.
 - Use a screensaver to prevent the occurrence of image retention.
- ?

Is the prompt on the display illuminated in orange?
- ✓

If the LED is illuminated in orange, the power management mode is active. Press any button on the computer keyboard or move the mouse. If that does not help, check the signal cable connectors. If any pin is bent or broken off, please contact your dealer to get necessary support.

-  Is the prompt on the display not illuminated at all?
-  Check the power supply mains socket, the external power supply and the mains switch.
-  The image is distorted, flashes or flickers.
-  Read the instructions in "[Preset display modes](#)" on 24, and then select the correct resolution, refresh rate and make adjustments based on these instructions.
-  You are running the monitor at its native resolution, but the image is still distorted.
-  Images from different input sources may appear distorted or stretched on the monitor running at its native resolution. To have the optimal display performance of each type of input sources, you can use the **Image Ratio** function to set a proper aspect ratio for the input sources. See "[Image Ratio](#)" on 13 for details.
-  The image is displaced in one direction.
-  Read the instructions in "[Preset display modes](#)" on 24, and then select the correct resolution, refresh rate and make adjustments based on these instructions.
-  No sound can be heard from the built-in speakers (for models with speakers only):
 -  • Check whether Line In is properly connected.
 -  • Increase the volume (volume may be muted or too low).

Need more help?

If your problems remain after checking this manual, please contact your place of purchase or visit the local website from www.BenQ.com for more support and local customer service.

Specification

GW2406Z

Panel	Model name	GW2406Z
	Driving system	TFT Color LCD
	Viewable Image Size	60.47cm diagonal
	Pixel pitch	0.2745 (H) mm x 0.2745 (V) mm
	Video	R, G, B Analog Interface
	Separate Sync.	H/V TTL
	Display Color	16.7M Colors
	Dot Clock	165MHz
Resolution	Horizontal scan range	30 ~ 83kHz
	Horizontal scan Size(Maximum)	527.04mm
	Vertical scan range	50 ~ 76Hz
	Vertical scan Size (Maximum)	296.46mm
	Optimal preset resolution	1920x1080@60Hz
	Plug & Play	VESA DDC2B
	Input Connector	D-SUB / DP / HDMI
	Input Video Signal	Analog: 0.7Vp-p (standard), 75 OHM, Positive
	Speaker	NA
	Power Source	19V, 2A
	Power Consumption	35W (typical)
		Standby < 0.5 W
	Off timer	0-24 hrs
Physical Characteristics	Connector Type	D-SUB / DP / HDMI
	Signal Cable Type	Detachable
	Adapter Type	ADPC1936
	Dimensions & Weight:	
	Height (with base)	396.4 (mm)
	Width	540.2 (mm)
	Depth	173.6 (mm)
	Weight (monitor only)	3.35 kg
	Wall Mount	100 x 100 mm
Environmental	Temperature:	
	Operating	0°C to 40°C
	Non-Operating	-25°C - +55°C
	Humidity:	
	Operating	10% to 85% (non-condensing)
	Non-Operating	5% to 93% (non-condensing)
	Altitude:	
	Operating	0~ 3658m (0~ 12000 ft)
	Non-Operating	0~ 12192m (0~ 40000 ft)

Preset display modes

Mode	Resolution	H.Frequency	V.Frequency
VGA	640×480@60Hz	31.469	59.940
	640×480@75Hz	37.500	75.00
SVGA	800×600@60Hz	37.879	60.317
	800×600@75Hz	46.875	75.000
XGA	1024×768@60Hz	48.363	60.004
	1024×768@75Hz	60.023	75.029
WXGA+	1280×1024@75Hz	79.976	75.025
Apple, Mac II	1152x870@75Hz	68.681	75.062
MAC MODE SVGA	832×624@75Hz	49.725	74.551
MAC MODE XGA	1024×768@75Hz	60.241	74.927

Plug & Play DDC2B feature

This monitor is equipped with VESA DDC2B capabilities according to the VESA DDC STANDARD. It allows the monitor to inform the host system of its identity and, depending on the level of DDC used, communicate additional information about its display capabilities.

The DDC2B is a bi-directional data channel based on the I2C protocol. The host can request EDID information over the DDC2B channel.