



Google TV

Digital Projector User Manual

Portable Series | GV50

V 1.01

Copyright & disclaimer

Copyright

Copyright © 2024 by BenQ Corporation. All rights reserved. No part of this publication may be reproduced, transmitted, transcribed, stored in a retrieval system or translated into any language or computer language, in any form or by any means, electronic, mechanical, magnetic, optical, chemical, manual or otherwise, without the prior written permission of BenQ Corporation.

The Bluetooth® word mark and logos are registered trademarks owned by Bluetooth SIG, Inc. and any use of such marks by BenQ Corporation is under license.

iOS is a trademark or registered trademark of Cisco in the U.S. and other countries and is used under license.

macOS® is a trademark of Apple Inc., registered in the U.S. and other countries.

Google TV is the name of this device's software experience and a trademark of Google LLC. Google, Android, YouTube, Google Cast and other marks are trademarks of Google LLC.

NETFLIX

Netflix is a trademark of Netflix, Inc.



Manufactured under license from Dolby Laboratories. Dolby and the double-D symbol are registered trademarks of Dolby Laboratories Licensing Corporation.

The terms HDMI, HDMI High-Definition Multimedia Interface, HDMI Trade dress and the HDMI Logos are trademarks or registered trademarks of HDMI Licensing Administrator, Inc.

All other logos, products, or company names mentioned in this manual may be the registered trademarks or copyrights of their respective companies, and are used for informational purposes only.

Disclaimer

BenQ Corporation makes no representations or warranties, either expressed or implied, with respect to the contents hereof and specifically disclaims any warranties, merchantability or fitness for any particular purpose. Further, BenQ Corporation reserves the right to revise this publication and to make changes from time to time in the contents hereof without obligation of BenQ Corporation to notify any person of such revision or changes. This user manual aims to provide the most updated and accurate information to customers, and thus all contents may be modified from time to time without prior notice. Please visit <http://support.benq.com> for the latest version of this manual.

It is the sole responsibility of the user if problems (such as data loss and system failure) occurred due to non-factory installed software, parts, and/or non-original accessories.

Warranty

BenQ warrants this product against any defects in material and workmanship, under normal usage and storage.

Proof of purchase date will be required with any warranty claim. In the event this product is found to be defective within the warranty period, BenQ's only obligation and your exclusive remedy shall be replacement of any defective parts (labor included). To obtain warranty service, immediately notify the dealer from which you purchased the product of any defects.

Important: The above warranty shall be void if the customer fails to operate the product in accordance with BenQ's written instructions, especially the ambient humidity must be in-between 10% and 90%, temperature in-between 0°C and 40°C, altitude lower than 2000 meters, and avoiding to operate the projector in a dusty environment. This warranty gives you specific legal rights, and you may have other rights which vary from country to country.

For other information, please visit www.BenQ.com.

Statement regarding hyperlinks and third-party websites

BenQ is not responsible for the content of the websites or of similar resources, which are maintained and controlled by third parties, that may be linked from this product. Providing links to those websites or to similar resources does not mean that BenQ makes any warranty or representation to their content by expression or by implication.

Any third party content or service preinstalled in this product is provided "as is". BenQ does not, by expression or by implication, make any warrant to the content or to the services provided by third parties. BenQ does not warrant or guarantee that the content or services provided by third parties are accurate, effective, most up-to-date, legal, or complete. Under no circumstances shall BenQ be liable for the content or services provided by third parties including their negligence.

Services provided by third parties may be terminated temporarily or permanently. BenQ does not warrant or guarantee that any content or services provided by third parties are in good condition at any time, and is not liable for the termination of the said content and services.

In addition, BenQ is not involved in any transactions you conduct in the websites or similar resources maintained by third parties.

You should contact the content or service providers for any questions, concerns, or disputes.

BenQ ecoFACTS

BenQ has been dedicated to the design and development of greener product as part of its aspiration to realize the ideal of the "Bringing Enjoyment 'N Quality to Life" corporate vision with the ultimate goal to achieve a low-carbon society. Besides meeting international regulatory requirement and standards pertaining to environmental management, BenQ has spared no efforts in pushing our initiatives further to incorporate life cycle design in the aspects of material selection, manufacturing, packaging, transportation, using and disposal of the products. BenQ ecoFACTS label lists key eco-friendly design highlights of each product, hoping to ensure that consumers make informed green choices at purchase.

Check out BenQ's CSR Website at <http://csr.BenQ.com/> for more details on BenQ's environmental commitments and achievements.

Product carbon footprint (PCF)

The carbon footprint of a product is the estimated carbon emission throughout its entire life cycle. The information may be available on the package or [online](#).

The carbon footprint stated for this product is the current estimate and the actual result may be subject to change due to unforeseen conditions. This means the actual product carbon footprint may be different from the declared statement.

You may not find your product's carbon footprint as it was not available at the time the product was shipped. The information should be online once it's available.



Product support

You are strongly recommended to upgrade the product to the latest firmware version and refer to the most up-to-date user manual to make best use of the product.

This document aims to provide the most updated and accurate information to customers, and thus all contents may be modified from time to time without prior notice. Please visit the website for the latest version of this document and other product information. Available files vary by model.

1. Make sure your computer is connected to the Internet.
2. Visit the local website from Support.BenQ.com. The website layout and content may vary by region/country. Look for the following regularly to get the most up-to-date information.
 - User manual and related document
 - Firmware and application
 - Frequently asked questions

Servicing

- If misuse or other accident occurs, contact qualified service personnel for servicing.
- Contact your place of purchase or visit the local website from [Support.BenQ.com](#) for more support.



Support.BenQ.com

Q&A index

Start with the topics you are interested in:

Setup

How do I set up the projector and turn it on?	
Choosing a location	27
Powering on and initial setup	33

Image adjustment

How do I adjust the focus of the projected image?	
Adjusting projection angle	39
Fine-tuning the image clarity	40
How do I fit the projected image to the screen?	
Keystone	41
Screen Fit	42

Usage

How do I project wirelessly?	
Wireless projection (screen casting)	53
How do I play music via the projector?	
Playing music with your projector	57

Maintenance and product support

What should I do if I don't plan to use the projector for a long time?	
Storing the projector	66

Table of Contents

Copyright & disclaimer	2
Copyright	2
Disclaimer	3
Warranty.....	3
Statement regarding hyperlinks and third-party websites	4
BenQ ecoFACTS	4
Product carbon footprint (PCF).....	5
Product support	5
Servicing	6
Q&A index.....	7
Safety instructions.....	12
Package contents.....	17
Introduction	18
Projector overview	18
Overview	18
Keypad	20
I/O ports.....	21
Dimensions.....	22
Projector connections	23
Wireless connection	23
Wired connection (USB-A port)	23
Wired connection (HDMI port)	23
Wired connection (USB-C port)	23
Remote control	25
Remote control effective range.....	26
Setting to power on projector by remote control	26
Installation	27
Choosing a location	27
Obtaining a preferred image size	29

Projection dimensions	29
Using the projector in an outdoor setting	30
Using the projector at high altitude	30
Power supply	31
Charging the battery	31
Battery power check	32
Getting started	33
Powering on and initial setup	33
Power LED indicator	34
Power settings and options for saving power	35
Shutting down the projector	36
Accessing helpful BenQ apps	37
Apps downloaded to your projector	37
Download SmartRemote for BenQ Projector app to your mobile device	37
Upgrading your projector	38
Updating the operating system	38
Advanced firmware updating	38
Adjusting the projected image	39
Adjusting projection angle	39
Fine-tuning the image clarity	40
Fitting the image to your screen	41
Keystone	41
Screen Fit	42
Obstacle avoidance	42
Projection size and position adjustment (Digital zoom and image shift) ..	43
Image rotation	43
Projection onto ceiling	44
Adjustment for side projection	44
Adjusting screen brightness	45

Activating smart eye protection.....	46
Changing the input source	46
Watching streaming videos.....	47
Google TV home screen	47
Dashboard.....	48
Choosing a proper picture mode for video streaming.....	49
Setting picture color according to the wall color	50
Choosing a proper sound mode for video streaming.....	50
Watching bedtime movies.....	51
Setting up a sleep timer.....	51
Projection.....	53
Wireless projection (screen casting)	53
Screen casting from iOS/macOS device devices	53
Screen casting from Android™ OS devices with Google Cast™	54
Screen casting from Android OS devices with Google Home.....	54
Screen casting from PC devices with Google Cast	55
Wired projection.....	56
Playing music with your projector	57
Making your projector a Bluetooth speaker	57
Connecting the projector to an external Bluetooth speaker / headphone.....	58
Making your projector a wireless speaker.....	58
Turning the screen off during music playback.....	59
Playing multimedia files from a USB flash drive.....	60
Power delivery to a USB-C device	61
USB-C power delivery notice.....	61
Menu navigation	62
Set your device name.....	62
Projector	62
Display & Sound	64

Network & Internet	65
Accounts & sign-in	65
Privacy	65
Apps	65
System.....	65
Remotes & Accessories	65
Maintenance	66
Care of the projector.....	66
Cleaning the lens.....	66
Storing the projector	66
Transporting the projector	67
Light source information	67
Troubleshooting	68
Specifications	71
Projector specifications	71
Timing chart.....	73
Video timings	74
Supported file formats	74
Video	74
Audio.....	76
Appendix.....	78
Working with a tripod (purchased separately)	78

Safety instructions

Your projector is designed and tested to meet the latest standards for safety of information technology equipment. However, to ensure safe use of this product, it is important that you follow the instructions mentioned in this manual and marked on the product.

1. Please read this user manual before you operate your projector.
Keep this manual in a safe place for future reference.

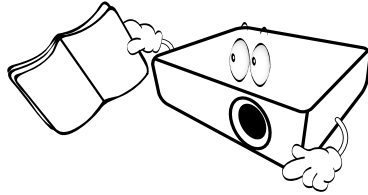

2. Always place the projector on a level, horizontal surface during operation.
 - Do not place the projector on an unstable cart, stand, or table as it may fall and be damaged.
 - Do not place inflammables near the projector.
Do not use if tilted at an angle of more than 10 degrees left to right, nor at angle of more than 15 degrees front to back.

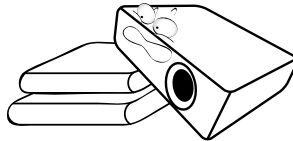

3. Do not store the projector on end vertically. Doing so may cause the projector to fall over, causing injury or resulting in damage.

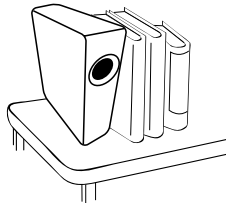

4. Do not place this projector in any of the following environments.
 - Space that is poorly ventilated or confined. Allow at least 50 cm clearance from walls and free flow of air around the projector.
 - Locations where temperatures may become excessively high, such as the inside of a car with all windows rolled up.
 - Locations where excessive humidity, dust, or cigarette smoke may

contaminate optical components, shorten the projector's lifespan and darken the screen.

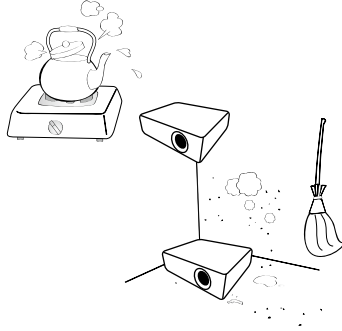

- Locations near fire alarms.
- Locations with an ambient temperature above 40°C /104°F
- Locations where the altitudes are higher than 2000 m (6562 feet).

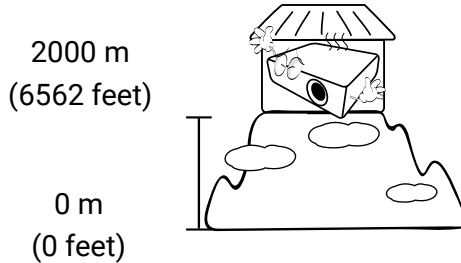

5. Do not block the vents holes while the projector is on (even in power-saving mode).
 - Do not cover the projector with any item.
 - Do not place the projector on a blanket, bedding or any other soft surface.

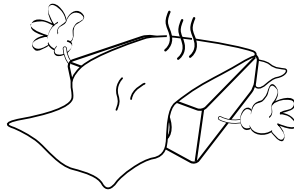

6. In areas where the mains power supply voltage may fluctuate by ± 10 volts, it is recommended that you connect the projector through a power stabilizer, surge protector or uninterruptible power supply (UPS) as appropriate to your situation.

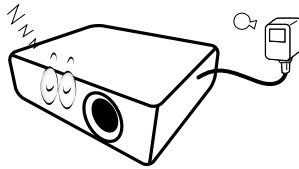

7. Do not step on the projector or place any objects upon it.

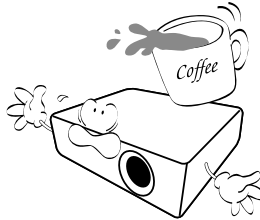

8. Do not place liquids near or on the projector. Liquids spilled into the projector will void your warranty. If the projector does become wet, disconnect it from the power point and call BenQ to have the projector repaired.

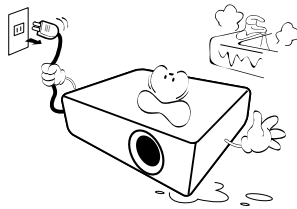

9. Do not look straight into the projector lens during operation. It may harm your sight.

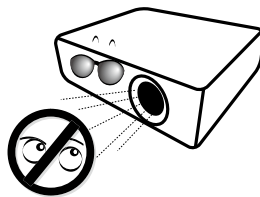

10. Do not operate the projector laser beyond the rated laser life.

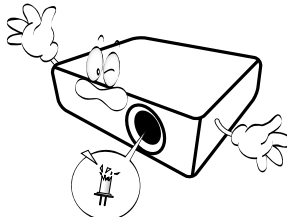

11. Do not attempt to disassemble this projector. There are dangerous high voltages inside which may cause death if you should come into

contact with live parts.

Under no circumstances should you ever undo or remove any other covers. Refer servicing only to suitably qualified professional service personnel.

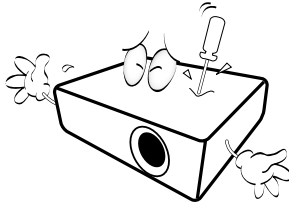

Warning

- Please keep the original packing for possible future shipment.
- If you need to pack your projector after use, adjust the projection lens to an appropriate position, put the lens cushion around the lens, and fit the lens cushion and projector cushion together to prevent damage during transportation.

12. When you think service or repair is required, take the projector only to a suitably qualified technician.

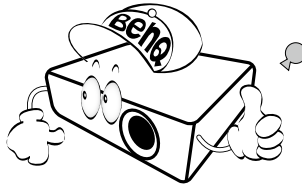

Moisture condensation

Never operate the projector immediately after moving it from a cold location to a hot location. When the projector is exposed to such a change in temperature, moisture may condense on the crucial internal parts. To prevent the projector from possible damage, do not use the projector for at least 2 hours when there is a sudden change in temperature.

Avoid volatile liquids

Do not use volatile liquids, such as insecticide or certain types of cleaner, near the projector. Do not have rubber or plastic products touching the projector for a long time. They will leave marks on the finish. If cleaning with a chemically treated cloth, be sure to follow the cleaning product's safety instructions.

Disposal

This product contains the following materials which are harmful to human bodies and environment.

- Lead, which is contained in solder.

To dispose of the product, consult your local environment authorities for regulations.

Note

- The illustrations and the images shown in this document are for your reference.
- The actual content may vary by the product supplied for your region.

Package contents

Carefully unpack and verify that you have all of the items shown below. Some of the items may not be available depending on your region of purchase. If any of these items are missing, please contact your place of purchase.

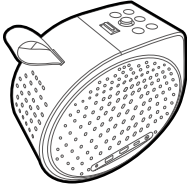

Projector



Base

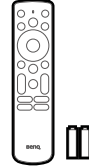

Remote control
(With two AAA batteries)



Power adapter



Power cord
(Varies by region)



User documents

Note

- Actual product's features and specifications are subject to change without notice.
- Some of the accessories may vary by region.
- The warranty card is only supplied in some specific regions. Please consult your dealer for detailed information, or check warranty information online.
- Use original accessories to ensure compatibility.
- Power cord plug type may change based on regional requirements.

Introduction

Projector overview

Overview

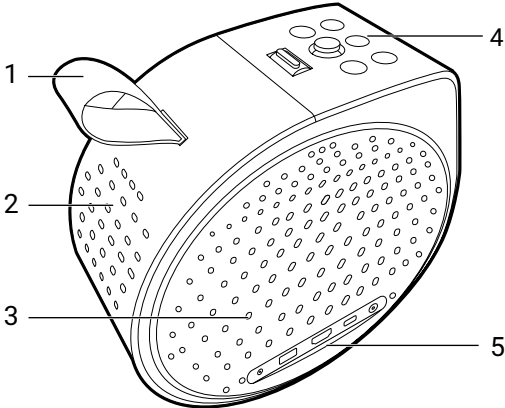

No.	Descriptions
1.	Strap
2.	Top speaker
3.	Right speaker and vents
4.	Keypad See " Keypad " on page 20 for details.
5.	I/O ports <ul style="list-style-type: none">• See "I/O ports" on page 21 for details.• See "Projector connections" on page 23 for details.

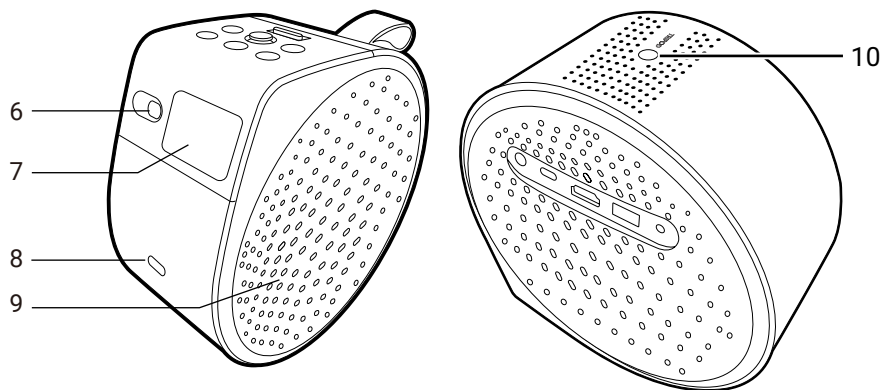

No.	Descriptions
6.	IR remote sensor and Time of Flight (ToF) sensor
7.	Projection lens
8.	Auto focus camera
9.	Left speaker and vents
10.	Tripod screw hole See " Working with a tripod (purchased separately) " on page 78 for details.

Keypad

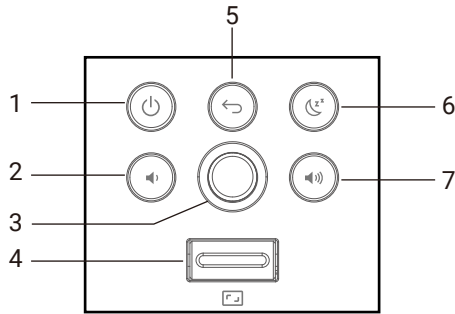

No.	Descriptions
1.	Power key
2.	Volume down button
3.	Joystick
4.	Digital zoom lever See " Projection size and position adjustment (Digital zoom and image shift) " on page 43 for details.
5.	Back key
6.	Sleep timer key See " Setting up a sleep timer " on page 51 for details.
7.	Volume up key

Note

The keypad backlight is always on by default. To turn off the keypad backlight, go to  > **All settings > Projector > Advanced Settings > More > Keypad Backlight always on.**

I/O ports

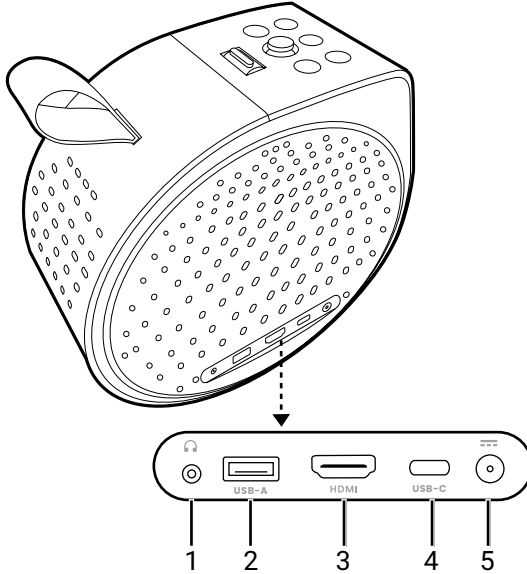

No.	Descriptions
1.	3.5mm audio output jack
2.	USB Type-A port See the following for details. <ul style="list-style-type: none">• "Advanced firmware updating" on page 38• "Playing multimedia files from a USB flash drive" on page 60• Power supply. See "Specifications" on page 71.
3.	HDMI port (version 2.0b) See "Wired connection (HDMI port)" on page 23 for details.
4.	USB Type-C port See the following for details. <ul style="list-style-type: none">• "Power supply" on page 31• "Wired projection" on page 56• "Playing multimedia files from a USB flash drive" on page 60• "Power delivery to a USB-C device" on page 61
5.	Power adapter port

Dimensions

Without Base: 107.0 (W) x 193.3 (H) x 191.4 (D) mm (4.21 x 7.54 x 7.61 in)
With Base: 130.0 (W) x 211.2 (H) x 191.4 (D) mm (5.12 x 8.31 x 7.54 in)

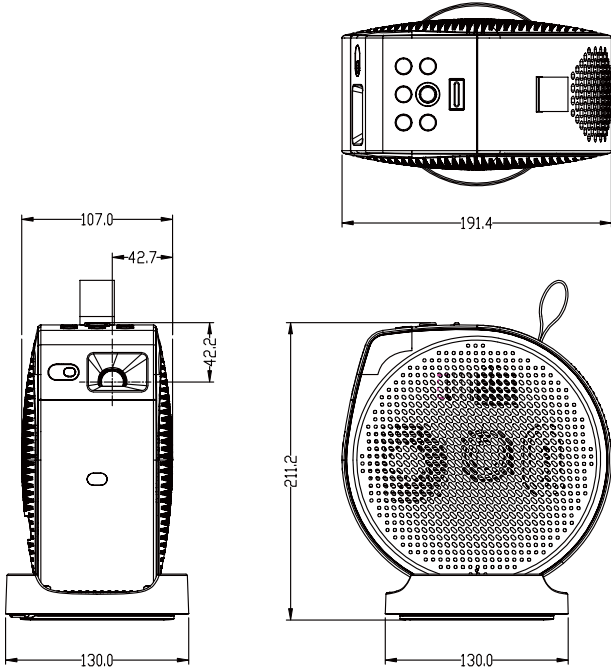

Projector connections

You can connect your device to the projector in various ways to project video content.

Wireless connection

- Smartphone, tablet, laptop/PC (see ["Wireless projection \(screen casting\)" on page 53](#))
- Bluetooth devices (speakers, headphone, mouse, etc.)

Before making any wireless connections, be sure to place the projector within range of the wireless AP you plan to connect it to.

Wired connection (USB-A port)

- USB-A flash drive (see ["Playing multimedia files from a USB flash drive" on page 60](#))

Wired connection (HDMI port)

- A/V device
- Smartphone, tablet, laptop/PC

Wired connection (USB-C port)

- Smartphone, tablet, laptop/PC (see ["Wired projection" on page 56](#))
- Power bank (see ["Power supply" on page 31](#) and ["Power delivery to a USB-C device" on page 61](#))
- USB-C flash drive (see ["Playing multimedia files from a USB flash drive" on page 60](#))

Before making any wired connections, be sure to use the correct cable with corresponding functions (e.g., DP Alt Mode or Power Delivery) for each source and that it is plugged in securely. Connection with USB-C cables/devices certified by USB-IF may increase compatibility.

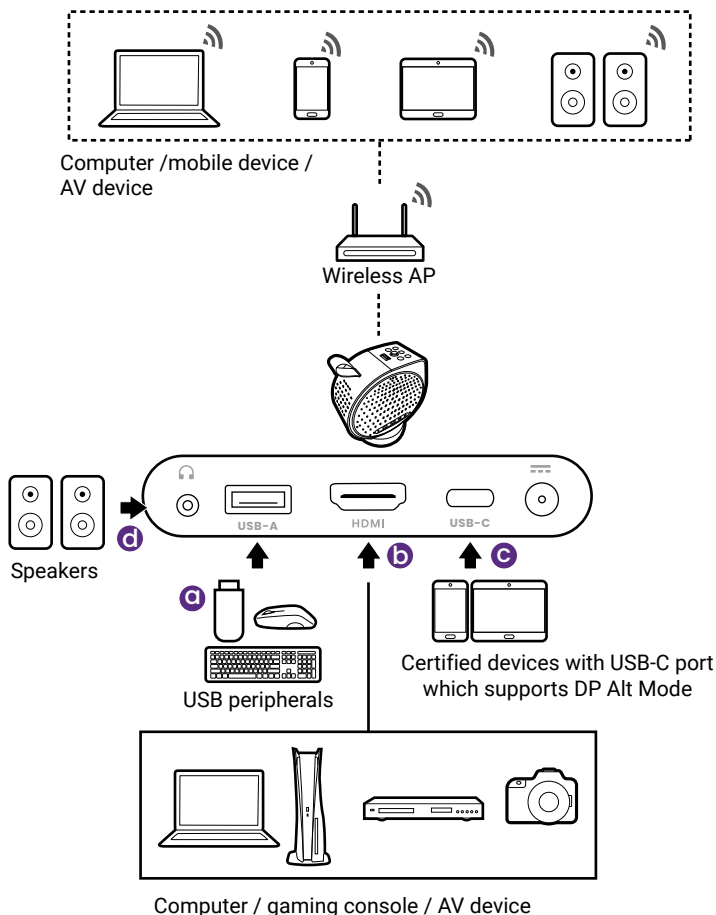

No.	Descriptions	No.	Descriptions
a.	USB flash drive for media reader and peripherals	c.	Certified PD Alt mode USB-C cable
b.	HDMI cable	d.	Audio cable

Note

- In the connections above, some cables may not be included with the projector (see "[Package contents](#)" on page 17). They are commercially available from stores.
- The connection illustrations are for reference only.
- If the selected video image is not displayed after the projector is turned on and the correct video source has been selected, check that the video source device is turned on and operating correctly. Also check that the signal cables have been connected correctly.
- The built-in speaker(s) will be muted when the AUDIO OUT jack is connected.

Remote control

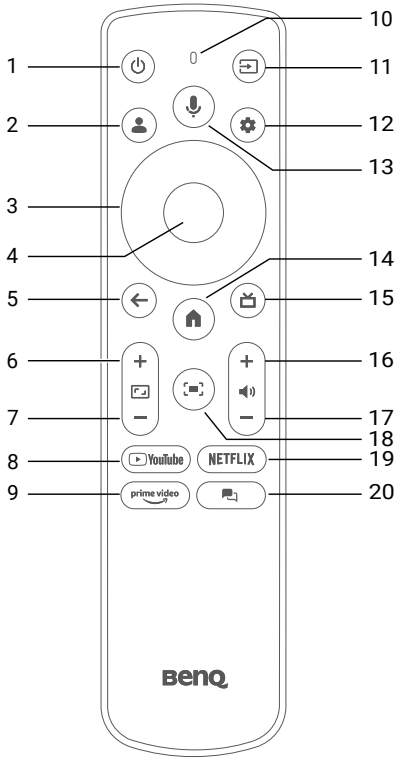

No.	Descriptions
1.	Power
2.	Profiles
3.	Arrow keys
4.	OK
5.	← Back
6.	Digital zoom in
7.	Digital zoom out

No.	Descriptions
8.	YouTube YouTube
9.	prime video Prime Video
10.	Microphone
11.	Source
12.	Dashboard
13.	Voice Search
14.	Google TV home screen
15.	HDMI source
16.	Volume up
17.	Volume down
18.	Screen Adjustment
19.	NETFLIX Netflix
20.	<ul style="list-style-type: none"> Projector Assistant Audio-only mode (See page 59)

Tip

You are provided with **SmartRemote for BenQ Projector** app as an alternative of remote control. Install the app on your mobile device and make it your new remote control. Check "[Accessing helpful BenQ apps](#)" on [page 37](#) for more information.

Remote control effective range

The projector has one IR remote control sensor located at the front of the projector with a range of 8 meters (~26 feet) at an angle of 30 degrees (left and right) and 20 degrees (up and down). Prior to remote control pairing process during the setup wizard (see ["Powering on and initial setup" on page 33](#)), the remote control can only be used either by pointing it directly at the IR sensor or by reflecting the IR signal off of a wall/screen, making sure that there are no obstacles between the remote control and the IR sensor on the projector.

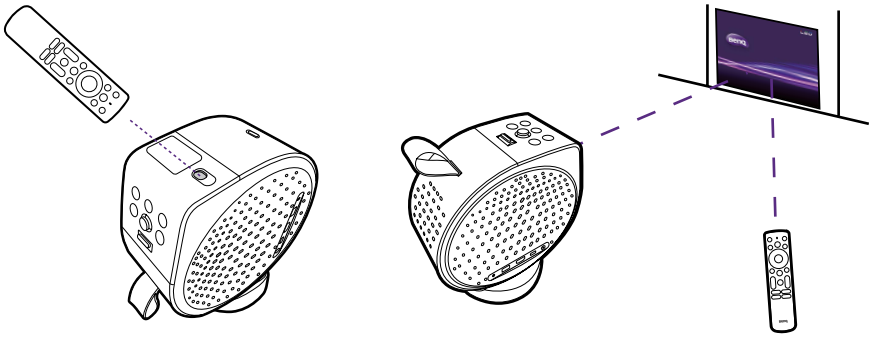

Once the remote control has been paired to the projector, you will be able to use it at any angle within a range of 8 meters (~26 feet).

Note

Voice search functionality on the remote control is only available after the remote control has been paired to the projector. See ["Powering on and initial setup" on page 33](#) for more details.

Setting to power on projector by remote control

Powering on the projector via the remote control is not enabled by default. To enable it, press the **⚙** > **All settings** > **Projector** > **Advanced Settings** > **Remote Control** > **Use remote control to power on**.

Once enabled, the projector scans for remote control signals when it is powered off and may drain battery power gradually.

Installation

Choosing a location

Before choosing an installation location for your projector, take the following factors into consideration:

- Size and position of your screen
- Electrical outlet location
- Location and distance between the projector and the rest of your equipment
- Location and distance between the projector and the wireless access point

You can install your projector in the following ways from **⚙️ > All settings > Projector > Advanced Settings > Projection Mode.**

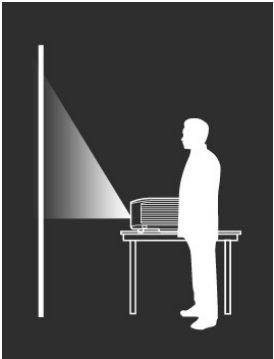
<ul style="list-style-type: none">• Auto Changes projection mode automatically by detecting whether the projector is placed upside down between Front and Front Ceiling by the using scenario (upward or downward). The audio channels are switched accordingly to go with the projector position.	
<ul style="list-style-type: none">• Front Select this location with the projector placed near the floor in front of the screen. This is the most common way to position the projector for quick setup and portability.	

- **Front Ceiling**

Select this location with the projector elevated near the ceiling in front of the screen.

The audio channels are switched accordingly to go with the projector position.

Note

The projector does not feature ceiling mount components/equipment. When choosing to use a ceiling location, you must place it on an elevated and even shelf purchased separately. Make sure the shelf is stable enough to support the projector's weight. Secure the shelf properly and keep the projector from falling.

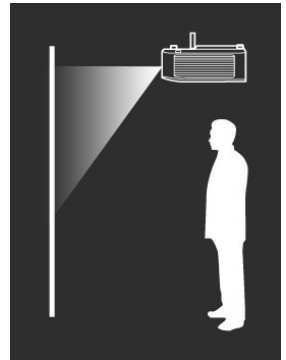

- **Rear**

Select this location with the projector placed near the floor behind the screen.

The audio channels are switched accordingly to go with the projector position.

Note

A special rear projection screen is required.

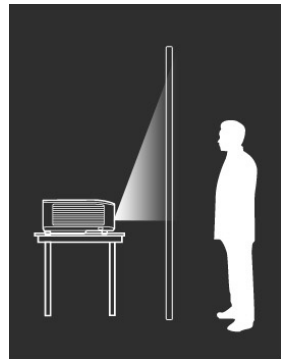

- **Rear Ceiling**

Select this location with the projector elevated from the ceiling behind the screen.

Note

- A special rear projection screen is required.
- The projector does not feature ceiling mount components/equipment. When choosing to use a ceiling location, you must place it on an elevated and even shelf purchased separately. Make sure the shelf is stable enough to support the projector's weight. Secure the shelf properly and keep the projector from falling.

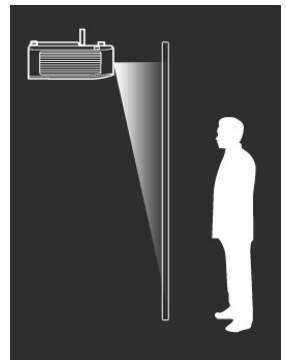

Obtaining a preferred image size

The distance from the projector lens to the screen, the zoom setting, and the video format each factors in the projected image size.

Projection dimensions

The screen aspect ratio is 16:9 and the projected picture is in a 16:9 aspect ratio.

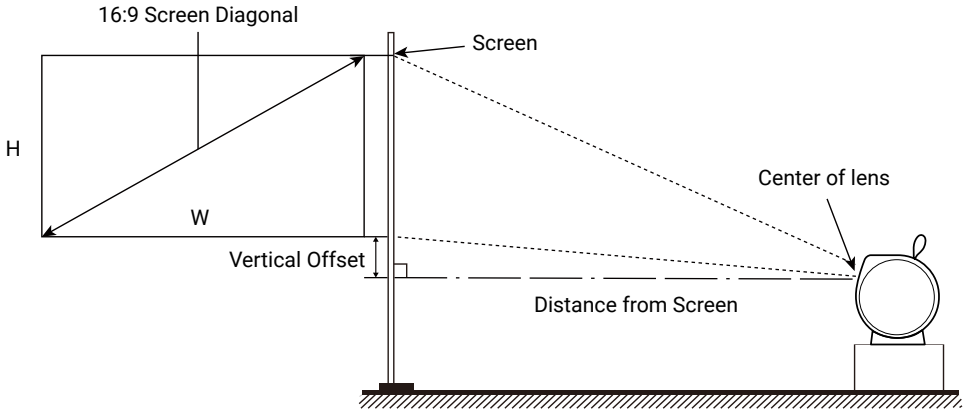

Screen size		W (mm)	H (mm)	Distance from screen (mm)
Inch	mm			
30	762	664	374	797
40	1016	886	498	1063
50	1270	1107	623	1328
60	1524	1328	747	1594
70	1778	1550	872	1860
80	2032	1771	996	2125
90	2286	1992	1121	2391
100	2540	2214	1245	2657
110	2794	2435	1370	2922
120	3048	2657	1494	3188

For example, if you are using a 100-inch screen, the recommended projection distance is 2657 mm.

If your measured projection distance is 2391 mm, the projected screen size is 90-inch.

Note

- All measurements are approximate and may vary from the actual sizes.
- BenQ recommends that if you intend to permanently install the projector, you should physically test the projection size and distance using the actual projector in situ before you permanently install it, so as to make allowance for this projector's optical characteristics. This will help you determine the exact mounting position so that it best suits your installation location.

Using the projector in an outdoor setting

The projector is designed mainly for indoor use but its portable design also allows it to support occasional outdoor use. When using the projector outdoors, the following items are suggested to enhance the viewing experience:

- Install the projector on a tripod if there is no flat surface to place the projector. See "[Working with a tripod \(purchased separately\)](#)" on page 78 for more details.
- Set a preferred picture mode (except **Night Shift**) to the most suitable setting. See "[Choosing a proper picture mode for video streaming](#)" on page 49 for more details.

Using the projector at high altitude

We recommend you use the **High Altitude Mode** when your environment is between 1500 m - 2000 m above sea level, and ambient temperature is between 0°C to 30°C.

Operation under **High Altitude Mode** may cause a higher decibel operating noise level because of increased fan speed necessary to improve overall system cooling and performance.

If you use this projector under other extreme conditions excluding the above, it may display auto shut-down symptoms, which is designed to protect your projector from over-heating.

In cases like this, you should switch to **High Altitude Mode** to solve these symptoms. Go to  > **All settings** > **Projector** > **Advanced Settings** > **More** > **High Altitude Mode**.

However, this is not to state that this projector can operate under any and all harsh or extreme conditions.

Power supply

Supply power to your projector by one of the following methods.

- (Recommended) Via the provided power adapter and power cord.
- Via a power bank / power adapter / USB-C cable with USB-C power delivery function which are all certified by USB-IF and provides at least 45W (20V-2.25A). See PD in information in ["Specifications" on page 71](#) and ["Charging the battery" on page 31](#) for details.
- Via the built-in battery after it is fully charged.

The default screen brightness varies by power supply method. You can manually adjust the brightness as instructed in ["Adjusting screen brightness" on page 45](#).

Note

- The USB-C port is able to provide power to connected devices. See ["Power delivery to a USB-C device" on page 61](#) for more information.
- The USB-A port is able to provide power to connected devices. See ["Specifications" on page 71](#).
- The supplied power adapter is recommended to avoid possible dangers such as electric shock and fire.

Charging the battery

1. Make sure the appropriate plug has been properly assembled, and then connect the adapter to the power adapter port.
2. Connect the power cord to a power outlet.

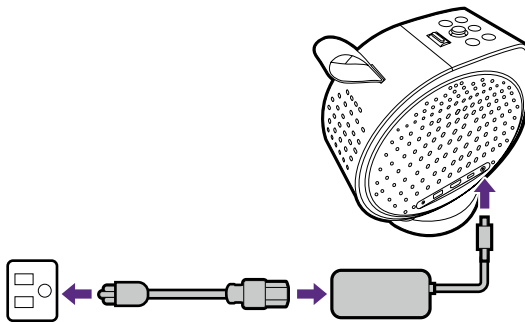

The power LED indicator will illuminate according to its charge status, for a full charge wait until the indicator lights up solid green (see ["Power LED indicator" on page 34](#) for more information on LED behavior). It takes about 3 hours before initial use.

The charging time increases if you prefer to use the projector while charging. Keep the projector in a cool, ventilated place and charge until the

power LED indicator turns solid green. Follow the on-screen instructions if you are prompted to charge the projector in power-off or networked standby mode.

Battery time of a fully charged projector varies according to media content and settings.

Power supply	Projector operation	Battery charging in power-off or networked standby mode	Projector operation & battery charging at the same time
Provided power adapter	Yes	Yes	Yes
USB-C power delivery ranges from 45W (20V-2.25A) to 65W (20V-3.25A)	Yes	Yes	No
USB-C power delivery more than 65W (20V-3.25A)	Yes	Yes	Yes





Note

The default screen brightness varies by power supply method. You can manually adjust the brightness as instructed in ["Adjusting screen brightness" on page 45](#).

Battery power check

To check current battery power, press  > **Battery**.



-  0% ~ 20%
-  21% ~ 39%
-  40% ~ 59%
-  60% ~ 79%
-  80% ~ 100%

Getting started

Powering on and initial setup

1. Choose a preferred location and image size as instructed in ["Choosing a location" on page 27](#).
2. Install the remote control's batteries.

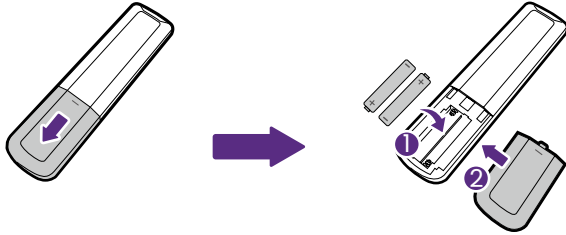

Note

Avoid leaving the remote control and batteries in an excessively hot or humid environment like the kitchen, bathroom, sauna, sunroom or in a closed car.

3. Connect power to the projector. If you are starting up the projector for the first time, charge the battery or supply power to the projector until the power LED lights up in green. See ["Charging the battery" on page 31](#) for more information.

Press and hold the power button  on the projector for 2 seconds. The power LED will flash white slowly.

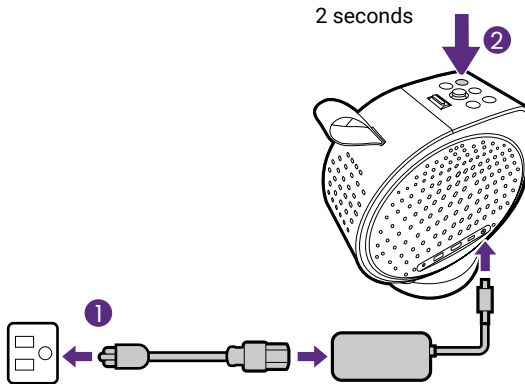

Note

- When supplying power directly to the projector via the supplied power adapter please use the supplied power cable to avoid possible dangers such as electric shock and fire.
 - Prior to pairing the remote control to your projector you must ensure that your remote control is in range of the projector's IR sensor. See "[Remote control effective range](#)" on page 26 for more details.
 - Powering on via the remote control is not enabled by default. To enable it, go to  > **All settings** > **Projector** > **Advanced Settings** > **Remote Control** > **Use remote control to power on**.
 - Powering on via the remote control will not work if you have not completed the setup wizard procedure or if the projector's battery level is below 5%.
4. Follow the on-screen instructions to complete the initial set up. When prompted, select **Set up Google TV** as this will allow you to enjoy the full features Google TV offers.
 5. In next step, select **Set up on TV instead** on the lower part of the screen to access Google TV.
 6. Check if an updated firmware is available for Ayour product. Refer to "[Upgrading your projector](#)" on page 38.
 7. Go for a preferred scenario.
 - "[Watching streaming videos](#)" on page 47
 - "[Projection](#)" on page 53
 - "[Playing music with your projector](#)" on page 57

Power LED indicator

Scenario	LED status	Power status
Turning on/off	Flashing white	Turning on/off properly
	Flashing red	Low battery (below 5%)
Charging with adapter <ul style="list-style-type: none">• Power on: Solid• Networked standby/ Audio only: Breathing	Solid/breathing green	Fully charged
	Solid/breathing red	Charging
Battery mode <ul style="list-style-type: none">• Power on: Solid• Networked standby/ Audio only: Breathing	Solid/breathing green	Battery capacity: 60% - 100%
	Solid/breathing orange	Battery capacity: 21% - 59%
	Solid/breathing red	Battery capacity: < 20%

Power settings and options for saving power

To save power, the projector is switched off or powered off automatically by default.

Time of inactivity	Default setting
15 minutes	The projector enters networked standby mode.
240 minutes	The projector is powered off.

To manually enable networked standby mode, press the power key  on the remote control / projector for 1 second.

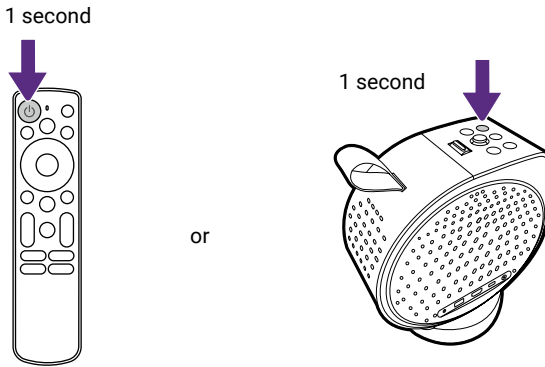

You can change the networked standby setting from  > **All settings** > **System** > **Power & Energy** > **Power & Energy** > **Automatically turn off TV when inactive**. This setting does not power off the projector.

To navigate more power menus, go to  > **All settings** > **System** > **Power & Energy**. Set according to your preferences. Here are some settings under **Power** that may help.

Item	Descriptions
Sleep Timer	Sets to turn off the projector automatically after the set time. See "Setting up a sleep timer" on page 51 for details.

Item	Descriptions
Picture off	Turns off light source. To turn on light source again, press any key.
Switch Off Timer	Sets to power off the projector automatically after the set time.
Auto Sleep	Sets to turn off the projector automatically after the set time of inactivity.

Note

To protect the battery from over-extended networked standby time, the projector is powered off after 4 hours of inactivity by default. If you prefer to extend the standby time, follow the procedures.

1. Go to **⚙️ > All settings > System > Power & Energy > Power & Energy > Automatically turn off TV when inactive** and select **Never**.
2. Go to **⚙️ > All settings > System > Power & Energy > Power > Auto Sleep** and select an option that is more than 4 hours.

Shutting down the projector

Press and hold the power key  on remote control / projector for 2 seconds and the projector will shut down directly.

The power LED will flash white. The fans may continue to run in order to cool the system.

If the projector will not be used for an extended period, unplug the power cable from the power outlet and remove the batteries from the remote control.

Note

If you prefer to switch the projector to networked standby mode automatically, set Auto Sleep first. See ["Power settings and options for saving power" on page 35](#) for details.

2 seconds

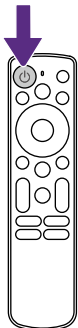

or

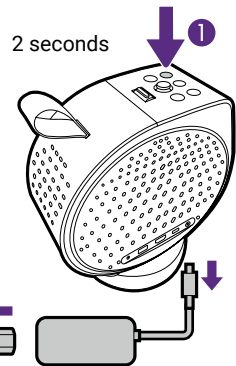

Accessing helpful BenQ apps

You can install certain BenQ apps to extend the functionalities of your projector.

Apps downloaded to your projector

- **BenQ Projector Assistant:** provides tips, FAQs, and product support.
- **Screen Sharing for iOS:** helps cast your content from iOS/masOS device wirelessly. See "[Screen casting from iOS/macOS device devices](#)" on page 53 for more information.

To install apps on your projector, go to the **Apps** tab on the top of your home screen to search for your preferred app.

Download SmartRemoote for BenQ Projector app to your mobile device

SmartRemote for BenQ Projector: pairs your mobile device with the projector to handle basic functions (adjusting volume, moving the directional keys, focusing, etc.), and advanced control of hotkeys for streaming services, text input, and a touchpad, making the usage smarter and more convenient.



Upgrading your projector

It is suggested that you update the projector with the latest version of the firmware to optimize the user experience.

Updating the operating system

When operating system updates are available for your projector, a notification will appear on the Google TV home screen. Follow the on-screen instructions from the notification to complete the update. Notifications will only appear on the home screen when your projector is connected to a wireless network.

Alternatively, go to  > **All settings** > **About** > **System update** to check for update manually.

Advanced firmware updating

If a USB flash drive is required, use one with USB-A connector in FAT32 disk format.

1. Visit [Support.BenQ.com](https://support.benq.com) and download the new firmware files (if available) of your projector. Upgrade procedures may vary by hardware component. Find out the updates and instructions from the upgrade notice. You should download the latest projector user manual for reference as well.
2. Keep stable power supply to the projector via power adapter. Do not power off the projector.
3. The way to perform advanced firmware update may vary. Refer to the firmware upgrade notice for instructions to complete the upgrade.

Adjusting the projected image

Adjusting projection angle

The projector features a base that holds the projector and allows you to adjust the projection angle.

Place the projector properly on the base until it clicks, and rotate the projector to adjust the projection angle.

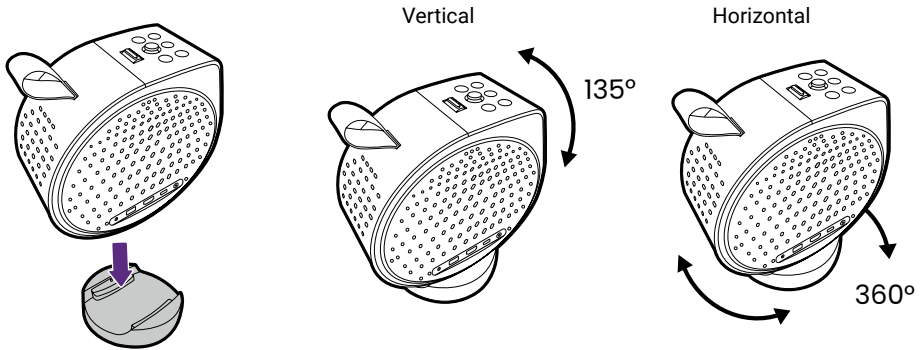

Note

When the projector is on, DO NOT place down the projector with its left or right vents facing down as this will block the vents.

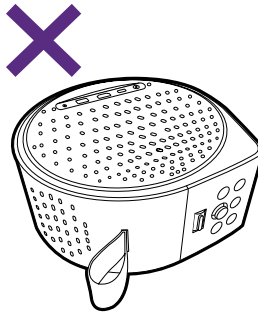

Fine-tuning the image clarity

To sharpen the picture, adjust the focus.

- **Real-time focus & keystone adjustment:** Your projector adjusts focus and keystone automatically at startup by default. This function will be performed automatically as well when the projector is moved. To check/change the auto focus setting, go to **⚙️ > All settings > Projector > Focus > Advanced**. The effective distance from the projection lens to the screen is 0.8 ~ 3.2 meters.
- **One-click screen adjustment:** Press the **⏏** button on the remote control and the projector will automatically focus the image and adjust keystone. Make sure the full keystone pattern is displayed on the screen to ensure a successful correction.

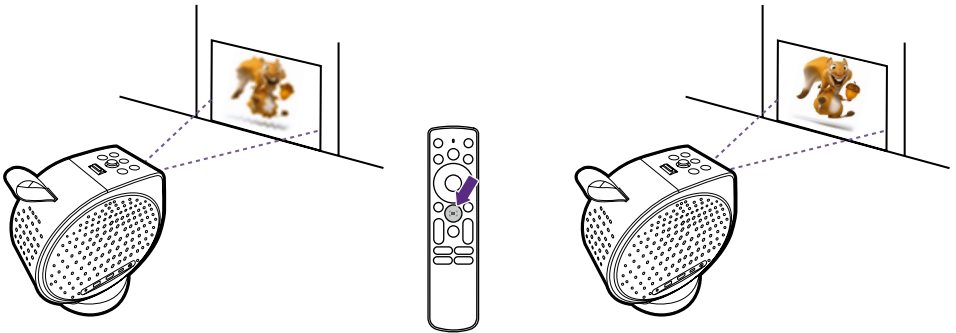

- **Manual focus:** Go to **⚙️ > All settings > Projector > Focus > Manual Focus**. Press up/down keys to make adjustment. When the focus is completed, press **←** to leave.

Note

A focus pattern is displayed to ensure image focus adjustment by default. It is recommended to display the focus pattern for better focus adjustment during video playback in particular. If you prefer not to be distracted by the pattern during adjustment process, you can manually disabled the pattern from **⚙️ > All settings > Projector > Focus > Advanced > Deep Focus Always On**.

Fitting the image to your screen

Keystone

The keystone effect refers to the situation where the projected image is noticeably wider at the top / bottom / left / right. It occurs when the projector is not perpendicular to the screen. The screen automatically performs keystone correction after the projector moves. Make sure the keystone pattern is completely visible on the screen to ensure a successful correction.

- **Real-time focus & keystone correction:** Your projector adjusts focus and keystone automatically at startup if enabled. This function will be performed automatically as well when the projector is moved. To check/change the auto keystone setting, go to **⚙ > All settings > Projector > Image Correction > Advanced**. The effective range of auto keystone is as follows:
 - Vertical: ± 20 degrees
 - Horizontal: ± 30 degrees
 - Rotation: ± 30 degrees
 - Distance from lens to wall: 2 meters

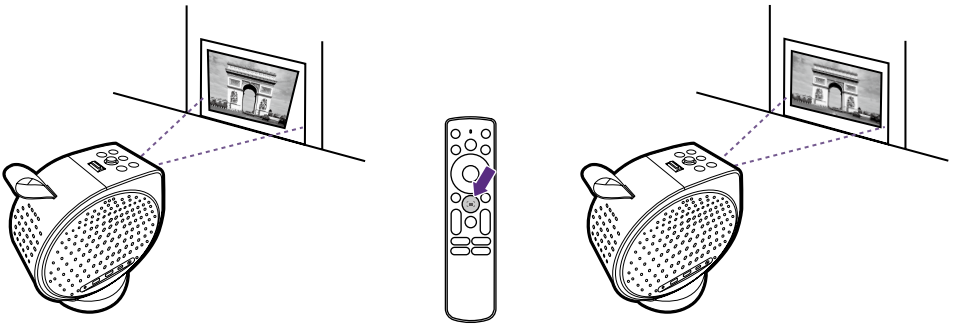

- **One-click screen adjustment:** Press the  button on the remote control and the projector will automatically focus the image and adjust keystone. Make sure the full keystone pattern is displayed on the screen to ensure a successful correction.
- **Manual keystone:** Go to **⚙ > All settings > Projector > Image Correction > Manual Keystone Correction**. Simply follow the on-screen instructions to make adjustments. When the adjustment is completed, press **←** to save your changes and return to the previous

menu.

Note

The way to adjust keystone varies by projection distance and the displayed pattern varies accordingly. This will not change the corrected result, however.

Screen Fit

If the projector is placed off-centered, the image may be distorted and exceeded your screen. With the Screen Fit function, you can adjust the image to align with 4 borders of the screen to fit the screen properly. Note that Screen Fit function works only when all screen borders are detected by the focus/keystone camera.

1. Make sure the projection covers the whole screen and is larger than the screen.
2. Make sure the auto keystone function is enabled from **⚙️ > All settings > Projector > Image Correction > Advanced > Auto Keystone Correction After Movement.**
3. Go to **⚙️ > All settings > Projector > Image Correction > Fit to Screen.**
4. Follow the on-screen instructions. Make sure the full keystone pattern is displayed on the screen to ensure a successful correction. The projection will fit into the screen automatically.

Tip

To perform this function automatically, go to **⚙️ > All settings > Projector > Image Correction > Advanced > Auto fit to Screen.** Toggle the switch on.

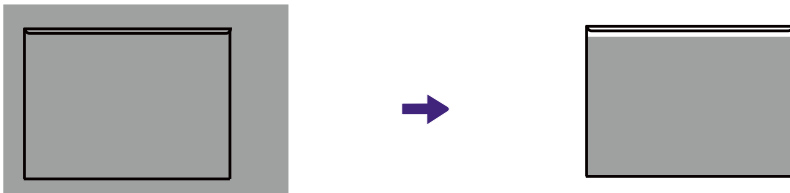

Obstacle avoidance

With this function, the projector detects if the screen is shaded by any object, and resizes the projected image automatically to avoid the object.

1. Make sure the auto keystone function is enabled from **⚙️ > All settings > Projector > Image Correction > Advanced > Auto Keystone Correction After Movement.**
2. Go to **⚙️ > All settings > Projector > Image Correction > Advanced**

> **Avoid Obstacles.** The projector will automatically resize to avoid the object shading the screen. Make sure the full keystone pattern is completely displayed on the screen to ensure a successful correction.

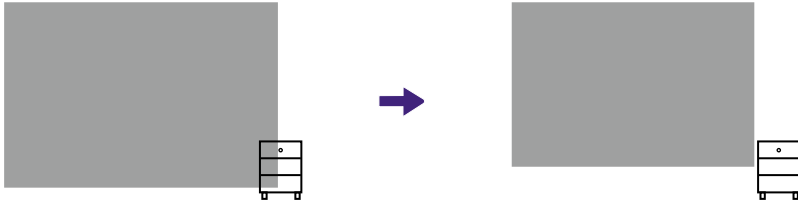



Note

Auto fit to Screen and **Avoid Obstacles** functions cannot work together. The correction result will base on **Avoid Obstacles**.

Projection size and position adjustment (Digital zoom and image shift)

Resize and shift the projected image to fit your space with the digital zoom and reposition functions easily.

1. To resize a image to a smaller space, move the digital zoom lever  or the digital zoom in/out keys on the remote control. The maximum size is the image you projected in the first place.
2. Press OK to switch to image reposition function. Use the arrow keys on the remote control or the joystick on projector to move the image. Follow the on-screen instructions to switch between digital zoom and image reposition.
3. Press  to save and exit.

Tip



To access the menu, go to  > **All settings** > **Projector** > **Image Correction** > **Zoom & Shift**.

Image rotation

Use the image rotation function to fit your room layout or viewing angle as you lie down comfortably on the bed.

1. Go to  > **All settings** > **Projector** > **Image Correction** > **Image Rotation**.
2. Follow the on-screen instructions to rotate the image.
3. Press  to save and exit. Or press and hold OK to reset.

Projection onto ceiling

Adjust the projector to project your image onto ceiling as instructed in "Adjusting projection angle".

Work with more screen adjustment functions to fine tune your projection.

- "Projection size and position adjustment (Digital zoom and image shift)"
- "Image rotation"

Adjustment for side projection

With base tilt design, the projector placed on your bedside table can project image to a desired space on the ceiling right above you. This is helpful if you prefer to watch bedtime movies.

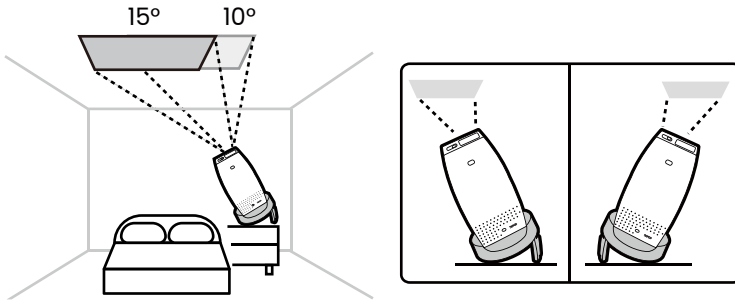

1. Pull out the adjustable feet from the bottom of your projector base.

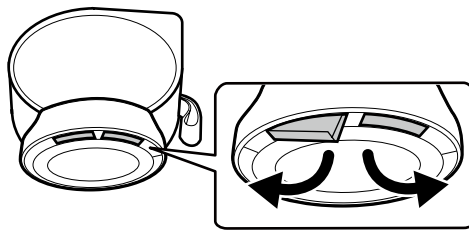

2. Adjust the feet to the desired angle as two tilt angles are provided. Place the base and the projector carefully on the table to check the projection angle.

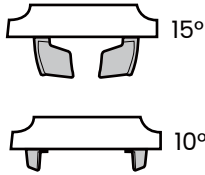

Tip

For more adjustments for bedtime movies, see ["Watching bedtime movies"](#) on page 51.

Adjusting screen brightness

Go to > **All settings** > **Display & Sound** > **Picture** > **Brightness**.

Item	Descriptions	Peak brightness
Auto	Detects the power supply voltage and adjusts screen brightness accordingly. For instance, with the power adapter connected, the screen's peak brightness is 100% by default. You can decrease brightness from ECO or Custom .	
	• Supplied adapter	100%
	• Built-in battery	70%
	• Built-in battery with battery power lower than 20%	20%
	• Power bank / power adapter via USB-C that ranges from 45W (20V-2.25A) to 65W (20V-3.25A)	20%
	• Power bank / power adapter via USB-C that is more than 65W (20V-3.25A)	100%
ECO	Reduces 80% of current peak brightness.	
Custom	10 levels of brightness are provided to decrease the current peak brightness.	

Activating smart eye protection

This function reduces the screen brightness when an object/person is detected within 2 meters in front of the projection lens.

To activate this function, go to  > **All settings** > **Projector** > **Advanced Settings** > **Smart Eye Protection**.

Changing the input source

By default, the projector will display the Google TV home screen any time it is powered on.

Connect a device to one of the projector's input ports. Press the source key  on the remote control and select the desired input source from the source menu.

You can also press the home button  on the remote control to return to the Google TV home screen at any time.

Note

A USB flash drive is not considered as an input source. To play files from a USB flash drive, see ["Playing multimedia files from a USB flash drive" on page 60](#).

Watching streaming videos

Make sure the projector has been connected to a wireless network and you are signed into your Google Account.

Google TV home screen

Upon initial startup or when you press the  key on the remote control, the projector will display the Google TV home screen.

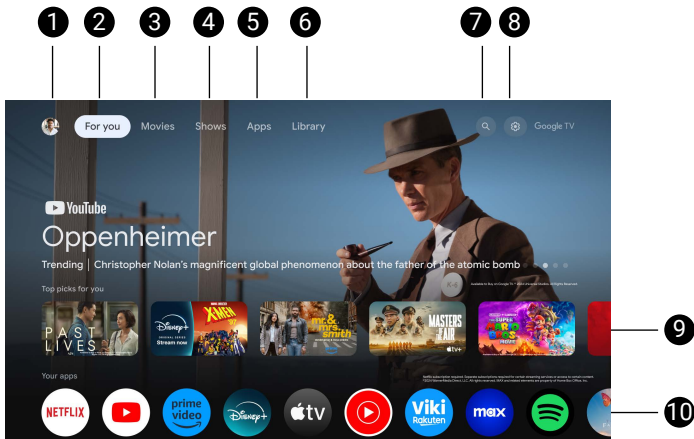

Note

Actual screen and features may vary depending on your country/region.

No.	Item	Description
1	Profile	Signed-in profile.
2	For You	Access to home screen.
3	Movies	Browse a variety of movies.
4	Shows	Explore an assortment of shows.
5	Apps	Download new apps or access installed apps.
6	Library	Access to your personalized watchlist.
7	Search	Enables text input to search.
8	Dashboard	Quick access to setting menu and certain functions (See page 48).

No.	Item	Description
9	Recommendations	Discover movies and shows from across your apps with personalized suggestions.
10	Your Apps	Browse your installed apps.

Dashboard

Use the side panel dashboard to quickly access certain functions and settings.

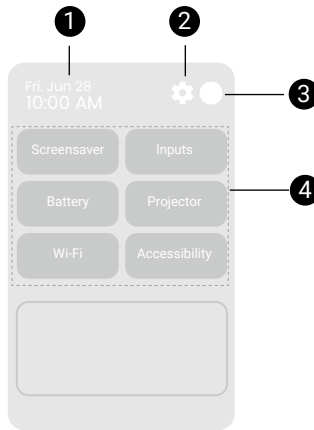

No.	Item	Descriptions
1	System time	Displays the time.
2	Settings	Access to settings menus.
3	Profiles	Switch to different user profiles.
4	Default frequently used menus	Access to frequently used menus/functions.

Note

Actual screen may vary by the availability of network and Google TV version. It may also subject to change without prior notice.

Choosing a proper picture mode for video streaming

You are provided with a variety of picture modes for different scenarios in **Picture Mode**. Go to  > **All settings** > **Display & Sound** > **Picture** for selection. Usually **Cinema** is recommended for watching movies. Available options vary by content. When HDR & HLG content is available, some options under **Picture** support HDR & HLG content. Compared to its standard picture mode, an HDR mode helps deliver High Dynamic Range effects with higher contrasts of brightness and colors.

Option	Descriptions
Vibrant / HDR-Vibrant	With well-saturated colors and fine-tuned sharpness, this mode is slightly brighter than Cinema mode and suitable for playing streaming shows.
Cinema / HDR-Cinema	With accurate colors and deepest contrast level, this mode is suitable for playing movies.
Night Shift / HDR-Night Shift	Adjusts the screen colors to a warmer color temperature to reduce eye strain. This mode is optimized for use in lit or dark spaces, e.g., movie time before bed.
Game / HDR-Game	Picture settings appropriate for playing party video games. This mode also enhances details in dark scenes so that enemies cannot hide. Note When the input source is HDMI/USB-C and this mode is selected, you are provided with two options: <ul style="list-style-type: none">• Game Standard / HDR-Game Standard• Game Boost / HDR-Game Boost Select Game Boost / HDR-Game Boost to enhance your gaming experience. In this case, all image correction settings are reset to factory defaults and the latency is reduced to ultra-low latency (22.4 ms at 1080P 60Hz).
Bright	Maximizes the brightness of the projected image. This mode is the brightest mode on your projector.
HLG	Optimized for HLG-compatible movies with refined color/ sharpness/ contract settings.

Option	Descriptions
Custom / HDR-Custom / HLG-Custom	Customize color settings according to your preference.

Setting picture color according to the wall color

If the image is projected to a colored wall, adjust the picture color for appropriate color representation. Go to **⚙️ > All settings > Display & Sound > Picture > Expert Settings > Wall Color** for selection.

Choosing a proper sound mode for video streaming

In general, you can select a sound mode from **Sound Mode** to suit your scenario. Go to **⚙️ > All settings > Display & Sound > Sound** for selection. Usually **Cinema** is recommended for watching movies.

Option	Descriptions
Cinema	This mode balances the background music and movie sound effect and especially enhances stereo bass sound effect for explosive action scene, such as gunshots and firefights. That's why this mode is suitable for various type of movies, such as serious drama, musical and comedy.
Ceiling Cinema	This mode is optimized for movie times before bed. It balances the high and the low frequencies when the projector is adjusted for projection onto ceiling. Cinematic bass is increased as well to improve sound effect when you are lying down and receive audios at a lower height.



Option	Descriptions
Music	This mode emphasizes total balance (low, middle, high frequency) to fully display the timbre of musical instrument, rhythm of symphony and solos of singer in the hot concert or in live hall for different type of music, like pop, rock, and jazz. To reproduce immersive atmosphere or the presence of sound stage, this mode especially enhances the beat of rhythm instruments, the stereo sound space and the vividness of singer.
Game	This mode not only emphasizes position and spatial dynamism, but also improves sound directivity.

Watching bedtime movies

Project the image onto the ceiling so you can lay back and enjoy bedtime movies.



Follow the instructions in "[Projection onto ceiling](#)" to set up a comfortable corner, and work with sleep timer to switch the projector to networked standby mode automatically.

Change picture and audio modes to better suit the scenario.

- Picture mode:  > **All settings** > **Display & Sound** > **Picture** > **Night Shift**
- Audio mode:  > **All settings** > **Display & Sound** > **Sound** > **Ceiling Cinema**



Setting up a sleep timer

Set to switch the projector to networked standby mode automatically after the set time.

1. Press the  key on the projector to set the timer.
2. Select a preferred time and confirm with the OK key.
3. Press  to save and exit. The  key lights up green when a sleep timer is set.

The set sleep timer is effective once. Set the timer every time when needed.

Note

- When the projector is in standby mode, press the  key to bring the projector back to normal operation.
- To disable the timer, press the  key again and select **Off**.
- For more power options, see "[Power settings and options for saving power](#)" on page 35.

Projection

Wireless projection (screen casting)

To screen cast from your mobile device, tablet or computer to your projector, ensure that both devices are connected to the same wireless network.

Depending on your mobile device, different procedures and options are required. Follow the instructions.

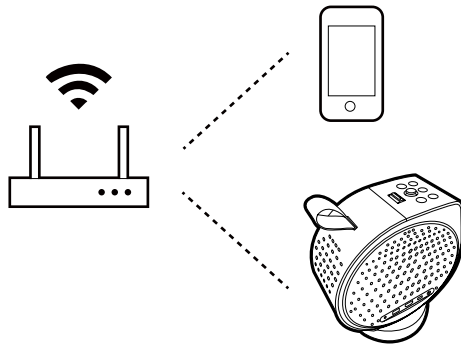

Screen casting from iOS/macOS device devices

1. Install and launch the **Screen Sharing for iOS** app from **Settings > All settings > Projector > Advanced Settings > Screen Sharing for iOS**.
1. Go to **Apps** from the Google TV home screen on the projector, and launch the **Screen Sharing for iOS** app.



2. Follow the on-screen instructions to grant the access right.
3. Make sure your mobile device and the projector are connected to the

same wireless network.

4. Enable the screen mirroring function from your iOS/macOS device. Choose **GV01** (the default device name of your projector) from the device list. If you have changed the name, look for the new name from the device list.

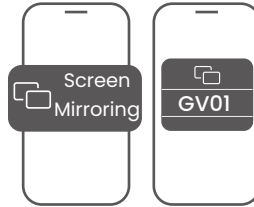

Tip

Some of the streaming apps use portrait screens only and may not be projected on full screen in landscape projection. You can press left / right key to rotate the screen when casting an iOS/MacOS device.

Screen casting from Android™ OS devices with Google Cast™

1. Make sure your mobile device and your projector are connected to the same wireless network.
2. Open a Google Cast-enabled app on your mobile device.
3. Select the content you would like to cast from your mobile device to your projector.
4. Tap the Cast icon (📺) on your mobile device and select **GV01** (the default device name of your projector) as the device you would like to cast to.

Screen casting from Android OS devices with Google Home

1. Make sure your mobile device and the projector are connected to the same wireless network.
2. Go to **Google Play** on your mobile device. Install and launch the **Google Home** app.
3. Follow the on-screen instructions. Select **GV01** (the default device name of your projector) as your cast device from **Google Home** to enable the screen mirroring function from your mobile device. If you

have changed the name, look for the new name from the device list.

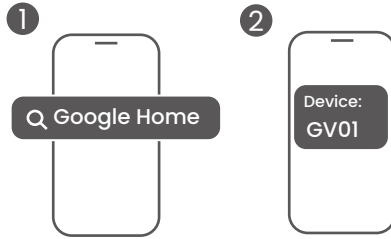

Screen casting from PC devices with Google Cast

1. Make sure your computer and the projector are connected to the same wireless network.
2. Enable the screen mirroring (cast) function from the browser (e.g. Chrome) of your computer. Available name and access to the screen mirroring function may vary by program. Note that the projector is named **GV01** by default. If you have changed the name, look for the new name from the device list.

Windows

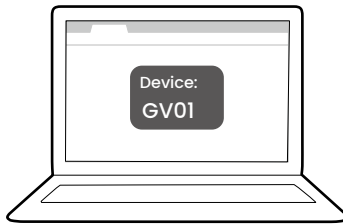



Wired projection

Using an HDMI or certified USB-C 3.0 cable you can connect a device that is equipped with HDMI or DP Alt Mode capabilities to broadcast videos and images on the projector.

Note

Not all devices with a USB-C port have DisplayPort functionality. Check your device's documentation for clarification.

1. Connect the device to the HDMI or USB-C port on the projector with a certified cable.
2. Press the source key , and then select the corresponding port in the source menu.
3. Use the source menu or press the home button  to exit and go back to the Google TV home screen.
4. If the device remains connected and you want to project its video again, press the source button , and then select the corresponding port in the source menu.

Note

- Some computers feature HDMI ports that do not transmit audio, in such cases a separate audio cable must be connected to the projector.
- Some laptops do not turn on their external video ports when connected to a projector. Usually a key combination like Fn + F3 or CRT/LCD key turns the external display on/off. Locate a function key labeled CRT/LCD or a function key with a monitor symbol on the laptop. Press Fn and the labeled function key simultaneously. Refer to your laptop's documentation to discover your laptop's key combination.

Tip

Your projector features video/audio transfer and power delivery from the USB-C port. With this feature, you can charge your gaming console (with USB-C video output) directly during gaming without any other docking. See ["Power delivery to a USB-C device" on page 61](#) for details.

Playing music with your projector

With the built-in speakers, you can enjoy music playback via the projector without a projection screen. The projector can work as an ordinary speaker or a wireless speaker.

Making your projector a Bluetooth speaker

Available when input source is set to Google TV.

1. Go to **⚙️ > All settings > Projector > Bluetooth Speaker Mode** to enable projector's Bluetooth function. The screen is turned off.
2. Enable your device's Bluetooth function as well. Select GV01 (the default device name of your projector) from the device list for pairing. If you have changed the name, look for the new name from the device list.
3. After the pairing is done successfully, you can output the audio from your device to the projector.
4. To stop music playback from the projector and disconnect Bluetooth connection, press any key and press and hold **←**.

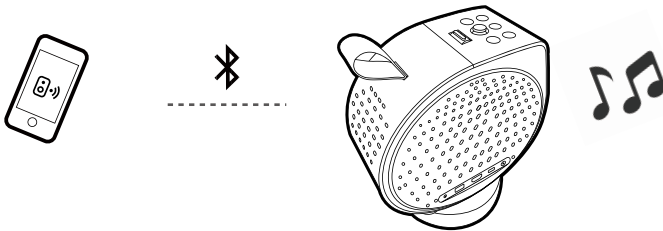

Note

The projector does not support automatic re-connections with previously paired devices. In order to re-connect to a paired device or connect to another device, repeat the steps above.

Connecting the projector to an external Bluetooth speaker / headphone

Available when input source is set to Google TV.

1. Go to  > **All settings** > **Remotes & Accessories** > **Pair accessory** on your projector.
2. Activate Bluetooth-pairing mode on the speaker or headphones.
3. Select the speaker / headphones from the device list.
4. Select **Pair**.
5. Once the projector and speaker / headphones have successfully connected, you can output the audio from your projector to the speaker / headphones.

Note

The projector does not support automatic re-connections with previously paired devices. In order to re-connect to a paired device or connect to another device, repeat the steps above.

Making your projector a wireless speaker

1. Power on the projector (see ["Powering on and initial setup" on page 33](#)).
2. Connect your mobile device and the projector to the same wireless network.
3. Cast your audio from the mobile device to the projector as instructed in ["Wireless projection \(screen casting\)" on page 53](#).
4. Press and hold  on the remote control for 2 seconds to enable audio-only mode. See ["Turning the screen off during music playback"](#) for details.
5. Launch the music app on your mobile device and use the casting function through Google Cast as instructed in ["Wireless projection \(screen casting\)"](#). Find GV01 as the casting device to enjoy music streaming.

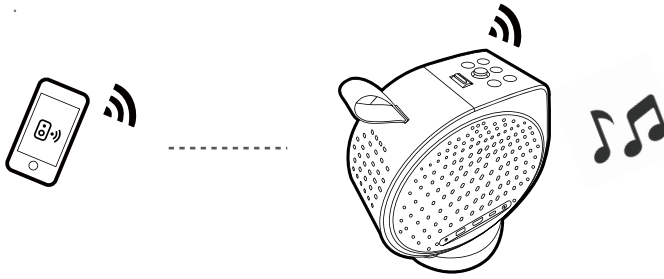

Turning the screen off during music playback

You can enjoy music playback via the projector without a projection screen.

Press and hold the  button on the remote control to switch the projector to audio-only mode. The screen is turned off while the music playback continues.

You can adjust volume by pressing the volume adjustment keys without a projection screen.

To stop the playback or to perform other operations, press any except power, projector assistant key () , volume adjustment keys on the remote control to bring the projection screen back.

Playing multimedia files from a USB flash drive

A media reader app required. Install one before accessing files from a USB flash drive.

To play media files stored on a USB flash drive, you must make connections and settings properly.

1. Connect your USB flash drive to the USB-A / USB-C port of the projector.
2. You are prompted when the USB storage device is detected. Follow the on-screen instructions. On the home screen go to **Apps** > search "media player" and download a preferred app.
3. Launch a media reader app on your projector to access the multimedia files stored on your USB flash drive. Supported file formats for playback may vary by app.

Note

Supported USB flash drive formats: NTFS, FAT, and FAT32.

Power delivery to a USB-C device

Available only when the projector is supplied power via the included power adapter.

With the power delivery function, your projector is able to supply power to a connected USB-C device certified by USB-IF.

Supported USB-C power delivery:

- 5V/2A
- 9V/2A
- 12V/1.5A
- 15V/1.2A

USB-C power delivery notice

- The information is based on the standard testing criteria and is provided for reference. The compatibility is not guaranteed as the user environments vary. When a separately purchased USB-C cable is used, make sure the cable is certified by USB-IF and is full-featured, with power delivery function.
- A connected device needs to be equipped with a USB-C connector that supports charging function via USB power delivery.
- If the connected device requires more than the power supplied by your projector for operation or for boot up (when the battery is drained), use the original power adapter that came with the device.

Menu navigation

To let you make various adjustments or settings on the projector, the projector provides a settings menu. To access the menu, go to  > **All settings**.

Actual menu and options may vary depending on your country/region. Here are some menus related to projector settings. Visit <https://tv.google/> for more information on menus and options.

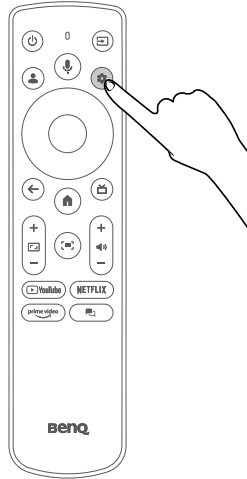

Set your device name

You can change the projector's name if desired.

Projector

 > **All settings** > **Projector**

Item	Options and descriptions
Focus	Decides whether to adjust focus automatically or manually.
Image Correction	Sets to correct keystone and fit the screen.

Item	Options and descriptions
	<p>Auto Keystone Correction Sets to perform keystone correction automatically. See "Keystone" on page 41.</p> <p>Manual Keystone Correction Performs keystone correction manually. See "Keystone" on page 41.</p> <p>Fit to Screen Sets to fit the image to a screen. See "Screen Fit" on page 42.</p> <p>Zoom & Shift Sets to resize or shift the image. See "Projection size and position adjustment (Digital zoom and image shift)" on page 43.</p> <p>Image Rotation Sets to rotate the image to suit your viewing angle. See "Image rotation" on page 43.</p> <p>Reset to Default Image Resets the image adjustments.</p> <p>Advanced Sets to perform image adjustments automatically.</p>
Bluetooth Speaker Mode	Enables the projector's Bluetooth speaker mode. See " Making your projector a Bluetooth speaker " on page 57 and " Connecting the projector to an external Bluetooth speaker / headphone " on page 58.
Advanced Settings	<p>Accesses the advanced projector functions</p> <p>Screen Sharing for iOS Installs or launches the Screen Sharing for iOS app for screen casting from an iOS/macOS device. See "Screen casting from iOS/macOS device devices" on page 53.</p> <p>Smart Eye Protection Sets to lower image brightness when a person is detected near the projection lens to protect eyes. See "Activating smart eye protection" on page 46.</p>

Item	Options and descriptions
	<p>Projection Mode Decides the installation location of your projector. See "Choosing a location" on page 27.</p>
	<p>Remote Control Accesses remote control information, including remote control battery level and firmware upgrade.</p>
	<p>Clear Cache Helps to free memory space to improve projector performance.</p>

Display & Sound

⚙️ > All settings > Display & Sound

Item	Options and descriptions
Picture	Adjusts picture image settings.
	<p>Brightness Sets screen brightness. See "Adjusting screen brightness" on page 45.</p>
	<p>Picture mode Sets a proper picture mode for the content. See "Choosing a proper picture mode for video streaming" on page 49.</p>
	<p>Expert Settings Adjusts settings to enhance image quality.</p>
	<p>Reset to Default Resets image settings to factory defaults.</p>
Sound	Sets a proper sound mode for the content. See " Choosing a proper sound mode for video streaming " on page 50.
Audio Output	Selects the audio format and output delay from the source device connected to the HDMI port. When the digital output setting is Auto , the projector detects the format of input content and set audio format automatically.

Network & Internet

 > **All settings > Network & Internet**

Sets the network connection. You can activate or deactivate wireless connection.

Accounts & sign-in

 > **All settings > Accounts & sign-in**

Manages accounts.

Privacy

 > **All settings > Privacy**

Manages your privacy settings.

Apps

 > **All settings > Apps**

Manages the installed apps.

System

 > **All settings > System**

Accesses device settings.

Remotes & Accessories

 > **All settings > Remotes & Accessories**

You can manually pair a remote via Bluetooth, or manage a paired device.

Maintenance

Care of the projector

Your projector needs little maintenance. The only thing you have to do on a regular basis is keep the lens clean.

Never remove any parts of the projector. Contact your dealer or local customer service center if the projector fails to operate as expected.

Cleaning the lens

Clean the lens whenever you notice dirt or dust on the surface. Please be sure to turn off the projector and let it cool down completely before cleaning the lens.

- Use a canister of compressed air to remove dust.
- If there is dirt or smears, use lens-cleaning paper or moisten a soft cloth with lens cleaner and gently wipe the lens surface.
- Never use any type of abrasive pad, alkaline/acid cleaner, scouring powder, or volatile solvent, such as alcohol, benzene, thinner or insecticide. Using such materials or maintaining prolonged contact with rubber or vinyl materials may result in damage to the projector surface and cabinet material.

Note

Never use wax, alcohol, benzene, thinner or other chemical detergents. These can damage the case.

Storing the projector

If you need to store the projector for an extended time, please follow the instructions below:

- Make sure the temperature and humidity of the storage area are within the recommended range for the projector. Please refer to "[Specifications](#)" on page 71 or consult your dealer about the range.
- Retract the adjustable feet/kickstand (if available).
- Remove the batteries from the remote control.
- Pack the projector in its original packing or equivalent.

Transporting the projector

It is recommended that you ship the projector with its original packing or equivalent.

Light source information

To check the light usage time, go to  > **All settings** > **Projector** > **Advanced Settings** > **More** > **Light Source Information**.

Troubleshooting

 The LED indicator is flashing.

Scenario	LED status
Driver board error	Flashing red/blue
Fan error	Flashing blue/green
Optical engine temperature error	Flashing red
TOF error	Flashing red/green
Battery malfunction	Flashing purple
G sensor Error	Flashing red/blue/green

Contact customer service for assistance.

Note

Refer to "[Power LED indicator](#)" on page 34 for power LED indicator details.

 The projector does not turn on.

Possible cause	Remedy
There is no power from the power cord.	Plug the power cord into the AC power jack on the projector, and plug the power cord into the power outlet. If the power outlet has a switch, make sure that it is switched on.
Attempting to turn the projector on again during the cooling process.	Wait until the cooling down process has completed.

 No picture.

Possible cause	Remedy
The video source is not turned on or connected correctly.	<ul style="list-style-type: none">• Check if the video source is properly connected.• The projector may be in Audio-only or networked standby mode. Press the power key to disable.

Possible cause	Remedy
The projector is not correctly connected to the input signal device.	Check the connection.
The input signal has not been correctly selected.	Select the correct input signal with the  key.

Blurred image

Possible cause	Remedy
The projection lens is not correctly focused.	Adjust the focus of the lens. See " Fine-tuning the image clarity " on page 40.
The projector and the screen are not aligned properly.	Adjust the projection angle and direction as well as the height of the projector if necessary.
The auto vertical keystone function did not work.	Adjust the projection angle.
The ToF sensor is dirty.	Clean the sensor gently with a cleaning cloth. Remove dust or fingerprint carefully.

Remote control does not work.

Possible cause	Remedy
The batteries are out of power	Replace both of the batteries with new ones.
There is an obstacle between the remote control and the projector.	Remove the obstacle.
You are too far away from the projector	Stand within 8 meters (26 feet) of the projector.

 Screen brightness adjustment.

Possible cause	Remedy
The screen is not as bright as expected.	<ul style="list-style-type: none">• The screen brightness changes with power source. See "Adjusting screen brightness" on page 45 for details. To have the full light source brightness, supply power via the provided power adapter or a USB-C power source more than 65W.• Low battery power reduces screen brightness as well. If the power is supplied from the built-in battery, you can check battery power from  > Battery.

Specifications

Projector specifications

Category	Item	Descriptions
Display	Brightness (ANSI lumens)	500
	Native Resolution	1080P (1920x1080)
	Native Aspect Ratio	16:9
	Contrast Ratio (FOFO)	100,000:1
	Display Color	24-bit (16.7 million colors)
	Light Source	Laser
	Light Source Life	Eco: 30000 hours Normal: 20000 hours
Optical	Throw Ratio	1.2
	Zoom Ratio	Fixed
	Lens	F/#=1.9; f=19.65mm
	Projection Offset (Full-Height)	100%
	Keystone Adjustment	2D, (Auto) Vertical ± 20 degrees, Horizontal ± 30 degrees, Rotation ± 30 degrees (distance to the wall by projection direction: within 2M); 2D, (Manual) Vertical & Horizontal & Rotation ± 40 degrees
	Clear Image Size	30" – 120"
Picture	Rec. 709 Coverage	92%
Compatibility	Input Lag	22.4ms (1080p@60Hz)
	Resolution Support	VGA (640 x 480) to 4K UHD (3840 x 2160)
	Horizontal Frequency	15K – 135KHz
	Vertical Scan Rate	22 – 62Hz
	HDTV Compatibility	480p, 576p, 720p, 1080p
I/O Interface	HDMI in	(x1) HDMI-1 (2.0b/HDCP2.3)
	USB Type-A	(x1) USB Type A-1 (2.0/Power Supply 1.0A/Reader/FW Upgrade)
	USB Type-C	(x1) Display Port/ PD in 20V-2.25A to 5A/ PD out 5V-2A, 9V-2A, 12V-1.5A, 15V1.2A*/Reader
Audio	Speaker	(x2) 4W
	Audio out (3.5mm Mini Jack)	(x1)
	HDMI Audio Return	ARC, 5.1 channel
	Woofers	10W Chamber

Category	Item	Descriptions
Environment	Power Supply	AC 100 to 240 V, 50/60 Hz
	Typical Power Consumption	85W@100 – 240VAC
	Power consumption in networked standby /off mode	2W/0.3W
	Acoustic Noise (Typ./Eco.)(dB)	28dBA/26dBA
	Operating Temperature	0 – 40°C
	Storage Temperature	-20 – 60°C, without condensation
	Operating Relative Humidity	10 – 90%RH, without condensation
	Storage Relative Humidity	10 – 90%RH, without condensation
Battery	Battery Cell Type	Lithium-ion
	Battery Life	Video Playing Time: approximately 150 mins Music Playing Time: approximately 300 mins
	Battery Life Cycle	500 Cycles
Mechanical Features	Projection angle (Portable only)	135° Vertical/ 360° Horizontal/ 10°-15° Tilt for ceiling projection
Smart Features	Bluetooth	Bluetooth 5.0
	Wi-Fi Standard	802.11 a/b/g/n/ac (2.4G/5G)
Dimensions and Weight	Net Weight (kg)	2.1 kg
	Net Weight (lb)	4.6lb
	Dimensions (WxHxD) (mm)	130.0(W) x 211.2(H) x 191.4(D)
	Dimensions (WxHxD) (inch)	5.12(W) x 8.31(H) x 7.54(D)
Projections System	Projection System	DLP
	DMD size	0.23" Pico

Note

- The performance of Wi-Fi and Bluetooth might be disturbed by distance and obstacles.
- Battery life may vary by the content played, the media source, or the projector settings.
- *: PD out is available only when the projector is supplied power by the power adapter came with your product.

Supplied power adapter information

The supplied power adapter (external power supply equipment) technical product information:

Product name: AC adapter

Manufacture model: NSA90ED-19047401

Max rating: 90W (19V, 4.74A)

Manufacture:

Shenzhen JingQuanHua&Everrise Intelligent Electric Co., Ltd

Timing chart

Resolution	Mode	Vertical frequency (Hz)	Horizontal frequency (KHz)	Dot Clock Frequency (MHz)
640 x 480	VGA_60	59.94	31.469	25.175
720 x 400	720x400_70	70.087	31.469	28.3221
800 x 600	SVGA_60	60.317	37.879	40
1024 x 768	XGA_60	60.004	48.363	65
1280x720	1280 x 720_60	60	45	74.25
1280 x 768	1280 x 768_60	59.87	47.776	79.5
1280 x 800	WXGA_60	59.81	49.702	83.5
1280 x 1024	SXGA_60	60.02	63.981	108
1280 x 960	1280 x 960_60	60	60	108
1440 x 900	WXGA+_60	59.887	55.935	106.5
1400X1050	SXGA+_60	59.978	65.317	121.75
1600x1200	UXGA	60	75	162
1680x1050	1680x1050_60	59.954	65.29	146.25
1920x1080@60HZ	1920X1080_60 (CEA-861)	60	67.5	148.5
1920X1080(VESA)	1920X1080_60 (for Auditorium model)	59.963	67.158	173
2560x1440@60HZ	2560X1440_60	59.951	88.787	241.5
2560x1600 (VESA)	2560X1600_60	59.987	99.458	348.5
3840x2160	3840x2160_30 (For 4K/2K model)	30	67.5	297
3840x2160	3840x2160_60 (For 4K/2K model)	60	135	594

Note

- USB-C port for alt mode supports up to 1920X1080@60Hz.
- Not all timings are available to the input source connected to the internal HDMI port. See "[Video timings](#)" on page 74 for available timings.

Video timings

Timing	Resolution	Vertical frequency (Hz)	Horizontal frequency (KHz)	Dot Clock Frequency (MHz)
576p	720 x 576	31.25	50	27
720/50p	1280 x 720	37.5	50	74.25
720/60p	1280 x 720	45	60	74.25
1080/24P	1920 x 1080	27	24	74.25
1080/25P	1920 x 1080	28.13	25	74.25
1080/30P	1920 x 1080	33.75	30	74.25
1080/50P	1920 x 1080	56.25	50	148.5
1080/60P	1920 x 1080	67.5	60	148.5
2160/24P	3840 x 2160	54	24	297
2160/25P	3840 x 2160	56.25	25	297
2160/30P	3840 x 2160	67.5	30	297
2160/50P	3840 x 2160	112.5	50	594
2160/60P	3840 x 2160	135	60	594

Note

- USB-C port for alt mode can support up to 1920X1080@60Hz.
- The input source connected to the internal HDMI port supports timings with * mark only.

Supported file formats

Video

MPEG-2 Video Decoder

ISO/IEC 11172-2 MPEG-1 video format decoding

ISO/IEC 13818-2 MPEG-2 video MP@HL and HD level

Supports resolution up to HDTV (1080p60, 1080i, 720p) and SDTV

Supports dual stream decoding for 3D content

Supports for FHDp60 2x fast forwarding playback

MPEG-4 Video Decoder

ISO/IEC 14496-2 MPEG-4 ASP video decoding up to HD level
Supports resolutions up to HDTV (1080p@60fps)
Supports FLV version1 video format decoding
Supports dual stream decoding for 3D content

H.264 Decoder

ITU-T H.264, ISO/IEC 14496-10 (main and high profile up to level 5.2) video decoding
Supports resolution up to 4096x2160@60fps
Supports bitrate up to 135Mbps
Supports resolutions for all DVB, ATSC, HDTV, DVD and VCD
Supports SVAFF 2ES (for Dual Decode)
Supports MVC 3D decoding up to 1080p@60fps

VP8 Decoder

Supports VP8 decoder
Supports resolution up to 1920x1080@60fps
Supports maximum bitrate up to 50Mbps

VP9 Decoder

- Supports VP9 decoder
- Supports 4:2:0 subsampling and 8bit/10bit color depth
- Supports max resolution and frame rate 4096x2160@60fps
- Supports max bitrate up to 100Mbps

AV1 Video Decoder

- Supports AV1 video decoding
- Supports Main profile, level 5.1
- Supports 8-bit/10-bit color depth
- Supports resolution up to 4096x2304@60fps
- Supports max bitrate up to 100Mbps

HEVC (H.265) Decoder

- Supports HEVC/H.265 video decoding
- Supports Main/Main-10 profile, and Scalable Main/Scalable Main-10 profile, level 5.1, high tier

- Supports 8-bit/10-bit color depth
- Supports resolution up to 4096x2160@75fps
- Supports max bitrate up to 100Mbps

Hardware JPEG Decoder

- Supports up to 1920x1080@30fps, 1280x720@60fps
- Supports formats: 422/411/420/444/422T
- Supports scaling down ratios: 1/2x1/2, 1/4x1/4, 1/8x1/8
- Supports both color and grayscale pictures
- Supports sequential mode, single scan
- Supports programmable Region of Interest (ROI)
- Following the file header scan the hardware decoder fully handles the decode process

VC-1 Video Decoder

- Supports SMPTE-421M (VC1 video) decoding up to AP@L3 (2048x1024p60)
- Supports dual stream decoding for 3D content

NTSC/PAL/SECAM Video Decoder

- Supports NTSC-M, NTSC-J, NTSC-4.43, PAL (B, D, G, H, M, N, I, Nc), and SECAM standards
- Automatic standard detection
- Motion adaptive 3D comb filter
- Supports CVBS & Y/C S-video inputs
- Supports Teletext and V-chip

Audio

Multi-Standard TV Sound Processor

- Supports BTSC/A2 demodulation
- Supports NICAM/FM/AM demodulation
- Supports MTS Mode Mono/Stereo/SAP in BTSC mode
- Supports Mono/Stereo/Dual in A2/NICAM mode
- Built-in audio sampling rate conversion (SRC)
- Audio processing for loudspeaker channel, including volume, balance, mute, tone, EQ, virtual stereo/surround and treble/bass controls
- Advanced sound processing options available, for example: Dolby1,

DBX-TV2

- Supports digital audio format: MPEG-1, MPEG-2 (Layer I/II), MP3, AAC-LC, HE-AAC
- Supports Multi-stream programs: Dolby MS12-Y
- Supports Audio Description
- Supports MPEG audio encoding
- Supports time shifting PVR
- Supports programmable delay for audio/video synchronization

Appendix

Working with a tripod (purchased separately)

Use a tripod plate to mount the projector onto a tripod:

1. Install the tripod's quick release plate to the projector's tripod screw hole and tighten the plate's screw. (Screw type: 1/4"-20)

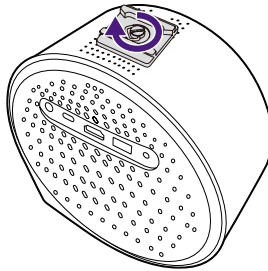

2. Install the projector onto the tripod.

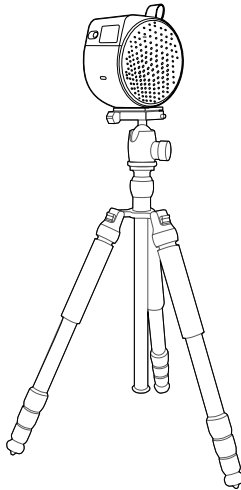

Note

The tripod screw hole on the bottom of your projector is not designed for ceiling mount installation. If you choose a ceiling location for your projector, refer to "[Front Ceiling](#)" on page 28 and "[Rear Ceiling](#)" on page 28 for instructions.



BenQ.com

© 2024 BenQ Corporation.
All rights reserved. Rights of modification reserved.