



Digital Projector User Manual

LW650 / LH650

V 1.00

Warranty and Copyright information

Limited warranty

BenQ warrants this product against any defects in material and workmanship, under normal usage and storage.

Proof of purchase date will be required with any warranty claim. In the event this product is found to be defective within the warranty period, BenQ's only obligation and your exclusive remedy shall be replacement of any defective parts (labor included). To obtain warranty service, immediately notify the dealer from which you purchased the product of any defects.

Important: The above warranty shall be void if the customer fails to operate the product in accordance with BenQ's written instructions, especially the ambient humidity must be in-between 10% and 90%, temperature in-between 0°C and 35°C, altitude lower than 4920 feet, and avoiding to operate the projector in a dusty environment. This warranty gives you specific legal rights, and you may have other rights which vary from country to country.

For other information, please visit www.BenQ.com.

Copyright

Copyright © 2023 by BenQ Corporation. All rights reserved. No part of this publication may be reproduced, transmitted, transcribed, stored in a retrieval system or translated into any language or computer language, in any form or by any means, electronic, mechanical, magnetic, optical, chemical, manual or otherwise, without the prior written permission of BenQ Corporation.

Disclaimer

BenQ Corporation makes no representations or warranties, either expressed or implied, with respect to the contents hereof and specifically disclaims any warranties, merchantability or fitness for any particular purpose. Further, BenQ Corporation reserves the right to revise this publication and to make changes from time to time in the contents hereof without obligation to notify any person of such revision or changes.

*DLP, Digital Micromirror Device and DMD are trademarks of Texas Instruments. Others are copyrights of their respective companies or organizations.

Table of Contents

Warranty and Copyright information	2
Important safety instructions	4
Introduction	8
Shipping contents	8
Projector exterior view	9
Controls and functions	10
Positioning your projector	13
Choosing a location	13
Obtaining a preferred projected image size	14
Mounting the projector	17
Adjusting the projected image	18
Connection	20
Operation	23
Starting up the projector	23
Using the menus	24
Securing the projector	25
Switching input signal	26
Shutting down the projector	27
Menu operation	28
Menu System	28
Basic Menu	28
Advanced Menu	29
Maintenance	46
Care of the projector	46
Light source information	46
Troubleshooting	49
Specifications	50
Projector specifications	50
Dimensions	51
Timing chart	52

Important safety instructions

Your projector is designed and tested to meet the latest standards for safety of information technology equipment. However, to ensure safe use of this product, it is important that you follow the instructions mentioned in this manual and marked on the product.

1. **Please read this manual before you operate your projector.** Save it for future reference.

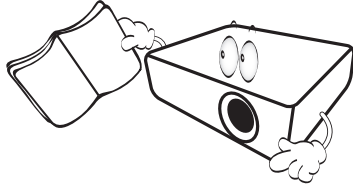

2. **Do not look straight at the projector lens during operation.** The intense light beam may damage your eyes.

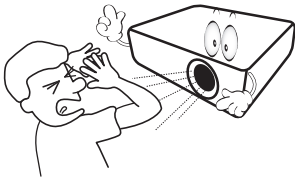

3. **Refer servicing to qualified service personnel.**

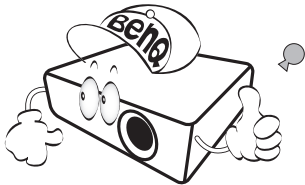

4. **Always open the lens shutter (if any) or remove the lens cap (if any) when the projector light source is on.**
5. The light source becomes extremely hot during operation.

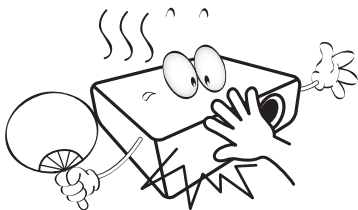

6. In some countries, the line voltage is NOT stable. This projector is designed to operate safely within a mains voltage between 100 to 240 volts AC, but could fail if power cuts or surges of ± 10 volts occur. **In areas where the mains voltage may fluctuate or cut out, it is recommended that you connect your projector through a power stabilizer, surge protector or uninterruptible power supply (UPS).**

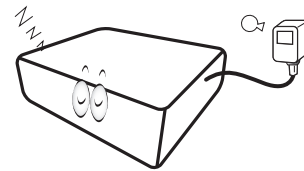

7. Do not block the projection lens with any objects when the projector is under operation as this could cause the objects to become heated and deformed or even cause a fire. To temporarily turn off the light source, use the blank function.

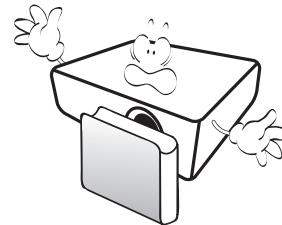

8. Do not operate light sources beyond the rated light source life.

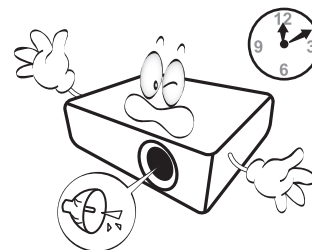

9. Do not place this product on an unstable cart, stand, or table. The product may fall, sustaining serious damage.

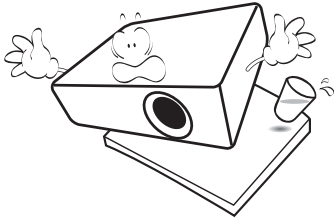

10. Do not attempt to disassemble this projector. There are dangerous high voltages inside which may cause death if you should come into contact with live parts.

Under no circumstances should you ever undo or remove any other covers. Refer servicing only to suitably qualified professional service personnel.

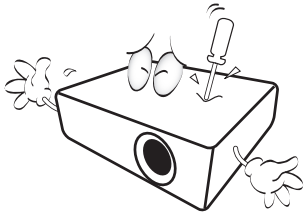

11. Do not block the ventilation holes.

- Do not place this projector on a blanket, bedding or any other soft surface.
- Do not cover this projector with a cloth or any other item.
- Do not place inflammables near the projector.

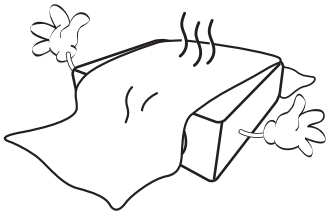

If the ventilation holes are seriously obstructed, overheating inside the projector may result in a fire.

12. Always place the projector on a level, horizontal surface during operation.

- Do not use if tilted at an angle of more than 10 degrees left to right, nor at angle of more than 15 degrees front to back. Using the projector when it is not fully horizontal may cause a malfunction of, or damage to, the light source.

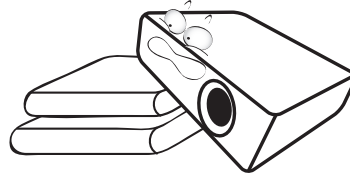

13. Do not stand the projector on end vertically. Doing so may cause the projector to fall over, causing injury or resulting in damage to the projector.

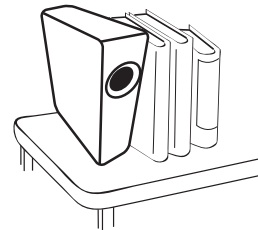

14. Do not step on the projector or place any objects upon it. Besides probable physical damage to the projector, doing so may result in accidents and possible injury.

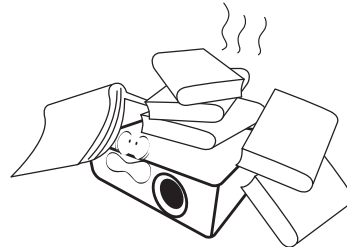

15. When the projector is under operation, you may sense some heated air and odor from its ventilation grill. It is a normal phenomenon and not a product defect.

16. Do not place liquids near or on the projector. Liquids spilled into the projector may cause it to fail. If the projector does become wet, disconnect it from the power supply's power outlet and call BenQ to have the projector serviced.

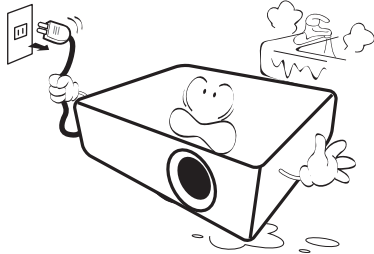

17. This product is capable of displaying inverted images for ceiling/wall mount installation.

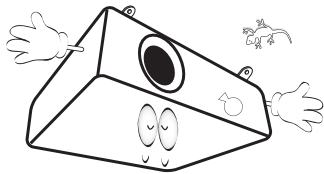

18. This apparatus must be earthed.

19. Do not place this projector in any of the following environments.

- Space that is poorly ventilated or confined. Allow at least 50 cm clearance from walls and free flow of air around the projector.
- Locations where temperatures may become excessively high, such as the inside of a car with all windows rolled up.
- Locations where excessive humidity, dust, or cigarette smoke may contaminate optical components, shorten the projector's life span and darken the image.

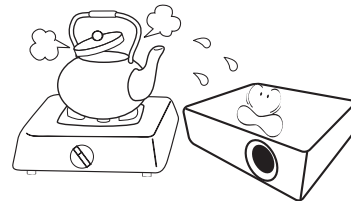

- Locations near fire alarms
- Locations with an ambient temperature above 40°C / 104°F
- Locations where the altitudes are higher than 3000 m (10000 feet).

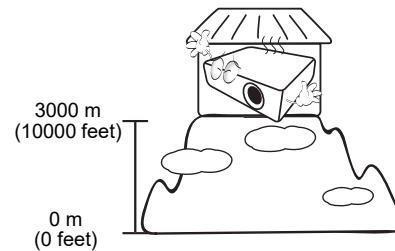

Risk Group 2

1. According to the classification of photobiological safety of light sources and light source systems, this product is Risk Group 2, IEC 62471-5:2015.
2. Possibly hazardous optical radiation emitted from this product.
3. Do not stare at operating light source. May be harmful to the eyes.
4. As with any bright source, do not stare into the direct beam.



The projector's light source unit uses a laser.

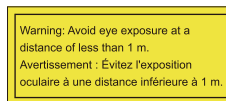

- Notice is given to supervise children and to never allow them to stare into the projector beam at any distance from the projector.
- Notice is given to use caution when using the remote control for starting the projector while in front of the projection lens.
- Notice is given to the user to avoid the use of optical aids such as binoculars or telescopes inside the beam.

Laser Caution

This product belongs to CLASS 1 consumer laser product and complies with IEC 60825-1:2014, EN 60825-1:2014/A11:2021 and EN 50689:2021.



Above laser caution are located on the bottom of this apparatus.

Caution – Use of controls or adjustments or performance of procedures other than those specified herein may result in hazardous radiation exposure.

- ! To avoid damaging the DLP chips, never aim a high-power laser beam into the projection lens.

Introduction

Shipping contents

Carefully unpack and verify that you have all of the items shown below. If any of these items are missing, please contact your place of purchase.

Standard accessories

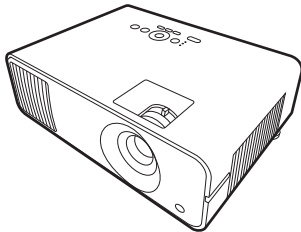

Projector

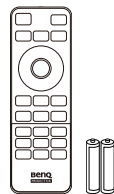

Remote control with batteries

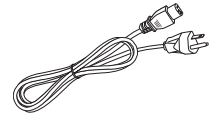

Power cord



Quick start guide



Warranty card*



Regulatory statements



- The supplied accessories will be suitable for your region, and may differ from those illustrated.
- *The warranty card is only supplied in some specific regions. Please consult your dealer for detailed information.

Optional accessories

- Wireless Dongle (EZC5201BS)

Replacing the remote control batteries

1. Press and open the battery cover, as illustrated.
2. Remove the old batteries (if applicable) and install two AAA batteries. Make sure that the positive and negative ends are positioned correctly, as illustrated.
3. Replace the battery cover until it clicks into place.

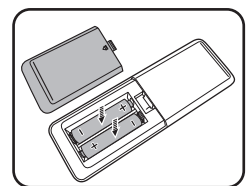
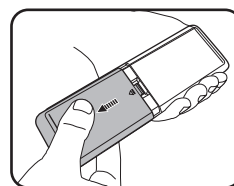

- Avoid leaving the remote control and batteries in an excessive heat or humid environment like the kitchen, bathroom, sauna, sunroom or in a closed car.
- Replace only with the same or equivalent type recommended by the battery manufacturer.
- Dispose of the used batteries according to the manufacturer's instructions and local environment regulations for your region.
- Never throw the batteries into a fire. There may be danger of an explosion.
- If the batteries are dead or if you will not be using the remote control for an extended period of time, remove the batteries to avoid damage to the remote control from possible battery leakage.

Projector exterior view

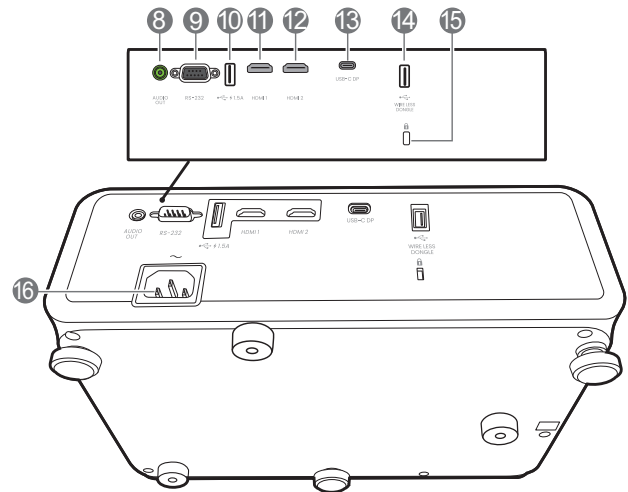
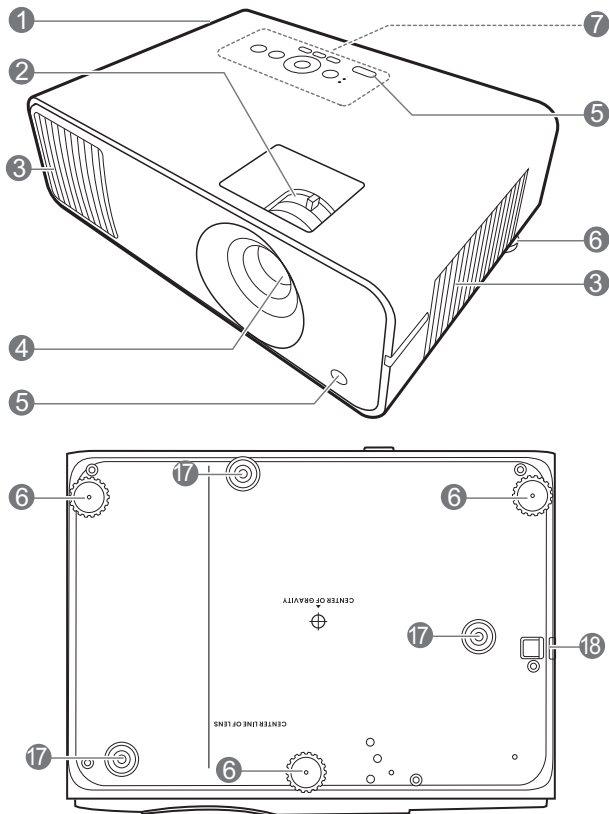

1. Vent (air exhaust)
2. Focus ring and Zoom ring
3. Vent (air inlet)
4. Projection lens
5. IR remote sensor
6. Adjuster feet
7. External control panel
(See [Controls and functions on page 10.](#))

8. Audio output jack
9. RS-232 control port
10. USB Type A port with power charging
11. HDMI 1 input port
12. HDMI 2 input port
13. USB Type C port
14. USB Type A port (for Wireless dongle)
15. Kensington anti-theft lock slot
16. AC power jack
17. Wall mount holes
18. Security bar

Controls and functions

Projector & Remote control



All the key presses described in this document are available on the remote control or projector.

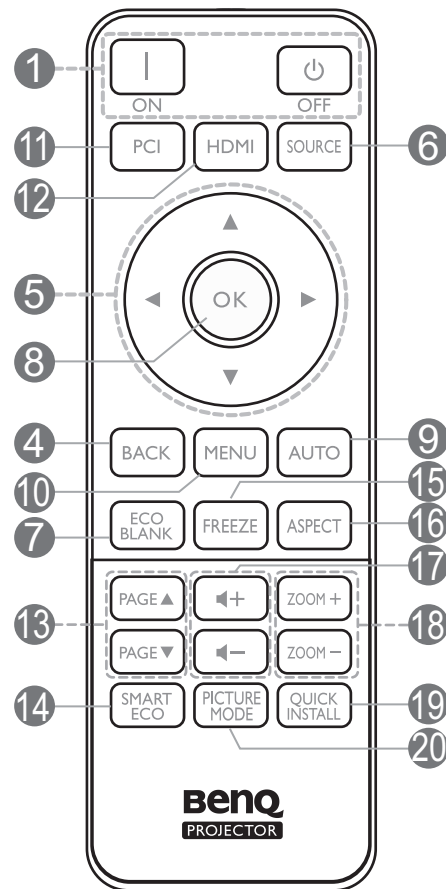
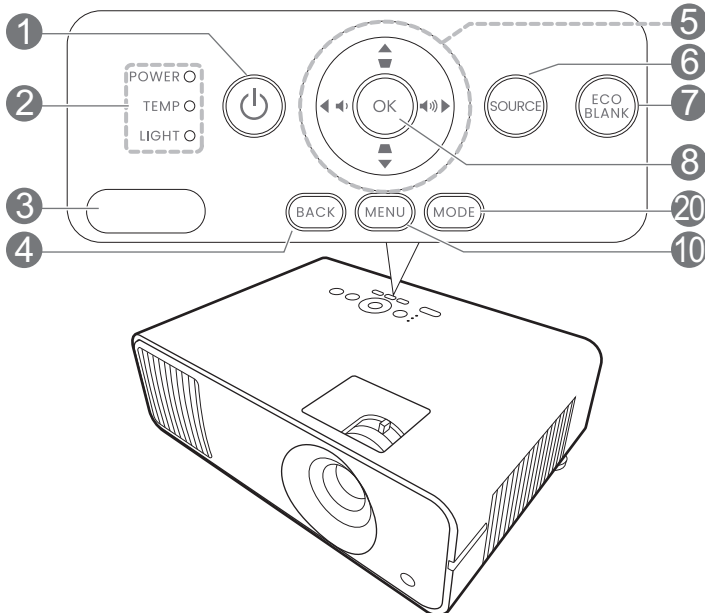

1. POWER

Toggles the projector between standby mode and on.

ON / Off

Toggles the projector between standby mode and on.

2. **POWER indicator light/TEMPerature warning light/LIGHT indicator light** (See [Indicators on page 48.](#))

3. IR remote sensor

4. **BACK**

Goes back to previous OSD menu, exits and saves menu settings.

5. Arrow keys (▲, ▼, ◀, ▶)

When the On-Screen Display (OSD) menu is activated, these keys are used as directional arrows to select the desired menu items and to make adjustments.

Keystone keys (▲, ▼)

Displays the keystone correction page.

Volume keys (🔊 / 🔊)

Decreases or increase the projector volume.

6. SOURCE

Displays the source selection bar.

7. ECO BLANK

Used to hide the screen picture.



Do not block the projection lens from projecting as this could cause the blocking object to become heated and deformed or even cause a fire.

8. OK

Confirms the selected On-Screen Display (OSD) menu item.

9. AUTO

No function.

10. MENU

Turns on the On-Screen Display (OSD) menu.

11. Source selection button: PC 1

No function.

12. Source selection button: HDMI

Selects **HDMI 1** input source for display.

13. PAGE▲/PAGE▼

Operate your display software program (on a connected PC) which responds to page up/down commands (like Microsoft PowerPoint).



This function is only available when the **Page Up/Down** menu is enabled. See [Page Up/Down on page 43](#).

14. SMART ECO

Displays the **Light Mode** menu for selecting a suitable light source operating mode.

15. FREEZE

Freezes the projected image.

16. ASPECT

Selects the display aspect ratio.

17. Volume keys ◀- / ▶+

Decreases or increase the projector volume.

18. ZOOM+/ZOOM-

Magnifies or reduces the projected picture size.

19. QUICK INSTALL

Quickly selects several functions to adjust the projected image and displays the test pattern.

20. PICTURE MODE/MODE

Displays the **Picture Mode** menu for selecting a picture mode.

Remote control effective range

The remote control must be held at an angle within 30 degrees perpendicular to the projector's IR remote control sensor(s) to function correctly. The distance between the remote control and the sensor(s) should not exceed 8 meters (~ 26 feet).

Make sure that there are no obstacles between the remote control and the IR sensor(s) on the projector that might obstruct the infra-red beam.

- Operating the projector from the front

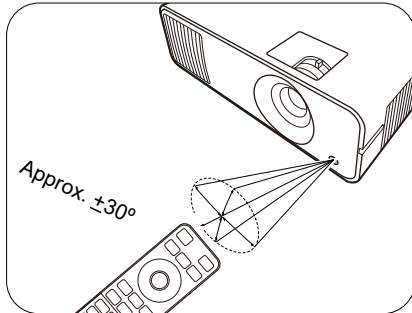

- Operating the projector from the top

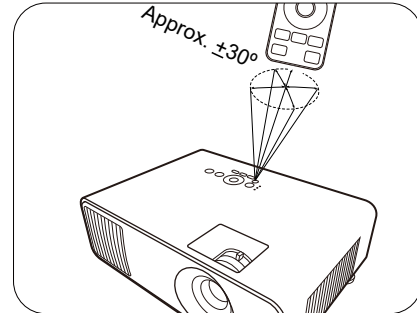

Positioning your projector

Choosing a location

Before choosing an installation location for your projector, take the following factors into consideration:

- Size and position of your screen
- Electrical outlet location
- Location and distance between the projector and the rest of your equipment

You can install your projector in the following ways.

1. Front

Select this location with the projector placed on the table in front of the screen. This is the most common way to position the projector for quick setup and portability.

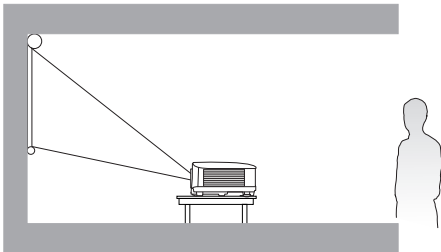

2. Rear

Select this location with the projector placed on the table behind the screen. Note that a special rear projection screen is required.

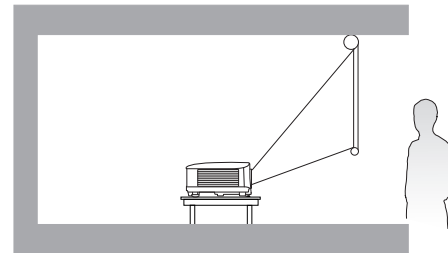

3. Front Ceiling

Select this location with the projector suspended upside-down in front of the screen. Purchase the BenQ Projector Ceiling/Wall Mount Kit from your dealer to mount your projector.

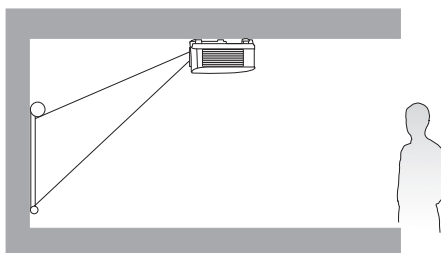

4. Rear Ceiling

Select this location with the projector suspended upside-down from behind the screen. Note that a special rear projection screen and the BenQ Projector Ceiling/Wall Mount Kit are required for this installation location.

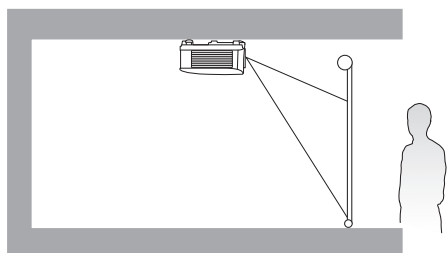

After turning on the projector, go to **Advanced Menu - Installation > Projector Position** and press ◀/▶ to select a setting.

You can also use **QUICK INSTALL** on the remote control to access this menu.

Obtaining a preferred projected image size

The distance from the projector lens to the screen, the zoom setting (if available), and the video format each factors in the projected image size.

Projection dimensions

LW650

- The screen aspect ratio is 16:10 and the projected picture is in a 16:10 aspect ratio

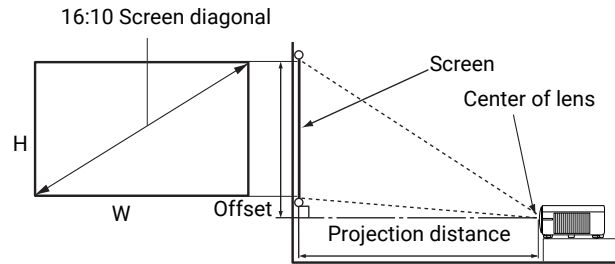

Screen size				Projection distance (mm)			Offset (mm)
Diagonal		H (mm)	W (mm)	Min distance (with max zoom)	Average	Max distance (with min zoom)	
Inch	mm						
30	762	404	646	782	898	1014	10
40	1016	538	862	1042	1198	1353	13
50	1270	673	1077	1303	1497	1691	17
60	1524	808	1292	1564	1796	2029	20
70	1778	942	1508	1824	2096	2367	24
80	2032	1077	1723	2085	2395	2705	27
90	2286	1212	1939	2346	2695	3043	30
100	2540	1346	2154	2606	2994	3382	34
110	2794	1481	2369	2867	3293	3720	37
115	2921	1548	2477	2997	3443	3889	39
120	3048	1615	2585	3127	3593	4058	40
130	3302	1750	2800	3388	3892	4396	44
140	3556	1885	3015	3649	4192	4734	47
150	3810	2019	3231	3909	4491	5072	50
160	4064	2154	3446	4170	4790	5411	54
170	4318	2289	3662	4431	5090	5749	57
180	4572	2423	3877	4691	5389	6087	61
190	4826	2558	4092	4952	5688	6425	64
200	5080	2692	4308	5212	5988	6763	67
210	5334	2827	4523	5473	6287	7101	71
220	5588	2962	4739	5734	6587	7440	74
230	5842	3096	4954	5994	6886	7778	77
240	6096	3231	5169	6255	7185	8116	81
250	6350	3365	5385	6516	7485	8454	84
260	6604	3500	5600	6776	7784	8792	88
270	6858	3635	5816	7037	8084	9130	91
280	7112	3769	6031	7297	8383	9469	94
290	7366	3904	6246	7558	8682	9807	98
300	7620	4039	6462	7819	8982	10145	101

For example, if you are using a 100-inch screen, the recommended projection distance is 2994 mm.

If your measured projection distance is 2000 mm, the closest match in the "Projection distance (mm)" column is 2096 mm. Looking across this row shows that a 70" (about 1.8 m) screen is required.

LH650

- The screen aspect ratio is 16:9 and the projected picture is in a 16:9 aspect ratio

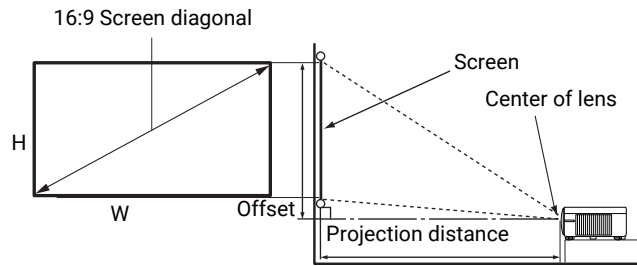

Screen size				Projection distance (mm)			Offset (mm)
Diagonal		H (mm)	W (mm)	Min distance (with max zoom)	Average	Max distance (with min zoom)	
Inch	mm						
30	762	374	664	764	880	996	21
40	1016	498	886	1018	1173	1328	27
50	1270	623	1107	1273	1467	1660	34
60	1524	747	1328	1528	1760	1992	41
70	1778	872	1550	1782	2053	2324	48
80	2032	996	1771	2037	2347	2657	55
90	2286	1121	1992	2291	2640	2989	62
100	2540	1245	2214	2546	2933	3321	68
110	2794	1370	2435	2800	3227	3653	75
115	2921	1432	2546	2928	3373	3819	79
120	3048	1494	2657	3055	3520	3985	82
130	3302	1619	2878	3310	3813	4317	89
140	3556	1743	3099	3564	4107	4649	96
150	3810	1868	3321	3819	4400	4981	103
160	4064	1992	3542	4073	4693	5313	110
170	4318	2117	3763	4328	4987	5645	116
180	4572	2241	3985	4583	5280	5977	123
190	4826	2366	4206	4837	5573	6309	130
200	5080	2491	4428	5092	5867	6641	137
210	5334	2615	4649	5346	6160	6973	144
220	5588	2740	4870	5601	6453	7306	151
230	5842	2864	5092	5856	6747	7638	158
240	6096	2989	5313	6110	7040	7970	164
250	6350	3113	5535	6365	7333	8302	171
260	6604	3238	5756	6619	7627	8634	178
270	6858	3362	5977	6874	7920	8966	185
280	7112	3487	6199	7128	8213	9298	192
290	7366	3611	6420	7383	8507	9630	199
300	7620	3736	6641	7638	8800	9962	205

For example, if you are using a 100-inch screen, the recommended projection distance is 2933 mm.

If your measured projection distance is 2000 mm, the closest match in the "[Projection distance \(mm\)](#)" column is 2053 mm. Looking across this row shows that a 70" (about 1.8 m) screen is required.



To optimize your projection quality, we suggest doing the projection by referring to the values listed in the non-gray rows.



The values in the gray cells are for reference only.



All measurements are approximate and may vary from the actual sizes.

BenQ recommends that if you intend to permanently install the projector, you should physically test the projection size and distance using the actual projector in situ before you permanently install it, so as to make allowance for this projector's optical characteristics. This will help you determine the exact mounting position so that it best suits your installation location.

Mounting the projector

If you intend to mount your projector, we strongly recommend that you use a proper fitting BenQ projector mounting kit and that you ensure it is securely and safely installed.

If you use a non-BenQ brand projector mounting kit, there is a safety risk that the projector may fall down due to an improper attachment through the use of the wrong gauge or length screws.

Before mounting the projector

- Purchase a BenQ projector mounting kit from the place you purchased your BenQ projector.
- BenQ recommends that you also purchase a separate Kensington lock compatible security cable and attach it securely to both the Kensington lock slot on the projector and the base of the mounting bracket. This will perform the secondary role of restraining the projector should its attachment to the mounting bracket become loose.
- Ask your dealer to install the projector for you. Installing the projector on your own may cause it to fall and result in injury.
- Take necessary procedures to prevent the projector from falling off such as during an earthquake.
- The warranty doesn't cover any product damage caused by mounting the projector with a non-BenQ brand projector mounting kit.
- Consider the surrounding temperature where the projector is ceiling/wall mounted. If a heater is used, the temperature around the ceiling/wall may be higher than expected.
- Read the user manual for the mounting kit about the range of torque. Tightening with torque exceeding the recommended range may cause damage to the projector and subsequently falling off.
- Make sure the power outlet is at an accessible height so that you can easily shut down the projector.

Ceiling/Wall mount installation diagram

Ceiling/Wall mount screw: M4
(Max L = 25 mm; Min L = 20 mm)

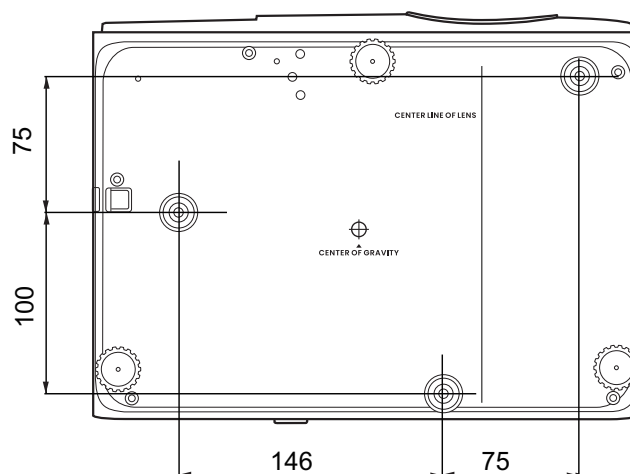

Unit: mm

Adjusting the projected image

Adjusting the projection angle

If the projector is not placed on a flat surface or the screen and the projector are not perpendicular to each other, the projected image becomes trapezoidal. You can screw the adjuster feet to fine-tune the horizontal angle.

To retract the feet, screw the adjuster feet in a reverse direction.

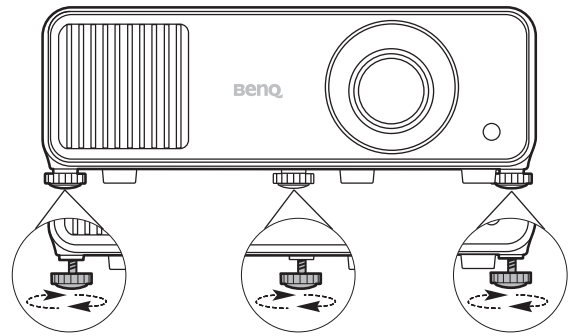

Do not look into the lens while the light source is on. The strong light from the light source may cause damage to your eyes.

Fine-tuning the image size and clarity

Adjust the projected image to the size that you need using the zoom ring. Sharpen the image by rotating the focus ring.

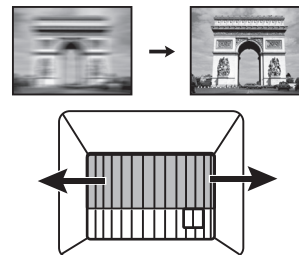
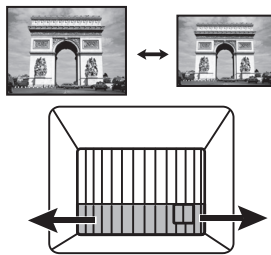

Correcting keystone

Keystoning refers to the situation where the projected image becomes a trapezoid due to angled projection.

To correct this, besides adjusting the height of the projector, if you want the projector to automatically correct image keystone, be sure the **Auto Vertical Keystone** function in the **Advanced Menu - Installation** menu is **On**.

Or you will need to manually correct it following these steps.

1. Do one of the following steps to display the keystone correction page.
 - Press **▲** / **▼** on the projector or remote control.
 - Press **QUICK INSTALL** on the remote control. Press **▼** to highlight **2D Keystone** and press **OK**.
 - Go to **Advanced Menu - Installation > 2D Keystone** and press **OK**.

- After the **2D Keystone** correction page displays. To correct keystone at the top of the image, use ▼. To correct keystone at the bottom of the image, use ▲. To correct keystone at the right side of the image, use ◀. To correct keystone at the left side of the image, use ▶.

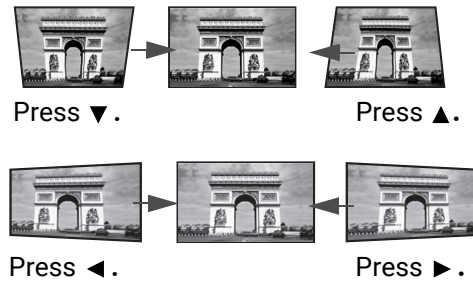

Adjusting Corner Fit

You can manually adjust four corners of the image by setting the horizontal and vertical values.

- Do one of the following steps to display the keystone correction page.
 - Press **QUICK INSTALL** on the remote control. Press ▼ to highlight **Corner Fit** and press **OK**.
 - Go to **Advanced** menu - **Installation** > **Corner Fit** and press **OK**.
- Press ▲/▼/◀/▶ to select one corner and press **OK**.
- Press ▲/▼ to adjust vertical values.
- Press ◀/▶ to adjust horizontal values.

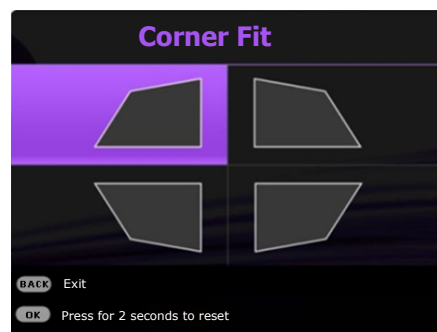

Connection

When connecting a signal source to the projector, be sure to:

1. Turn all equipment off before making any connections.
2. Use the correct signal cables for each source.
3. Ensure the cables are firmly inserted.

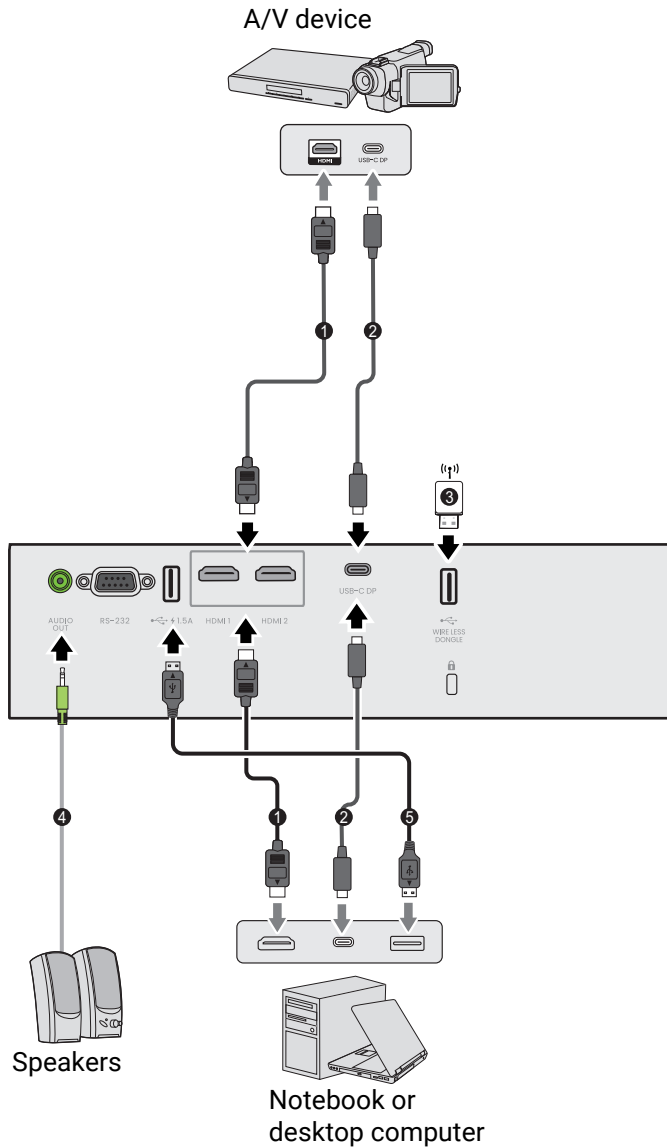

1	HDMI cable
2	USB Type-C cable
3	Wireless dongle
4	Audio cable
5	USB cable



- In the connections above, some cables may not be included with the projector (see [Shipping contents on page 8](#)). They are commercially available from electronics stores.
- The connection illustrations are for reference only. The rear connecting jacks available on the projector vary with each projector model.
- Many notebooks do not turn on their external video ports when connected to a projector. Usually a key combo like FN + function key with a monitor symbol turns the external display on/off. Press FN and the labeled function key simultaneously. Refer to your notebook's documentation to find your notebook's key combination.
- If the selected video image is not displayed after the projector is turned on and the correct video source has been selected, check that the video source device is turned on and operating correctly. Also check that the signal cables have been connected correctly.

Connecting audio

The projector has built-in mono speaker(s) which are designed to provide basic audio functionality accompanying data presentations for business purposes only. They are not designed for, nor intended for stereo audio reproduction use as might be expected in home theater or home cinema applications. Any stereo audio input (if provided), is mixed into a common mono audio output through the projector speaker(s).

The built-in speaker(s) will be muted when the **AUDIO OUT** jack is connected.



- The projector is only capable of playing mixed mono audio, even if a stereo audio input is connected.
- If the selected video image is not displayed after the projector is turned on and the correct video source has been selected, check that the video source device is turned on and operating correctly. Also check that the signal cables have been connected correctly.

Connecting the Wireless Dongle

The projector has equipped with a **WIRELESS DONGLE** port for the Wireless Dongle (EZC5201BS) which supports wireless projection between the projector and the following systems: iOS, macOS, Android, Windows.

After inserting the WiFi dongle into the **WIRELESS DONGLE** port, select **Wireless Display** from the source selection bar. You can follow the on-screen instructions to enable wireless projection.

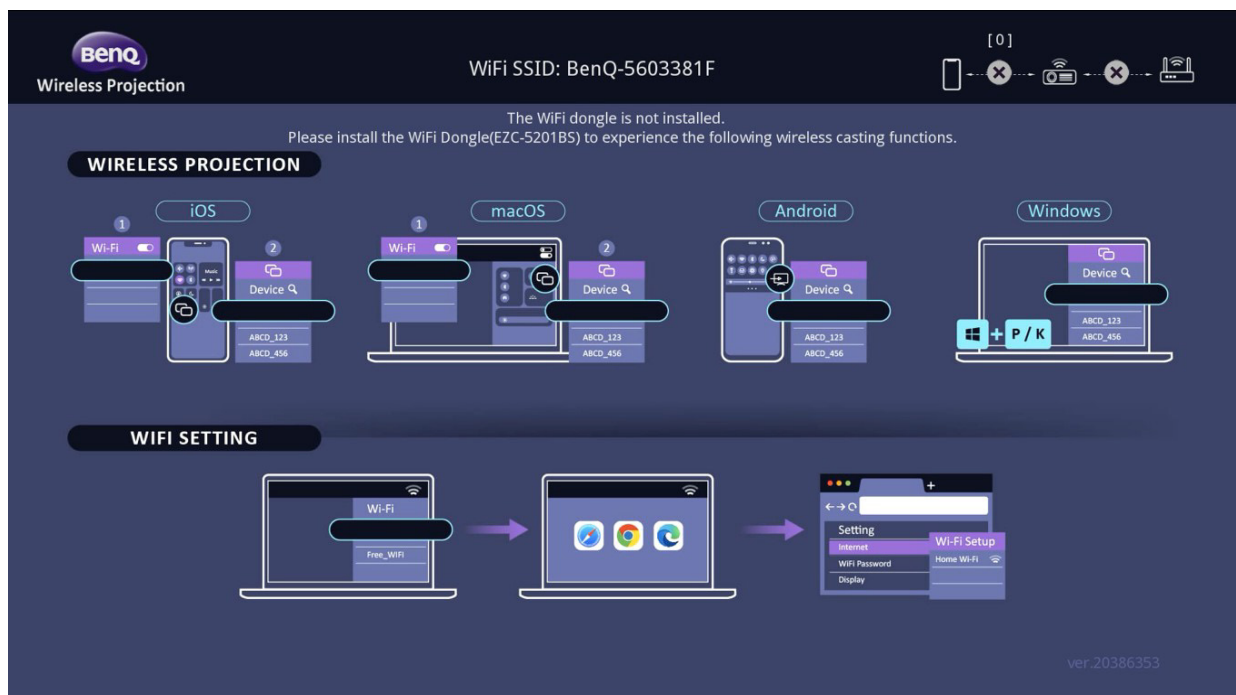

Performing wireless projection

For different devices, follow the steps below.

- For iOS/macOS devices

1. Select the WiFi network that the projector joined in the WiFi settings on your device.
2. After opening control center, press screen mirroring and choose the projector (BenQ_xxxxxxx) to start projection.

- For Android devices

After opening the Quick settings panel, press the Screen Mirroring icon and choose the projector (BenQ_xxxxxxx).

- For Windows OS devices



Press the Windows + P / K and choose the projector (BenQ_xxxxxxx).

Connecting the projector to the Internet

1. Select the WiFi SSID (BenQ_xxxxxxx) of the projector in the WiFi settings on your device.
2. Enter the password from the projected image.
3. Open your web browser and go to the address of the projector (192.168.203.1).
4. Select a WiFi network that you want to join.
5. Enter the password if asked.

Operation

Starting up the projector

1. Plug the power cord. Turn on the power outlet switch (where fitted). The power indicator on the projector lights orange after power has been applied.
2. Press  on the projector or  on the remote control to start the projector. The power indicator flashes green and stays green when the projector is on.

The start up procedure takes about 10 seconds. In the later stage of start up, a startup logo is projected.

(If necessary) Rotate the focus ring to adjust the image clearness.

3. If the projector is activated for the first time, select your OSD language following the on-screen instructions.
4. If you are prompted for a password, press the arrow keys to enter a 6-digit password. See [Utilizing the password function on page 25](#).
5. Switch all of the connected equipment on.

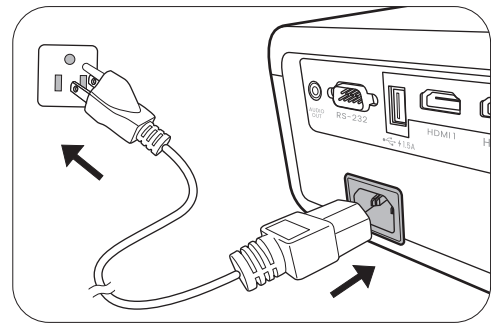

6. The projector will search for input signals. The current input signal being scanned appears. If the projector does not detect a valid signal, the message “No Signal” will continue displaying until an input signal is found.



You can also press **SOURCE** to select your desired input signal. See [Switching input signal on page 26](#).



- Please use the original accessories (e.g. power cord) to avoid possible dangers such as electric shock and fire.
- If the projector is still hot from previous activity, it will run the cooling fan for approximately 90 seconds before energizing the light source.



- The Setup Wizard screenshots are for reference only and may differ from the actual design.
- If the frequency/resolution of the input signal exceeds the projector's operating range, you will see the message “Out of Range” displayed on the background screen. Please change to an input signal which is compatible with the projector's resolution or set the input signal to a lower setting. See [Timing chart on page 52](#).
- If no signal is detected for 3 minutes, the projector automatically enters saving mode.

Using the menus

The projector is equipped with 2 types of On-Screen Display (OSD) menus for making various adjustments and settings.

- **Basic** OSD menu: provides primary menu functions. (See [Basic Menu on page 28](#))
- **Advanced** OSD menu: provides full menu functions. (See [Advanced Menu on page 29](#))

To access the OSD menu, press **MENU** on the projector or remote control.

- Use the arrow keys ($\blacktriangle/\blacktriangledown/\blacktriangleleft/\blacktriangleright$) on the projector or remote control to move through the menu items.
- Use **OK** on the projector or remote control to confirm the selected menu item.

The first time you use the projector (after finishing the initial setup), press **MENU**, and the **Advanced** OSD menu will be displayed.



The OSD screenshots below are for reference only, and may differ from the actual design.

Below is the overview of the **Basic** OSD menu.

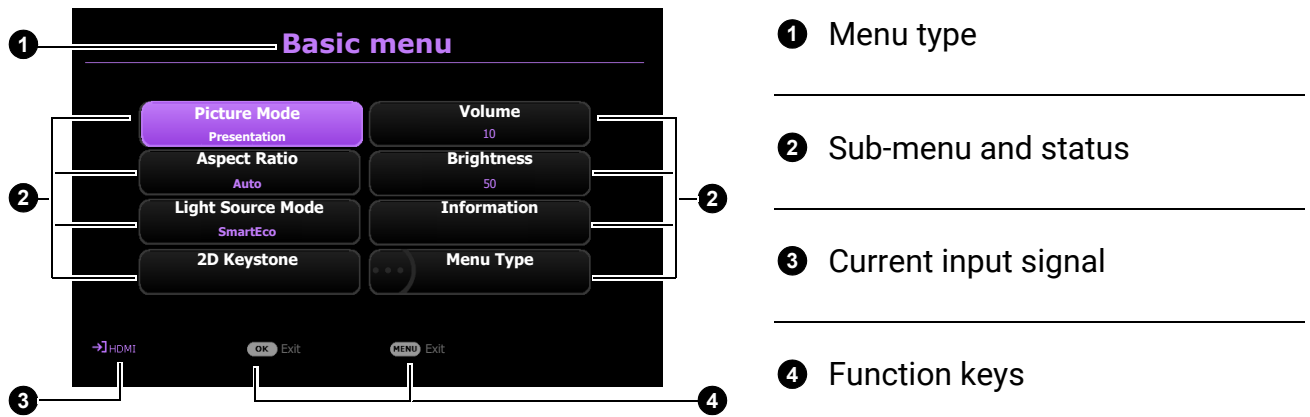

If you intend to switch from the **Basic** OSD menu to the **Advanced** OSD menu, follow the instructions below:

1. Go to **Menu Type** and press **OK**.
2. Press $\blacktriangle/\blacktriangledown$ to select **Advanced** and press **OK**. Your projector will switch to **Advanced** OSD menu.

Below is the overview of the **Advanced** OSD menu.

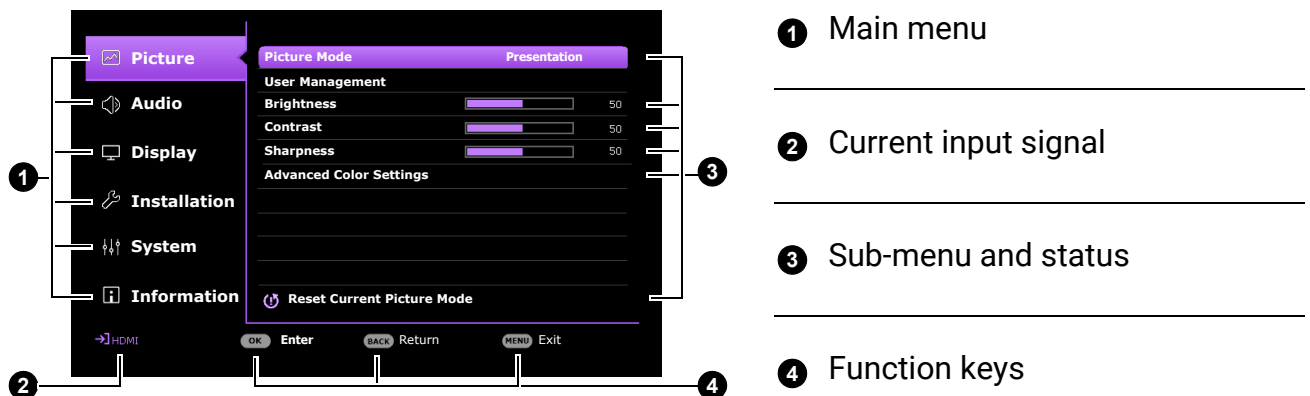

Likewise, when you wish to switch from the **Advanced** OSD menu to the **Basic** OSD menu, follow the instructions below:

1. Go to **System > Menu Settings > Menu Type** and press **OK**.
2. Press **▲/▼** to select **Basic**. Your projector will switch to the **Basic** OSD menu.

Securing the projector

Using a security cable lock

The projector has to be installed in a safe place to prevent theft. Otherwise, purchase a lock, such as the Kensington lock, to secure the projector. You can locate a Kensington lock slot on the rear side of the projector. See item 15 on [page 9](#).

A Kensington security cable lock is usually a combination of key(s) and the lock. Refer to the lock's documentation for finding out how to use it.

Utilizing the password function

Setting a password

1. Go to **Advanced** menu - **System > Security Settings**. Press **OK**. The **Security Settings** page appears.
2. Highlight **Change Password** and press **OK**.
3. The four arrow keys (**▲**, **▶**, **▼**, **◀**) respectively represent 4 digits (1, 2, 3, 4). According to the password you desire to set, press the arrow keys to enter six digits for the password.
4. Confirm the new password by re-entering the new password.
5. To activate the **Power On Lock** function, press **▲/▼** to highlight **Power On Lock** and press **◀/▶** to select **On**. Input the password again.

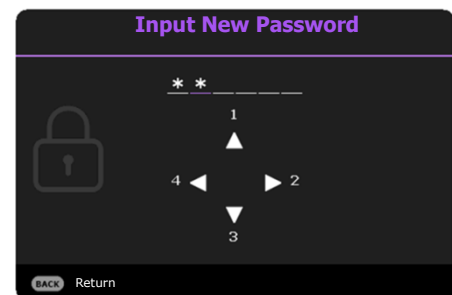

- The digits being input will display as asterisks on-screen. Make a note of your selected password and keep it in a safe place in advance or right after the password is entered so that it is available to you should you ever forget it.
- Once a password has been set and the power on lock is activated, the projector cannot be used unless the correct password is entered every time the projector is started.

If you forget the password

If you enter the wrong password, the password error message will appear, and the **Input Password** message follows. If you absolutely do not remember the password, you can use the password recall procedure. See [Entering the password recall procedure on page 26](#).

If you enter an incorrect password 5 times in succession, the projector will automatically shut down in a short time.

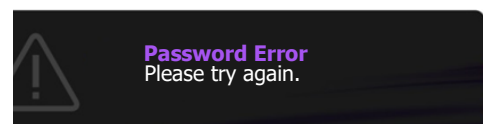

Entering the password recall procedure

1. Press and hold **OK** for 3 seconds. The projector will display a coded number on the screen.
2. Write down the number and turn off your projector.
3. Seek help from the local BenQ service center to decode the number. You may be required to provide proof of purchase documentation to verify that you are an authorized user of the projector.

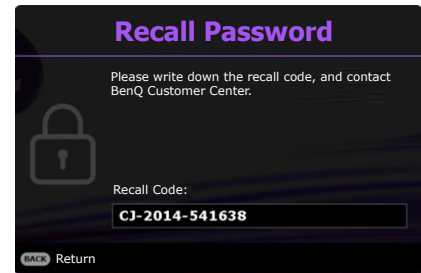

Changing the password

1. Go to **Advanced** menu - **System** > **Security Settings** > **Password**. Press **OK**. The **Password** page appears.
2. Highlight **Change Password** and press **OK**.
3. Enter the old password.
 - If the password is correct, another message **"Input New Password"** appears.
 - If the password is incorrect, the password error message will appear, and the message **"Input Password"** appears for your retry. You can press **BACK** to cancel the change or try another password.
4. Enter a new password.
5. Confirm the new password by re-entering the new password.

Disabling the password function

To disable password protection, go to **Advanced** menu - **System** > **Security Settings** > **Password** > **Power On Lock** and press **OK** and **◀/▶** to select **Off**. The message **Input Password** appears. Enter the current password.

- If the password is correct, the OSD menu will disappear. You will not have to enter the password next time turning on the projector.
- If the password is incorrect, the password error message will appear, and the message **Input Current Password** appears for your retry. You can press **BACK** to cancel the change or try another password.



Though the password function is disabled, you need to keep the old password in hand should you ever need to re-activate the password function by entering the old password.

Switching input signal

The projector can be connected to multiple devices at the same time. However, it can only display one full screen at a time. When starting up, the projector automatically searches for the available signals.

Be sure the **Advanced** menu - **Display** > **Auto Source Search** menu is **On** if you want the projector to automatically search for the signals.

To select the source:

1. Press **SOURCE**. A source selection bar appears.
2. Press **▲/▼** until your desired signal is selected and press **OK**.

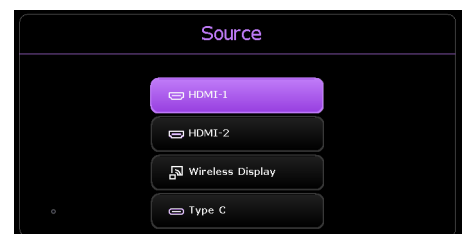





Once detected, the selected source information will appear at the corner of the screen for seconds. If there is multiple equipment connected to the projector, repeat steps 1-2 to search for another signal.



- The brightness level of the projected image will change accordingly when you switch between different input signals.
- For best display picture results, you should select and use an input signal which outputs at the projector's native resolution. Any other resolutions will be scaled by the projector depending upon the "aspect ratio" setting, which may cause some image distortion or loss of picture clarity. See [Aspect Ratio on page 36](#).

Shutting down the projector

1. Press  on the projector or  on the remote control and a confirmation message will appear prompting you. If you don't respond in a few seconds, the message will disappear.
2. Press  or  a second time. The power indicator flashes orange, the projection light source shuts down, and the fans will continue to run for approximately 2 seconds to cool down the projector.
3. Once the cooling process finishes, the power indicator becomes a steady orange and fans stop. Disconnect the power cord from the power outlet.

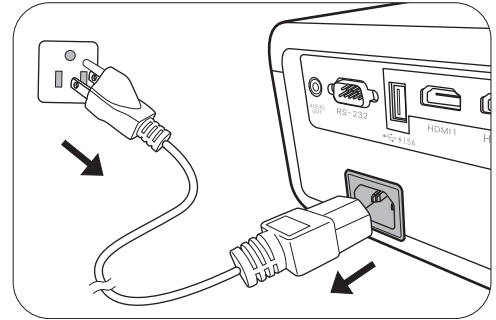

- To protect the light source, the projector will not respond to any commands during the cooling process.

Menu operation

Please note that the on-screen display (OSD) menus vary according to the signal type selected and the projector model you are using.

The menu items are available when the projector detects at least one valid signal. If there is no equipment connected to the projector or no signal detected, limited menu items are accessible.

Menu System

Basic Menu

Menu (Ref. Page)	Options
Picture Mode (30)	Bright/Presentation/Spreadsheet/Video Conference/Infographic/(3D)/(HDR10)/(HLG)/User1/User2
Aspect Ratio (36)	Auto/4:3/16:9/16:10
Light Source Mode (47)	Normal
	ECO
	SmartEco
	Custom
2D Keystone (18)	H: -30~0~30
	V: -30~0~30
Volume (35)	0 – 20
Brightness (31)	0–100
Information (45)	Native Resolution
	Detected Resolution
	Source
	Picture Mode
	Light Source Mode
	3D Format
	Color System
	Dynamic Range
	Light Source Usage Time
	Firmware Version
Service Code	
Menu Type (43)	Basic/Advanced

Advanced Menu

1. Main menu: **Picture**

Structure

Menu		Options	
Picture Mode		Bright/Presentation/Spreadsheet/Video Conference/Infographic/(3D)/(HDR10)/(HLG)/User1/User2	
User Management	Load Settings From	Presentation/Spreadsheet/Video Conference/Infographic	
	Rename User Mode		
Brightness		0–100	
Contrast		0–100	
Sharpness		0–31	
Gamma Selection		1.8/2.0/2.1/2.2/2.3/2.4/2.5/2.6/BenQ	
Color Temperature		Normal/Cool/Native/Warm	
Advanced Color Settings	Color Temperature Tuning	R Gain/G Gain/B Gain	0–200
		R Offset/G Offset/B Offset	0–511
		R/G/B/C/M/Y	Hue/Saturation/Gain
Color Management	W (White Balance)	R Gain/G Gain/B Gain	
	Reset	Reset/Cancel	
Brilliant Color		0–10	
Light Source Mode		Normal/ECO/SmartEco/Custom	
Custom Brightness		50%–100%	
HDR Brightness		-2/-1/0/1/2	
Noise Reduction		0–31	
Reset Current Picture Mode		Reset/Cancel	

Function descriptions

Menu	Descriptions
Picture Mode	<p>The projector is preset with several predefined picture modes so that you can choose one to suit your operating environment and input signal picture type.</p> <ul style="list-style-type: none">• Bright: Maximizes the brightness of the projected image. This mode is suitable for environments where extra-high brightness is required.• Presentation: Is designed for presentations. The brightness is emphasized in this mode to match PC and notebook coloring.• Spreadsheet: Designs for users who widely use excel and table to discuss financial numbers or quality numbers in meetings.• Video Conference: Design for video conference scenarios which showcases detail skin color of remote meeting attendees.• Infographic: Is perfect for presentations with the mixture of text and graphics due to its high color brightness and better color gradation to see the details clearly.• 3D: Is appropriate for playing 3D images and 3D video clips. This mode is only available when 3D function is enabled and 3D content is detected.• HDR10: Delivers High Dynamic Range effects with higher contrasts of brightness and colors for HDR Blu-ray movies. Picture Mode will be switched to HDR10 automatically while detecting metadata or EOTF info from HDR contents.• HLG Delivers High Dynamic Range effects with higher contrasts of brightness and colors. Picture Mode will be switched to HLG automatically while detecting metadata or EOTF info from HLG streaming contents.• User1/User2: Recalls the settings customized based on the current available picture modes. See User Management on page 31.

There is one user-definable mode if the current available picture modes are not suitable for your need. You can use one of the picture modes (except the **User1/User2** mode) as a starting point and customize the settings.

• **Load Settings From**

1. Go to **Picture > Picture Mode**.
2. Press **◀/▶** to select **User1** or **User2**.
3. Press **▼** to highlight **User Management**, and press **OK**. The **User Management** page is displayed.
4. Select **Load Settings From** and press **OK**.
5. Press **▼/▲** to select a picture mode that is closest to your need.
6. Press **OK** and **BACK** to return to the **Picture** menu.
7. Press **▼** to select the sub-menu items you want to change and adjust the values with **◀/▶**. The adjustments define the selected user mode.

• **Rename User Mode**

Select to rename the customized picture mode (**User1/User2**). The new name can be up to 9 characters including English letters (A-Z, a-z), digits (0-9), and space (_).

1. Go to **Picture > Picture Mode**.
2. Press **◀/▶** to select **User1** or **User2**.
3. Press **▼** to highlight **User Management**, and press **OK**. The **User Management** page is displayed.
4. Press **▼** to highlight **Rename User Mode** and press **OK**. The **Rename User Mode** page is displayed.
5. Use **▲/▶ /▼/◀**, and **OK** to set desired characters.
6. When done, press **BACK, Commit** to save the changes and exit.

User Management

Brightness

The higher the value, the brighter the image. Adjust this control so the black areas of the image appear just as black and that detail in the dark areas is visible.

Contrast

The higher the value, the greater the contrast. Use this to set the peak white level after you have previously adjusted the Brightness setting to suit your selected input and viewing environment.

Sharpness

The higher the value, the sharper the picture becomes.

• Gamma Selection

Gamma refers to the relationship between input source and picture brightness.

- **1.8/2.0/2.1**: Select these values according to your preference.
- **2.2/2.3**: Increases the average brightness of the picture. Best for a lit environment, meeting room or family room.
- **2.4/2.5**: Best for viewing movies in a dark environment.
- **2.6**: Best for viewing movies which are mostly composed of dark scenes.
- **BenQ**: Finely-tuned gamma to optimize details and increase contrast.

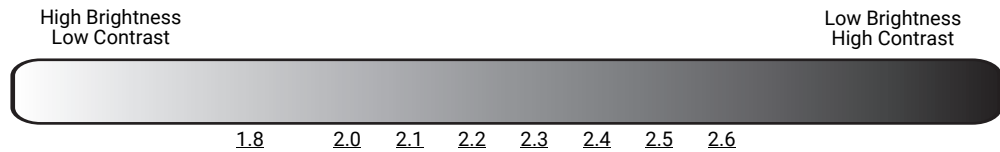

Advanced Color Settings

• Color Temperature Tuning

There are several preset color temperature settings available. The available settings may vary according to the signal type selected.

- **Normal**: Maintains normal colorings for white.
- **Cool**: Makes images appear bluish white.
- **Native**: With the light source's original color temperature and higher brightness. This setting is suitable for environments where high brightness is required, such as projecting pictures in well lit rooms.
- **Warm**: Makes images appear reddish white.

You can also set a preferred color temperature by adjusting the following options.

- **R Gain/G Gain/B Gain**: Adjusts the contrast levels of Red, Green, and Blue.
 - **R Offset/G Offset/B Offset**: Adjusts the brightness levels of Red, Green, and Blue.
-

• Color Management

The Color Management provides six sets (RGBCMY) of colors to be adjusted. When you select each color, you can independently adjust its range and saturation according to your preference.

To make adjustments, press the ▲/▼ arrows to highlight an independent color from among Red (R), Green (G), Blue (B), Cyan (C), Magenta (M), Yellow (Y) or White (W). The following menu items are displayed for your choice.

- **Hue:** Increase in the range will include colors consisted of more proportions of its two adjacent colors. Please refer to the illustration for how the colors relate to each other.
For example, if you select Red and set its range at 0, only pure red in the projected picture will be selected. Increasing its range will include red close to yellow and red close to magenta.

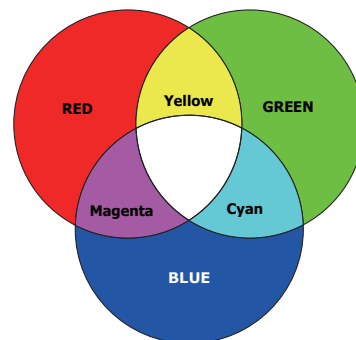

- **Saturation:** Adjusts the values to your preference. Every adjustment made will reflect to the image immediately. For example, if you select Red and set its value at 0, only the saturation of pure red will be affected.
- **Gain:** Adjusts the values to your preference. The contrast level of the primary color you select will be affected. Every adjustment made will reflect to the image immediately.

If you select **White Balance**, you can adjust the contrast levels of Red, Green, Blue, Cyan, Magenta, Yellow and White by selecting **R Gain**, **G Gain**, and **B Gain**.

To return all the settings to the factory default values, highlight **Reset**, and press **OK**.



Saturation is the amount of that color in a video picture. Lower settings produce less saturated colors; a setting of "0" removes that color from the image entirely. If the saturation is too high, that color will be overpowering and unrealistic.

• Brilliant Color

This feature utilizes a new color-processing algorithm and system level enhancements to enable higher brightness while providing truer, more vibrant colors in picture. It enables a greater than 50% brightness increase in mid-tone images, which are common in video and natural scenes, so the projector reproduces images in realistic and true colors. If you prefer images with that quality, select a desired level.

When **0** is selected, the **Color Temperature** function is not available.

• Light Source Mode

Selects a suitable light source power from among the provided modes. See [Extending light source life on page 47](#).

Advanced Color Settings (Continued)

**Advanced Color
Settings
(Continued)**

• **Custom Brightness**

You can adjust the light source brightness. This function is only available when **Light Source Mode** is **Custom**.

• **HDR Brightness**

The projector can automatically adjust the brightness levels of your image according to the input source. You can also manually select a brightness level to display better picture quality. When the value is higher, the image becomes brighter; when the value is lower, the image becomes darker.

• **Noise Reduction**

Reduces electrical image noise caused by different media players.

**Reset Current
Picture Mode**

Returns all of the adjustments you've made for the selected **Picture Mode** (including the preset mode, **User1** and **User2**) to the factory preset values.

1. Press **OK**. The confirmation message is displayed.
2. Use ◀/▶ to select **Reset** and press **OK**. The current picture mode returns to the factory preset settings.



The following settings will still remain: **Picture Mode, Load Settings From**.

2. Main menu: **Audio**

Structure

Menu	Options
Mute	Off/On
Volume	0 – 20
Power On/Off Ring Tone	Off/On
Reset Audio	Reset/Cancel

Function descriptions

Menu	Descriptions
Mute	Select On to temporarily turn off the projector's internal speaker or the volume being output from the audio output jack. To restore the audio, select Off .
Volume	Adjusts the volume level of the projector's internal speaker or the volume being output from the audio output jack. If the Mute function is activated, adjusting Volume will turn off the Mute function.
Power On/Off Ring Tone	Sets the ring tone for the projector On or Off . The Power On/Off Ring Tone can only be adjusted here. Setting the sound mute or adjusting the sound level do not affect the Power On/Off Ring Tone .
Reset Audio	Returns all of the adjustments you've done under the Audio menu to the factory preset values.

3. Main menu: **Display**

Structure

Menu		Options
Aspect Ratio		Auto/4:3/16:9/16:10
Auto Source Search		Off/On
Source Rename		HDMI-1/HDMI-2
3D	3D Mode	Auto/Top Bottom/Frame Sequential/ Frame Packing/Side by Side/Off
	3D Sync Invert	Disable/Invert
	Save 3D Settings	3D Settings 1/3D Settings 2/ 3D Settings 3
	Apply 3D Settings	3D Settings 1/3D Settings 2/ 3D Settings 3
HDMI Settings	HDMI Format	Auto/Limited/Full
	HDMI Equalizer	HDMI-1/HDMI-2 Auto/1/2/3/4/5
	HDMI EDID	HDMI-1/HDMI-2 Enhanced/Standard
Reset Display		Reset/Cancel

Function descriptions

Menu	Descriptions
Aspect Ratio	<p>There are several options to set the image's aspect ratio depending on your input signal source.</p> <ul style="list-style-type: none"> • Auto: Scales an image proportionally to fit the projector's native resolution in its horizontal or vertical width. • 4:3: Scales an image so that it is displayed in the center of the screen with a 4:3 aspect ratio. • 16:9: Scales an image so that it is displayed in the center of the screen with a 16:9 aspect ratio. • 16:10: Scales an image so that it is displayed in the center of the screen with a 16:10 aspect ratio.
Auto Source Search	Allows the projector to automatically search for a signal.
Source Rename	<p>Renames the current input source to your desired name.</p> <p>On the Source Rename page:</p> <ol style="list-style-type: none"> 1. Press OK to display the on-screen keyboard. 2. Press ▲/▼/◀/▶ to select each desired digit/letter, and press OK to confirm each input. 3. Repeat the step above and when done, press BACK and ▼ to highlight Commit. 4. Press OK and the source name changes.

This projector supports playing three-dimensional (3D) content transferred through your 3D-compatible video devices and contents, such as PlayStation consoles (with 3D game discs), 3D Blu-ray players (with 3D Blu-ray discs), and so on. After you have connected the 3D video devices to the projector, wear a pair of 3D glasses and make sure the power is on to view 3D contents.

When watching 3D contents:

- The image may seem misplaced; however, this is not a product malfunction.
- Take appropriate breaks when watching 3D contents.
- Stop watching 3D contents if you feel fatigue or discomfort.
- Keep a distance from the screen of about three times the effective height of the screen.
- Children and people with a history of oversensitivity to light, heart problems, or any other existing medical conditions should be refrained from watching 3D contents.
- The image may seem reddish, greenish, or bluish without wearing 3D glasses. However, you will not notice any color bias when watching 3D contents with 3D glasses.
- The 4K source will not be displayed.

3D

• 3D Mode

The projector can automatically enable 3D mode via the contents when the source type is HDMI and supports 1.4a. If you want the projector to automatically choose an appropriate 3D format when detecting 3D contents, select **Auto**. If the projector cannot recognize the 3D format, choose a 3D mode from among **Top Bottom**, **Frame Sequential**, **Frame Packing** and **Side by Side**.

When **3D Mode** is enabled:

- The brightness level of the projected image decreases.
- The **Picture Mode** cannot be adjusted.
- The **2D Keystone** can only be adjusted within limited degrees.

- **3D Sync Invert**

When your 3D image is distorted, enable this function to switch between the image for the left eye and the right eye for more comfortable 3D viewing experience.

- **Save 3D Settings**

When you have successfully displayed the 3D contents after making the appropriate adjustments, you can enable this function and choose a set of 3D settings to memorize current 3D settings.

- **Apply 3D Settings**

After the 3D settings are saved, you can decide if you would like to apply them by choosing a set of 3D settings that you have saved. Once applied, the projector will automatically play the incoming 3D contents if it matches the 3D settings saved.



Only the set(s) of 3D settings with memorized data is available.

- **HDMI Format**

Selects a suitable RGB color range to correct the color accuracy.

- **Auto:** Automatically selects a suitable color range for the incoming HDMI signal.
- **Limited:** Utilizes the Limited range RGB 16-235.
- **Full:** Utilizes the Full range RGB 0-255.

- **HDMI Equalizer**

Sets a suitable value to maintain the HDMI picture quality in long distance data transmission.

- **HDMI EDID**

Switches between **Enhanced** for HDMI 2.0 EDID and **Standard** for HDMI 1.4 EDID. Selecting **Standard** which supports up to 1080p 60Hz may solve abnormal display issues with some old players.

HDMI Settings

Reset Display

Returns all the settings on the **Display** main menu to the factory default values.

4. Main menu: **Installation**

Structure

Menu		Options	
Projector Position		Front/Front Ceiling/Rear/Rear Ceiling	
2D Keystone		H: -30 – +30 V: -30 – +30	
Auto Vertical Keystone		Off/On	
Test Pattern		On/Off	
High Altitude Mode		On/Off	
Baud Rate		9600/14400/19200/38400/57600/ 115200	
Corner Fit		0~60	
Wall Color		Off/Light Yellow/Pink/Light Green/Blue/ Blackboard	
Image Resizing	Digital Zoom	1.0X – 1.8X/2.0X	
	Digital Shrink & Shift	0.75X~1.0X	
	Blanking	Modes of Adjustment	
		Top	
		Bottom	
		Left	
Right			
		Reset All Blanking Settings	
Image Memory	Save Image Memory	Memory-1/Memory-2/Memory-3/ Memory-4/Memory-5	
	Apply Image Memory		
	Rename		

Function descriptions

Menu	Descriptions
Projector Position	The projector can be installed on a ceiling or behind a screen, or with one or more mirrors. See Choosing a location on page 13 for details.
2D Keystone	See Correcting keystone on page 18 for details.
Auto Vertical Keystone	Automatically corrects the keystone at the top/bottom side of the projected image.

Test Pattern Adjusts the image size and focus and check that the projected image is free from distortion.

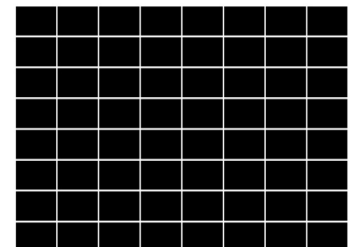

High Altitude Mode	<p>We recommend you use the High Altitude Mode when your environment is between 1501 m–3000 m above sea level, and ambient temperature is between 0°C–30°C.</p> <p>Operation under "High Altitude Mode" may cause a higher decibel operating noise level because of increased fan speed necessary to improve overall system cooling and performance.</p> <p>If you use this projector under other extreme conditions excluding the above, it may display auto shut-down symptoms, which is designed to protect your projector from over-heating. In cases like this, you should switch to High Altitude mode to solve these symptoms. However, this is not to state that this projector can operate under any and all harsh or extreme conditions.</p>
	<p></p> <p>Do not use the High Altitude Mode if your altitude is between 0 m and 1500 m and ambient temperature is between 0°C and 35°C. The projector will be over cooled, if you turn the mode on under such a condition.</p>
Baud Rate	<p>Selects a baud rate that is identical with your computer's so that you can connect the projector using a suitable RS-232 cable. This function is intended for qualified service personnel.</p>
Corner Fit	<p>See Connection on page 20 for details.</p>
Wall Color	<p>Corrects the projected picture's color when the projection surface such as a painted wall which may not be white, the Wall Color feature can help correct the projected picture's colors to prevent possible color difference between the source and projected pictures. There are several precalibrated colors to choose from: Light Yellow, Pink, Light Green, Blue, and Blackboard.</p>

• Digital Zoom

Magnifies or reduces the projected image size.

1. After the adjustment bar displays, press ▲/▼ on the projector or **ZOOM+/ZOOM-** on the remote control repeatedly to reduce or magnify the image to a desired size.
2. Press **OK** to enter panning mode.
3. Press the directional arrows (▲, ▼, ◀, ▶) on the projector or remote control to navigate the picture.



The picture can only be navigated after it is magnified. You can further magnify the picture while searching for details.

• Digital Shrink & Shift

Shrinks and/or shifts the projected image.

1. After the adjustment bar displays, press ◀/▶ repeatedly to shrink or magnify the picture to a desired size.
2. Press **OK** to activate digital shift function.
3. After digital shift function is activated, press the directional arrows (▲, ▼, ◀, ▶) to shift the image.



The picture can only be shifted after it shrank.

• Blanking

Blanks some parts of the projected image.

1. Select the **Modes of Adjustment** first by pressing ◀/▶.
2. Press ▲/▼ to highlight the area you want to adjust and press ◀/▶ to adjust its range.



Enacting the **Reset All Blanking Settings** function will return all items in the **Blanking** menu to the factory preset values. Pressing **OK** clears the values of selected item.

Image Resizing

Image Memory

-
- **Save Image Memory:** Allows you to save and apply several sets of image settings for regularly used circumstances, including the following settings: **Projector Position, Aspect Ratio, Picture Mode, Source, Resolution, Light Source Mode, Digital Shrink & Shift, Blanking**. You can choose one set of memory to save the current settings.
 - **Apply Image Memory:** After the image memories are saved, you can decide if you would like to apply it by choosing a set of memory that you have saved.
 - **Rename:** Renames the image memories.
-



5. Main menu: **System**

Structure

Menu		Options	
Language		English/Français/Deutsch/Italiano/Español/ Русский/繁體中文/简体中文/日本語/한국어/ Svenska / Nederlands/ Türkçe/Čeština/ Português/ไทย/Polski/Magyar/Hrvatski/ Română/Norsk/Dansk/Български/ Suomi/Bhs Ind / Ελληνικά/ العربية/ हिंदी / فارسی / Tiếng Việt	
Background Settings	Background Color	Black/Blue/Purple	
	Splash Screen	BenQ/Black/Blue	
Menu Settings	Menu Type	Basic/Advanced	
	Menu Display Time	5 sec/10 sec/20 sec/30 sec/Always	
	Menu Position	Center/Top-Left/Top-Right/ Bottom-Right/Bottom-Left	
	Reminder Message	Off/On	
Light Source Information	Light Source Usage Time		
	Normal Mode		
	ECO Mode		
	SmartEco Mode		
	Custom Mode		
Standby Settings	Standby Mode	Eco/Normal	
	Audio Pass Through	Off/HDMI-1/HDMI-2	
Operation Settings	LED Indicator	Off/On	
	Power On/Off Settings	Direct Power On	Off/On
		Signal Power On	HDMI-1/HDMI-2
		Auto Power Off	Disable/3 min/10 min/15 min/ 20 min/25 min/30 min
Page Up/Down		Off/On	
Security Settings	Panel Key Lock	Off/On	Yes/No
	Password		Change Password Power On Lock
Factory Default		Reset/Cancel	
Reset System		Reset/Cancel	

Function descriptions

Menu	Descriptions
Language	Sets the language for the On-Screen Display (OSD) menus.
Background Settings	• Background Color
	Sets the background color for the projector.
	• Splash Screen
	Allows you to select which logo screen will be displayed during projector start-up.

<p>Menu Settings</p>	<ul style="list-style-type: none"> • Menu Type Sets the OSD menu type according to your needs. • Menu Display Time Sets the length of time the OSD will remain active after your last key press. • Menu Position Sets the On-Screen Display (OSD) menu position. • Reminder Message Sets the reminder messages on or off.
<p>Light Source Information</p>	<p>This menu page displays the following information:</p> <ul style="list-style-type: none"> • Light Source Usage Time • Light hours used under Normal Mode, ECO Mode, SmartEco Mode, Custom Mode.
<p>Standby Settings</p>	<ul style="list-style-type: none"> • Standby Mode <ul style="list-style-type: none"> • Eco: The projector maintains at normal standby mode with less than 0.5W power consumption. • Normal: Allows the projector to provide network, monitor out and audio pass through functions in standby mode. • Audio Pass Through The projector can play sound when it is in standby mode and the corresponding jacks are correctly connected to devices. Press ◀/▶ to choose the source that you wish to use. See Connection on page 20 for how to make the connection.
<p>Operation Settings</p>	<ul style="list-style-type: none"> • LED Indicator You can turn off the LED warning lights. This is to avoid any light disturbance when viewing images in a dark room. • Power On/Off Settings <ul style="list-style-type: none"> • Direct Power On: Allows the projector to turn on automatically once the power is fed through the power cord. • Signal Power On: Sets whether to turn the projector directly on without pressing  POWER or  ON when the projector is in standby mode and detects a HDMI or DisplayPort signal. • Auto Power Off: Allows the projector to turn off automatically if no input signal is detected after a set period of time to prevent unnecessary waste of light source life.
<p>Page Up/Down</p>	<p>When this function is enabled, the PAGE▲/PAGE▼ buttons on the remote control can be used to perform page up/down commands.</p> <div style="display: flex; align-items: center;">  <p>Once enabled, the USB power delivery function will not be available.</p> </div>

• Panel Key Lock

With the control keys on the projector and remote control locked, you can prevent your projector settings from being changed accidentally (by children, for example). When the **Panel Key Lock** is on, no control keys on the projector and remote control will operate except  **POWER**.

Security Settings

To release panel key lock, press and hold  (the right key) on the projector or remote control for 3 seconds.



If you turn off the projector without disabling panel key lock, the projector will still be in locked status the next time it is turned on.

• Password/Power On Lock

See [Utilizing the password function on page 25](#).

Factory Default



Returns all settings to the factory preset values.

The following settings will still remain: **Projector Position, 2D Keystone, Auto Vertical Keystone, High Altitude Mode, Baud Rate, Corner Fit, Blanking, Light Source Information, Security Settings, Wall Color, Digital Shrink & Shift.**

Reset System



Returns all the settings on the **System** main menu to the factory default values.

The following settings will still remain: **Light Source Information, Security Settings.**

6. Main menu: **Information**

Structure

Menu
Native Resolution
Detected Resolution
Source
Picture Mode
Light Source Mode
3D Format
Color System
Dynamic Range
Light Source Usage Time
Firmware Version
Service Code

Function descriptions

Menu	Descriptions
Native Resolution	Shows the native resolution of the projector.
Detected Resolution	Shows the native resolution of the input signal.
Source	Shows the current signal source.
Picture Mode	Shows the selected mode on the Picture menu.
Light Source Mode	Shows the used light source mode.
	Displays the current 3D mode.
3D Format	 3D Format is only available when 3D is enabled.
Color System	Shows the input system format.
Dynamic Range	Shows the dynamic range of the input source.
Light Source Usage Time	Shows the number of hours the light has been used.
Firmware Version	Shows the firmware version of your projector.
Service Code	Shows the projector's serial number.

Maintenance

Care of the projector

Cleaning the lens

Clean the lens whenever you notice dirt or dust on the surface. Please be sure to turn off the projector and let it cool down completely before cleaning the lens.

- Use a canister of compressed air to remove dust.
- If there is dirt or smears, use lens-cleaning paper or moisten a soft cloth with lens cleaner and gently wipe the lens surface.
- Never use any type of abrasive pad, alkaline/acid cleaner, scouring powder, or volatile solvent, such as alcohol, benzene, thinner or insecticide. Using such materials or maintaining prolonged contact with rubber or vinyl materials may result in damage to the projector surface and cabinet material.

Cleaning the projector case

Before you clean the case, turn the projector off using the proper shutdown procedure as described in [Shutting down the projector on page 27](#) and unplug the power cord.

- To remove dirt or dust, wipe the case with a soft, lint-free cloth.
- To remove stubborn dirt or stains, moisten a soft cloth with water and a neutral pH detergent. Then wipe the case.



Never use wax, alcohol, benzene, thinner or other chemical detergents. These can damage the case.

Storing the projector

If you need to store the projector for an extended time, please follow the instructions below:

- Make sure the temperature and humidity of the storage area are within the recommended range for the projector. Please refer to [Specifications on page 50](#) or consult your dealer about the range.
- Retract the adjuster feet.
- Remove the battery from the remote control.
- Pack the projector in its original packing or equivalent.

Transporting the projector

It is recommended that you ship the projector with its original packing or equivalent.

Light source information

Getting to know the light hour

When the projector is in operation, the duration (in hours) of light source usage is automatically calculated by the built-in timer. The method of calculating the equivalent light hour is as follows:

1. Light Usage Time = (x+y+z) hours, if
Time used in **Normal Mode** = x hours

Time used in **ECO Mode** = y hours
 Time used in **SmartEco Mode** = z hours
 Time used in **Custom Mode** = a hours

2. Equivalent Light Hour = α hours

$$\alpha = \frac{A'}{X} \times \chi + \frac{A'}{Y} \times y + \frac{A'}{Z} \times z + \frac{A'}{A} \times a, \text{ if}$$

X= light source life spec of **Normal Mode**

Y= light source life spec of **ECO Mode**

Z= light source life spec of **SmartEco Mode**

A= light source life spec of **Custom Mode**

A' is the longest light life spec among X, Y, Z, A



For time used in each light source mode shown in OSD menu:

- Time used is accumulated and rounded down to an integer in **hours**.
- When time used is less than 1 hour, it shows 0 hours.



When you calculate **Equivalent Light Hours** manually, it will probably have deviation from the value shown in OSD menu since projector system calculates time used for each light source mode in “Minutes” then rounds down to an integer in hours shown in OSD.

To obtain the light source hour information:

1. Go to **Advanced** menu - **Settings** > **Light Usage Time** and press **OK**.
2. The **Light Usage Time** information is displayed.

You can also get the light source hour information on the **Information** menu.

Extending light source life

- Setting the **Light Source Mode**

Go to **Advanced** menu - **Picture** > **Advanced Color Settings** > **Light Source Mode** and select a suitable light source power from among the provided modes.

Setting the projector in **ECO**, **SmartEco** or **Custom** mode extends light source life.

Light mode	Description
Normal Mode	Provides full light source brightness
ECO Mode	Lowers brightness to extend the light source life and decreases the fan noise
SmartEco Mode	Adjusts the light source power automatically depending on the content brightness level while optimizing display quality
Custom Mode	Enables the light source brightness adjustment bar so that you can adjust the setting to your liking















































Some of the above light mode(s) may not be available under certain circumstances.









- Setting **Auto Power Off**

This function allows the projector to turn off automatically if no input signal is detected after a set period of time to prevent unnecessary waste of light source life.

To set **Auto Power Off**, go to **Advanced** menu - **System** > **Operation Settings** > **Power On/Off Settings** > **Auto Power Off** and press ◀/▶.

Indicators

Light			Status & Description
POWER ○	TEMP ○	LIGHT ○	
Power events			
			Stand-by mode
			Powering up
			Normal operation
			Normal power-down cooling
			Download
			Color wheel start/spin failure
			Phosphor wheel start/spin fail
Burn-in events			
			Burn-in on
			Burn-in off
Light events			
			Light life exhausted
			Light error in normal operation
Thermal events			
			Fan 1 error (the actual fan speed is outside the desired speed)
			Fan 2 error (the actual fan speed is outside the desired speed)
			Fan 3 error (the actual fan speed is outside the desired speed)
			Temperature 1 error (over limited temperature)

	 : off	 : Orange On	 : Green On	 : Red On
		 : Orange Flashing	 : Green Flashing	 : Red Flashing

Troubleshooting

? The projector does not turn on.

Cause	Remedy
There is no power from the power cord.	Plug the power cord into the AC power jack on the projector, and plug the power cord into the power outlet. If the power outlet has a switch, make sure that it is switched on.
Attempting to turn the projector on again during the cooling process.	Wait until the cooling down process has completed.

? No picture

Cause	Remedy
The video source is not turned on or connected correctly.	Turn the video source on and check that the signal cable is connected correctly.
The projector is not correctly connected to the input signal device.	Check the connection.
The input signal has not been correctly selected.	Select the correct input signal with the SOURCE key.

? Blurred image

Cause	Remedy
The projection lens is not correctly focused.	Adjust the focus of the lens using the focus ring.
The projector and the screen are not aligned properly.	Adjust the projection angle and direction as well as the height of the projector if necessary.
The lens cover is still closed.	Open the lens cover.

? Abnormal image

Cause	Remedy
The image is abnormal.	<ul style="list-style-type: none"> • Ensure the video source cable is connected properly, and that the video source is turned on. • Ensure that the air intake or exhaust is not blocked.

? Remote control does not work.

Cause	Remedy
The batteries are out of power.	Replace both of the batteries with new ones.
There is an obstacle between the remote control and the projector.	Remove the obstacle.
You are too far away from the projector.	Stand within 8 meters (26 feet) of the projector.

? The password is incorrect.

Cause	Remedy
You do not remember the password.	See Entering the password recall procedure on page 26 .

Specifications

Projector specifications



All specifications are subject to change without notice.

Optical

Resolution

LW650: 1280 x 800 WXGA

LH650: 1920 x 1080 1080p

Display system

1-CHIP DMD

Lens

F = 2.59 ~ 2.87, f = 16.88 ~ 21.88 mm

Light source

Laser and LED

Electrical

Power supply

AC100–240V, 3 A, 50–60 Hz (Automatic)

Power consumption

275 W (Max); < 0.5 W (Standby)

Mechanical

Weight

2.9 Kg ± 100 g (6.39 lbs ± 0.22 lbs)

Output terminals

Speaker

10 watt x1

Audio signal output

PC audio jack x 1

Control

USB

Type-A power supply 5V /1.5 A x 1

Type-A power supply 5V /1 A x 1 for WiFi dongle

RS-232 serial control

9 pin x 1

IR receiver x 2

Input terminals

Video signal input

SD/HDTV signal input

Digital - HDMI x 2

USB Type C input

USB Type C Input DP (Display) ALT Mode and DC

5V/1A Out x 1

Environmental Requirements

Operating temperature

0°C–40°C at sea level

Operating relative humidity

10%–90% (without condensation)

Operating altitude

0–1500 m at 0°C–35°C

1501–3000 m at 0°C–30°C (with

High Altitude Mode on)

Storage temperature

-20°C–60°C at sea level

Storage humidity

10%–90% RH (without condensation)

Storage altitude

30°C@ 0~12,200m above sea level

Transporting

Original packing or equivalent is recommended

Repairing

Please visit below website and choose your country to find your service contact window.

<http://www.benq.com/welcome>

Dimensions

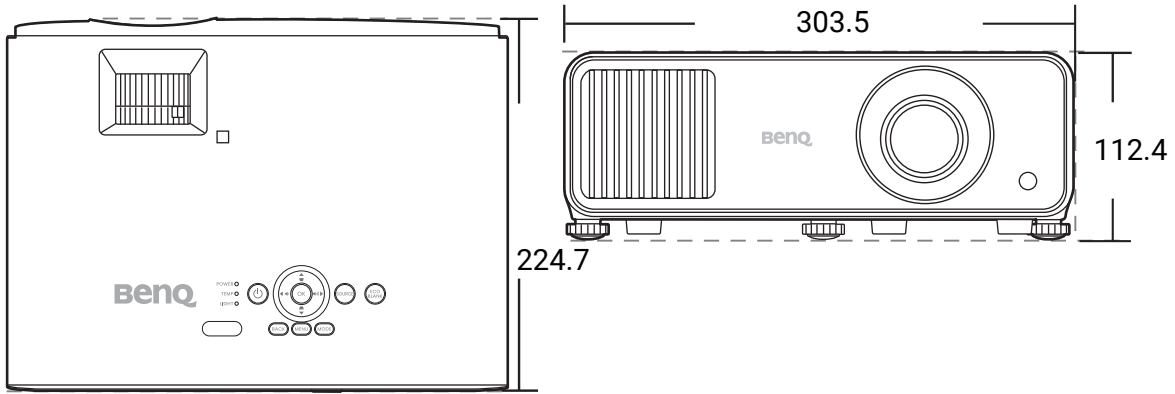

Unit: mm

Timing chart

Supported timing for HDMI (HDCP) input

- PC timings

Resolution	Mode	Vertical Frequency (Hz)	Horizontal Frequency (kHz)	Pixel Frequency (MHz)	Supported 3D format		
					Frame Sequential	Top Bottom	Side by Side
640 x 480	VGA_60	59.940	31.469	25.175	Supported	Supported	Supported
	VGA_72	72.809	37.861	31.500			
	VGA_75	75.000	37.500	31.500			
	VGA_85	85.008	43.269	36.000			
720 x 400	720 x 400_70	70.087	31.469	28.3221			
800 x 600	SVGA_60	60.317	37.879	40.000	Supported	Supported	Supported
	SVGA_72	72.188	48.077	50.000			
	SVGA_75	75.000	46.875	49.500			
	SVGA_85	85.061	53.674	56.250			
1024 x 768	SVGA_120 (Reduce Blanking)	119.854	77.425	83.000	Supported		
	XGA_60	60.004	48.363	65.000	Supported	Supported	Supported
	XGA_70	70.069	56.476	75.000			
	XGA_75	75.029	60.023	78.750			
	XGA_85	84.997	68.667	94.500			
1152 x 864	XGA_120 (Reduce Blanking)	119.989	97.551	115.5	Supported		
	1152 x 864_75	75	67.5	108			
1024 x 576@60Hz	BenQ Notebook Timing	60.00	35.820	46.996			
1024 x 600@65Hz	BenQ Notebook Timing	64.995	41.467	51.419			
1280 x 720	1280 x 720_60	60	45.000	74.250	Supported	Supported	Supported
1280 x 768	1280 x 768_60	59.870	47.776	79.5	Supported	Supported	Supported
1280 x 800	WXGA_60	59.810	49.702	83.500	Supported	Supported	Supported
	WXGA_75	74.934	62.795	106.500			
	WXGA_85	84.880	71.554	122.500			
	WXGA_120 (Reduce Blanking)	119.909	101.563	146.25	Supported		
1280 x 1024	SXGA_60	60.020	63.981	108.000		Supported	Supported
	SXGA_75	75.025	79.976	135.000			
	SXGA_85	85.024	91.146	157.500			
1280 x 960	1280 x 960_60	60.000	60.000	108		Supported	Supported
	1280 x 960_85	85.002	85.938	148.500			
1360 x 768	1360 x 768_60	60.015	47.712	85.500		Supported	Supported
1440 x 900	WXGA+_60	59.887	55.935	106.500		Supported	Supported
1400 x 1050	SXGA+_60	59.978	65.317	121.750		Supported	Supported
1600 x 1200	UXGA	60.000	75.000	162.000		Supported	
1680 x 1050	1680 x 1050_60	59.954	65.290	146.250		Supported	Supported
640 x 480@67Hz	MAC13	66.667	35.000	30.240			
832 x 624@75Hz	MAC16	74.546	49.722	57.280			
1024 x 768@75Hz	MAC19	75.020	60.241	80.000			
1152 x 870@75Hz	MAC21	75.06	68.68	100.00			
1920 x 1080@60Hz	1920 x 1080_60	60	67.5	148.5	Supported	Supported	Supported
1920 x 1200@60Hz	1920 x 1200_60 (Reduce Blanking)	59.950	74.038	154.000	Supported	Supported	Supported
1920 x 1080@120Hz	1920 x 1080_120	120.000	135.000	297			
1920 x 1200@120Hz	1920 x 1200_120 (Reduce Blanking)	119.909	152.404	317.00			
3840 x 2160	3840 x 2160_30	30	67.5	297			
3840 x 2160	3840 x 2160_60 For 4K2K model (Only HDMI 2.0 supports)	60	135	594			



The timings showing above may not be supported due to EDID file and VGA graphic card limitations. It is possible that some timings cannot be chosen.

• Video timings

Timing	Resolution	Horizontal Frequency (kHz)	Vertical Frequency (Hz)	Pixel Frequency (MHz)	Supported 3D format			
					Frame Sequential	Frame Packing	Top Bottom	Side by Side
480i	720 (1440) x 480	15.73	59.94	27	Supported			
480p	720 x 480	31.47	59.94	27	Supported			
576i	720 (1440) x 576	15.63	50	27				
576p	720 x 576	31.25	50	27				
720/50p	1280 x 720	37.5	50	74.25		Supported	Supported	Supported
720/60p	1280 x 720	45.00	60	74.25	Supported	Supported	Supported	Supported
1080/24P	1920 x 1080	27	24	74.25		Supported	Supported	Supported
1080/25P	1920 x 1080	28.13	25	74.25				
1080/30P	1920 x 1080	33.75	30	74.25				
1080/50i	1920 x 1080	28.13	50	74.25				Supported
1080/60i	1920 x 1080	33.75	60	74.25				Supported
1080/50P	1920 x 1080	56.25	50	148.5			Supported	Supported
1080/60P	1920 x 1080	67.5	60	148.5	Supported		Supported	Supported
1080/120P	1920 x 1080	135	120	297	Supported			
2160/24P	3840 x 2160 (Only HDMI 2.0 supports)	54	24	297				
2160/25P	3840 x 2160 (Only HDMI 2.0 supports)	56.25	25	297				
2160/30P	3840 x 2160 (Only HDMI 2.0 supports)	67.5	30	297				
2160/50P	3840 x 2160 (Only HDMI 2.0 supports)	112.5	50	594				
2160/60P	3840 x 2160 (Only HDMI 2.0 supports)	135	60	594				

• Supported detail timings for sampling and color depth

Display format (refresh rate)	Chroma subsampling	8 Bit	10 Bit	12 Bit
4K/60p (60 Hz)	4:4:4	Supported		
	4:2:2	Supported	Supported	Supported
	4:2:0	Supported	Supported	Supported
4K/60p (50 Hz)	4:4:4	Supported		
	4:2:2	Supported	Supported	Supported
	4:2:0	Supported	Supported	Supported
4K/60p (30 Hz)	4:4:4	Supported	Supported	Supported
	4:2:2	Supported	Supported	Supported
	4:2:0			
4K/60p (24 Hz)	4:4:4	Supported	Supported	Supported
	4:2:2	Supported	Supported	Supported
	4:2:0			

Supported timing for USB-C input

• PC timings

Resolution	Mode	Vertical Frequency (Hz)	Horizontal Frequency (kHz)	Pixel Frequency (MHz)
640 x 480	VGA_60	59.940	31.469	25.175
	VGA_72	72.809	37.861	31.500
	VGA_75	75.000	37.500	31.500
	VGA_85	85.008	43.269	36.000
720 x 400	720 x 400_70	70.087	31.469	28.3221
800 x 600	SVGA_60	60.317	37.879	40.000
	SVGA_72	72.188	48.077	50.000
	SVGA_75	75.000	46.875	49.500
	SVGA_85	85.061	53.674	56.250
	SVGA_120	119.854	77.425	83.000
1024 x 768	XGA_60	60.004	48.363	65.000
	XGA_70	70.069	56.476	75.000
	XGA_75	75.029	60.023	78.750
	XGA_85	84.997	68.667	94.500
	XGA_120	119.989	97.551	115.500
1152 x 864	1152 x 864_75	75.00	67.500	108.000
1280 x 720	1280 x 720_60	60	45.000	74.250
	1280 x 720_120	120	90.000	148.500
1280 x 768	1280 x 768_60	60	47.396	68.25
	1280 x 768_60	59.870	47.776	79.5
1280 x 800	WXGA_60	59.810	49.702	83.500
	WXGA_75	74.934	62.795	106.500
	WXGA_85	84.880	71.554	122.500
	WXGA_120	119.909	101.563	146.25
1280 x 1024	SXGA_60	60.020	63.981	108.000
	SXGA_75	75.025	79.976	135.000
	SXGA_85	85.024	91.146	157.500
1280 x 960	1280 x 960_60	60.000	60.000	108
	1280 x 960_85	85.002	85.938	148.500
1366 x 768	1366 x 768_60	59.790	47.712	85.500
1440 x 900	WXGA+_60	60	55.469	88.75
	WXGA+_60	59.887	55.935	106.500
1400 x 1050	SXGA+_60	59.978	65.317	121.750
1600 x 1200	UXGA	60.000	75.000	162.000
1680 x 1050	1680 x 1050_60	59.883	64.674	119.000
	1680 x 1050_60	59.954	65.290	146.250
1920 x 1200	1920 x 1200_60	59.950	74.038	154.000
640 x 480	MAC13	66.667	35.000	30.240
832 x 624	MAC16	74.546	49.722	57.280
1024 x 768	MAC19	75.020	60.241	80.000
1152 x 870	MAC21	75.06	68.68	100.00
1920 x 1080 (VESA)	1920 x 1080_60	60	67.5	148.5
1920 x 1080	1920 x 1080_120	120.00	135.000	297.000
3840 x 2160	3840 x 2160_30	30	67.5	297
3840 x 2160	3840 x 2160_60	60	135	594

- Video timings

Timing	Resolution	Horizontal Frequency (kHz)	Vertical Frequency (Hz)	Pixel Frequency (MHz)
480i	720 (1440) x 480	15.73	59.94	27
480p	720 x 480	31.47	59.94	27
576i	720 (1440) x 576	15.63	50	27
576p	720 x 576	31.25	50	27
720/50p	1280 x 720	37.5	50	74.25
720/60p	1280 x 720	45.00	60	74.25
1080/50i	1920 x 1080	28.13	50	74.25
1080/60i	1920 x 1080	33.75	60	74.25
1080/24P	1920 x 1080	27	24	74.25
1080/50P	1920 x 1080	56.25	50	148.5
1080/60P	1920 x 1080	67.5	60	148.5
2160/24P	3840 x 2160	54	24	297
2160/25P	3840 x 2160	56.25	25	297
2160/30P	3840 x 2160	67.5	30	297
2160/50P	3840 x 2160	112.5	50	594
2160/60P	3840 x 2160	135	60	594