



# Digital Projector

# User Manual

LX710 / LX710D / LU710 / LU710D / LH710 / LH710D  
LX730 / LX730D / LU930 / LU930D / LH930 / LH930D

V 1.02

# Warranty and Copyright information

## Limited warranty

BenQ warrants this product against any defects in material and workmanship, under normal usage and storage.

Proof of purchase date will be required with any warranty claim. In the event this product is found to be defective within the warranty period, BenQ's only obligation and your exclusive remedy shall be replacement of any defective parts (labor included). To obtain warranty service, immediately notify the dealer from which you purchased the product of any defects.

Important: The above warranty shall be void if the customer fails to operate the product in accordance with BenQ's written instructions, especially the ambient humidity must be in-between 10% and 90%, temperature in-between 0°C and 35°C, altitude lower than 4920 feet, and avoiding to operate the projector in a dusty environment. This warranty gives you specific legal rights, and you may have other rights which vary from country to country.

For other information, please visit [www.BenQ.com](http://www.BenQ.com).

## Copyright

Copyright © 2023 by BenQ Corporation. All rights reserved. No part of this publication may be reproduced, transmitted, transcribed, stored in a retrieval system or translated into any language or computer language, in any form or by any means, electronic, mechanical, magnetic, optical, chemical, manual or otherwise, without the prior written permission of BenQ Corporation.

## Disclaimer

BenQ Corporation makes no representations or warranties, either expressed or implied, with respect to the contents hereof and specifically disclaims any warranties, merchantability or fitness for any particular purpose. Further, BenQ Corporation reserves the right to revise this publication and to make changes from time to time in the contents hereof without obligation to notify any person of such revision or changes.

\*DLP, Digital Micromirror Device and DMD are trademarks of Texas Instruments. Others are copyrights of their respective companies or organizations.

The terms HDMI, HDMI High-Definition Multimedia Interface, HDMI Trade dress and the HDMI Logos are trademarks or registered trademarks of HDMI Licensing Administrator, Inc.

# Table of Contents

<b>Warranty and Copyright information</b> .....	<b>2</b>
<b>Important safety instructions</b> .....	<b>4</b>
<b>Introduction</b> .....	<b>6</b>
Shipping contents .....	6
Projector exterior view .....	8
Controls and functions.....	9
<b>Positioning your projector</b> .....	<b>11</b>
Choosing a location .....	11
Obtaining a preferred projected image size.....	12
Mounting the projector .....	16
Adjusting the projector position (LU930/LU930D/LH930/LH930D) .....	18
Adjusting the projected image .....	19
<b>Connection</b> .....	<b>21</b>
<b>Operation</b> .....	<b>23</b>
Starting up the projector .....	23
Using the menus .....	24
Securing the projector .....	25
Switching input signal .....	27
Controlling the projector through a Wired LAN environment .....	27
Shutting down the projector .....	30
Direct power off .....	30
<b>Menu operation</b> .....	<b>31</b>
<b>Basic</b> menu .....	36
<b>Advanced</b> menu .....	38
<b>Maintenance</b> .....	<b>48</b>
Care of the projector .....	48
Light source information .....	49
<b>Troubleshooting</b> .....	<b>51</b>
<b>Specifications</b> .....	<b>52</b>
Projector specifications .....	52
Dimensions .....	53
Timing chart.....	54

# Important safety instructions

Your projector is designed and tested to meet the latest standards for safety of information technology equipment. However, to ensure safe use of this product, it is important that you follow the instructions mentioned in the user manual / installation guide and marked on the product.

1. **Please read the user manual / installation guide before you operate your projector.** Save it for future reference.
2. **Do not look straight at the projector lens during operation.** The intense light beam may damage your eyes.
3. **Refer servicing to qualified service personnel.**
4. **Always open the lens shutter (if any) or remove the lens cap (if any) when the projector light source is on.**
5. The light source becomes extremely hot during operation.
6. In some countries, the line voltage is NOT stable. This projector is designed to operate safely within a mains voltage between 100 to 240 volts AC, but could fail if power cuts or surges of  $\pm 10$  volts occur. **In areas where the mains voltage may fluctuate or cut out, it is recommended that you connect your projector through a power stabilizer, surge protector or uninterruptible power supply (UPS).**
7. Do not block the projection lens with any objects when the projector is under operation as this could cause the objects to become heated and deformed or even cause a fire. To temporarily turn off the light source, use the blank function.
8. Do not operate light sources beyond the rated light source life.
9. Do not place this product on an unstable cart, stand, or table. The product may fall, sustaining serious damage.
10. Do not attempt to disassemble this projector. There are dangerous high voltages inside which may cause death if you should come into contact with live parts.

Under no circumstances should you ever undo or remove any other covers. Refer servicing only to suitably qualified professional service personnel.

11. Do not block the ventilation holes.
  - Do not place this projector on a blanket, bedding or any other soft surface.
  - Do not cover this projector with a cloth or any other item.
  - Do not place inflammables near the projector.If the ventilation holes are seriously obstructed, overheating inside the projector may result in a fire.
12. Do not stand the projector on end vertically. Doing so may cause the projector to fall over, causing injury or resulting in damage to the projector.
13. Do not step on the projector or place any objects upon it. Besides probable physical damage to the projector, doing so may result in accidents and possible injury.
14. When the projector is under operation, you may sense some heated air and odor from its ventilation grill. It is a normal phenomenon and not a product defect.
15. Do not place liquids near or on the projector. Liquids spilled into the projector may cause it to fail. If the projector does become wet, disconnect it from the power supply's power outlet and call BenQ to have the projector serviced.
16. This apparatus must be earthed.
17. Do not place this projector in any of the following environments.



- Space that is poorly ventilated or confined. Allow at least 50 cm clearance from walls and free flow of air around the projector.
- Locations where temperatures may become excessively high, such as the inside of a car with all windows rolled up.
- Locations where excessive humidity, dust, or cigarette smoke may contaminate optical components, shorten the projector's life span and darken the image.
- Locations near fire alarms
- Locations with an ambient temperature above 40°C / 104°F
- Locations where the altitudes are higher than 3000 m (10000 feet).

18. To avoid damaging the DLP chips, do not direct a high-power laser beam onto the projection lens.

## Risk Group 2

1. According to the classification of photobiological safety of light sources and light source systems, this product is Risk Group 2, IEC 62471-5:2015.
2. Possibly hazardous optical radiation emitted from this product.
3. Do not stare at operating light source. May be harmful to the eyes.
4. As with any bright source, do not stare into the direct beam.



The projector's light source unit uses a laser.

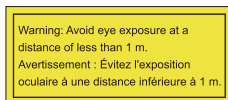

- Notice is given to supervise children and to never allow them to stare into the projector beam at any distance from the projector.
- Notice is given to use caution when using the remote control for starting the projector while in front of the projection lens.
- Notice is given to the user to avoid the use of optical aids such as binoculars or telescopes inside the beam.

## Laser Caution

This product belongs to CLASS I consumer laser product and complies with IEC 60825-1:2014, EN 60825-1:2014/A11:2021 and EN 50689:2021.

**LASER RADIATION, DO NOT STARE INTO BEAM, CLASS I LASER PRODUCT.**



Above laser caution are located on the bottom of this apparatus.

Caution – Use of controls or adjustments or performance of procedures other than those specified herein may result in hazardous radiation exposure.

# Introduction

## Shipping contents

Carefully unpack and verify that you have all of the items shown below. If any of these items are missing, please contact your place of purchase.

### Standard accessories

LX710/LX710D/LU710/  
LU710D/LH710/LH710D

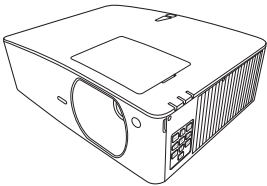

LX730/LX730D

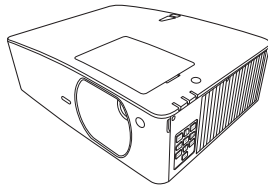

LU930/LU930D/LH930/  
LH930D

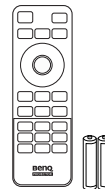
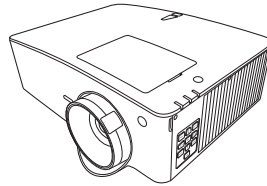

Projector

Remote control with batteries



Quick start guide



Warranty card\*

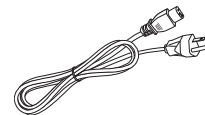

Power cord

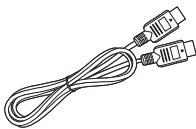

HDMI cable



• The supplied accessories will be suitable for your region, and may differ from those illustrated.

• \*The warranty card is only supplied in some specific regions. Please consult your dealer for detailed information.

### Optional accessories

1. 3D glasses
2. InstaShow™ (WDC10/WDC20)
3. Wireless dongles (QCast Mirror)

### Replacing the remote control batteries

1. Press and slide off the battery cover, as illustrated.
2. Remove the old batteries (if applicable) and install two AAA batteries. Make sure that the positive and negative ends are positioned correctly, as illustrated.
3. Slide the battery cover in until it clicks into place.

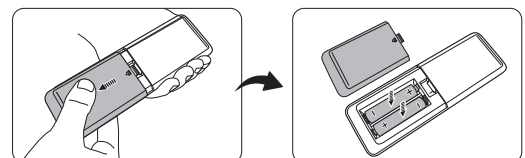



- Avoid leaving the remote control and batteries in an excessive heat or humid environment like the kitchen, bathroom, sauna, sunroom or in a closed car.
- Replace only with the same or equivalent type recommended by the battery manufacturer.
- Dispose of the used batteries according to the manufacturer's instructions and local environment regulations for your region.
- Never throw the batteries into a fire. There may be danger of an explosion.
- If the batteries are dead or if you will not be using the remote control for an extended period of time, remove the batteries to avoid damage to the remote control from possible battery leakage.

# Projector exterior view

LX710/LX710D/LU710/  
LU710D/LH710/LH710D

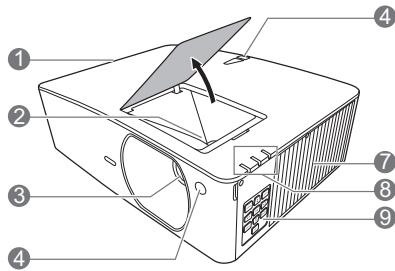

LX730/LX730D

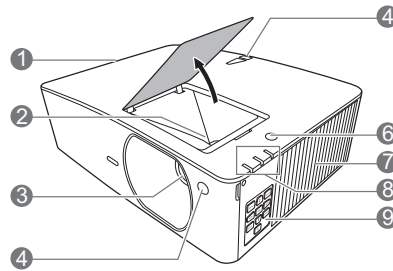

LU930/LU930D/LH930/  
LH930D

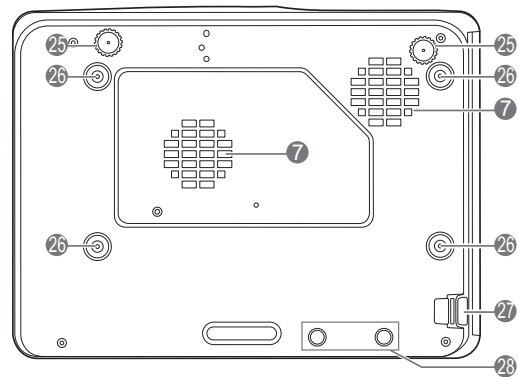
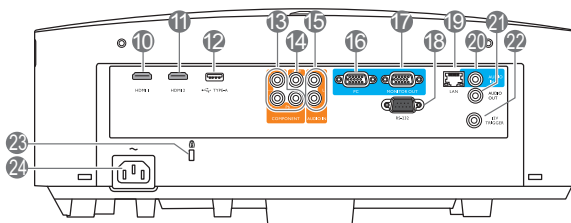
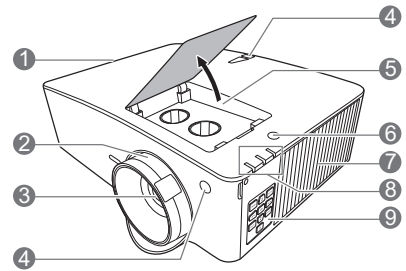

- 1. Vent (air exhaust)
- 2. Focus and zoom ring
- 3. Projection lens
- 4. IR remote sensor
- 5. Lens shift adjustment knobs (LEFT/RIGHT, UP/DOWN)
- 6. Ambient Light Sensor (ALS)
- 7. Vent (air inlet)
- 8. **POWER indicator light/TEMPERature warning light/LIGHT indicator light** (See [Indicators on page 50.](#))
- 9. External control panel (See [Controls and functions on page 9.](#))
- 10. HDMI 1 input port
- 11. HDMI 2 input port
- 12. USB Type A port (5V/1.5A power for WDC10/QCast Mirror)
- 13. Component RCA RGB input jacks
- 14. Video input jack
- 15. Audio (L/R) input jacks
- 16. RGB (PC) signal input jack
- 17. RGB (PC) signal output jack
- 18. RS-232 control port
- 19. RJ-45 LAN input jack
- 20. Audio input jack
- 21. Audio output jack
- 22. 12V trigger
- 23. Anti-theft lock slot
- 24. AC power jack
- 25. Adjuster feet
- 26. Wall mount holes
- 27. Security bar
- 28. InstaShow holes



\*Power for WDC20 should come from external power supply.

# Controls and functions

## Projector & Remote control



All the key presses described in this document are available on the remote control or projector.

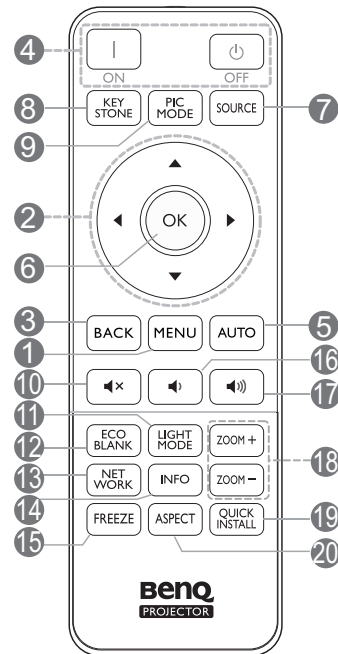
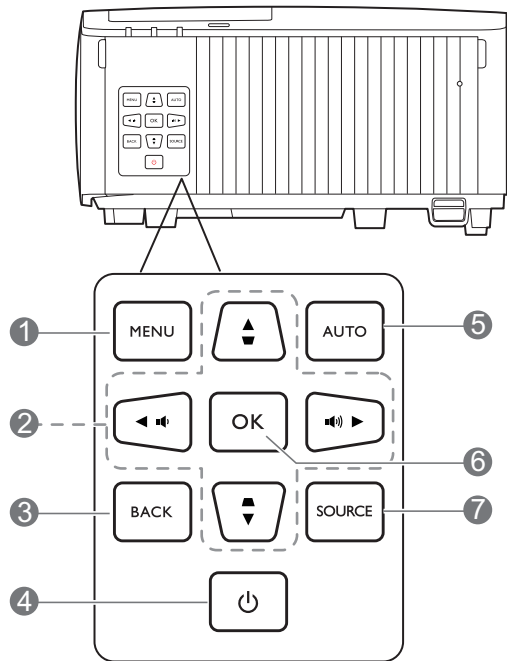

### 1. MENU

Turns on the On-Screen Display (OSD) menu.

### 2. Arrow keys (▲, ▼, ◀, ▶)

When the On-Screen Display (OSD) menu is activated, these keys are used as directional arrows to select the desired menu items and to make adjustments.

Keystone keys (▴, ▾)

Displays the keystone correction page.

Volume keys (🔊/🔊)

Decreases or increases the projector volume.

### 3. BACK

Goes back to previous OSD menu, exits and saves menu settings.

### 4. POWER

Toggles the projector between standby mode and on.

⏻ ON/ ⏻ Off

Toggles the projector between standby mode and on.

### 5. AUTO

Automatically determines the best picture timings for the displayed image when PC signal (analog RGB) is selected.

6. **OK**

Confirms the selected On-Screen Display (OSD) menu item.

7. **SOURCE**

Displays the source selection bar.

8. **KEYSTONE**

Displays the keystone correction page.

9. **PIC MODE**

Selects an available picture setup mode.

10. **🔊×**

Toggles projector audio between on and off.

11. **LIGHT MODE**

Selects an available light mode.

12. **ECO BLANK**

Used to hide the screen picture.



Do not block the projection lens from projecting as this could cause the blocking object to become heated and deformed or even cause a fire.

13. **NETWORK**

Displays the network settings menu.

14. **INFO**

Displays the projector information.

15. **FREEZE**

Freezes the projected image.

16. **🔊**

Decreases the projector volume.

17. **🔊)**

Increases the projector volume.

18. **ZOOM+/ZOOM-**

Magnifies or reduces the projected picture size.

19. **QUICK INSTALL**

Quickly selects several functions to adjust the projected image and displays the test pattern.

20. **ASPECT**

Selects the display aspect ratio.

## Remote control effective range

The remote control must be held at an angle within 30 degrees perpendicular to the projector's IR remote control sensor(s) to function correctly. The distance between the remote control and the sensor(s) should not exceed 8 meters (~ 26 feet).

Make sure that there are no obstacles between the remote control and the IR sensor(s) on the projector that might obstruct the infra-red beam.

- Operating the projector from the front

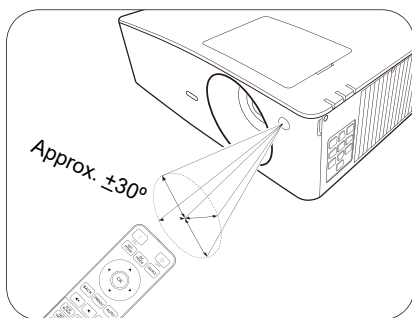

- Operating the projector from the top

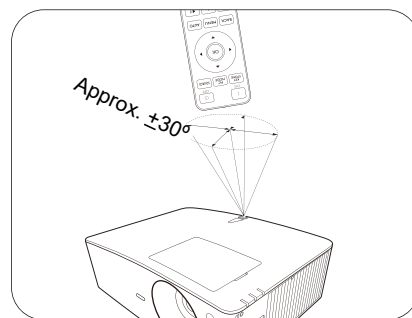

# Positioning your projector

## Choosing a location

Before choosing an installation location for your projector, take the following factors into consideration:

- Size and position of your screen
- Electrical outlet location
- Location and distance between the projector and the rest of your equipment

You can install your projector in the following ways.

---

### 1. Front Table

Select this location with the projector placed on the table in front of the screen. This is the most common way to position the projector for quick setup and portability.

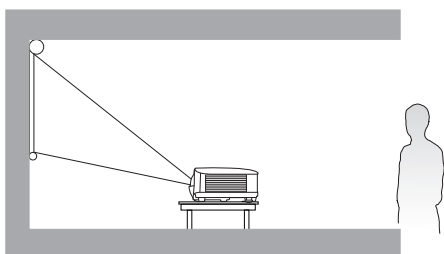

### 2. Rear Table

Select this location with the projector placed on the table behind the screen. Note that a special rear projection screen is required.

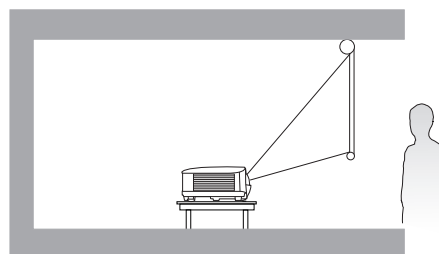

### 3. Front Ceiling

Select this location with the projector suspended upside-down from the ceiling in front of the screen. Purchase the BenQ Projector Ceiling Mount Kit from your dealer to mount your projector on the ceiling.

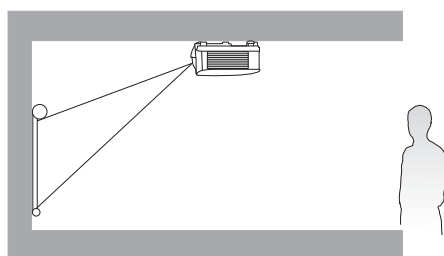

### 4. Rear Ceiling

Select this location with the projector suspended upside-down from the ceiling behind the screen. Note that a special rear projection screen and the BenQ Projector Ceiling Mount Kit are required for this installation location.

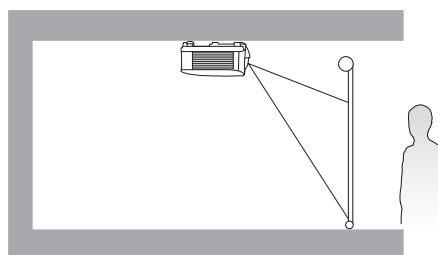

---

After turning on the projector, go to **Advanced Menu - Settings > Projector Installation > Projector Installation** and press ◀/▶ to select a setting.

You can also use **QUICK INSTALL** on the remote control to access this menu.

# Obtaining a preferred projected image size

The distance from the projector lens to the screen, the zoom setting (if available), and the video format each factors in the projected image size.

## Projection dimensions

### LX710/LX710D/LX730/LX730D

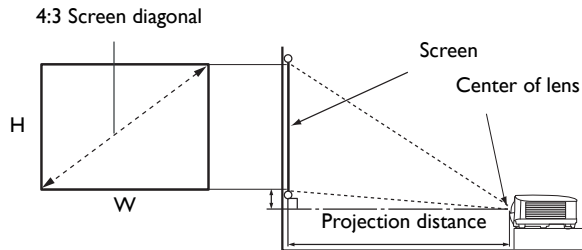

- The screen aspect ratio is 4:3 and the projected picture is in a 4:3 aspect ratio

LX710/LX710D							
Screen size				Projection distance (mm)			Offset (mm)
Diagonal		H (mm)	W (mm)	Min distance	Average	Max distance	
Inch	mm			(max. zoom)		(min. zoom)	
30	762	457	610	920	1061	1201	34
50	1270	762	1016	1534	1768	2002	57
60	1524	914	1219	1841	2121	2402	69
70	1778	1067	1422	2148	2475	2802	80
80	2032	1219	1626	2455	2829	3202	91
90	2286	1372	1829	2761	3182	3603	103
100	2540	1524	2032	3068	3536	4003	114
110	2794	1676	2235	3375	3889	4403	126
120	3048	1829	2438	3682	4243	4804	137
130	3302	1981	2642	3989	4596	5204	149
140	3556	2134	2845	4296	4950	5604	160
150	3810	2286	3048	4602	5304	6005	171
160	4064	2438	3251	4909	5657	6405	183
170	4318	2591	3454	5216	6011	6805	194
180	4572	2743	3658	5523	6364	7205	206
200	5080	3048	4064	6137	7071	8006	229
250	6350	3810	5080	7671	8839	10008	286
300	7620	4572	6096	9205	10607	12009	343

For example, if you are using a 120-inch screen, the recommended projection distance is 4243 mm.

If your measured projection distance is 6000 mm, the closest match in the "Projection distance (mm)" column is 6005 mm. Looking across this row shows that a 150" (about 3.8 m) screen is required.



LX730/LX730D							
Screen size				Projection distance (mm)			Offset (mm)
Diagonal		H (mm)	W (mm)	Min distance	Average	Max distance	
Inch	mm			(max. zoom)		(min. zoom)	
30	762	457	610	860	1116	1372	46
50	1270	762	1016	1433	1859	2286	76
60	1524	914	1219	1719	2231	2743	91
70	1778	1067	1422	2006	2603	3200	107
80	2032	1219	1626	2292	2975	3658	122
90	2286	1372	1829	2579	3347	4115	137
100	2540	1524	2032	2865	3719	4572	152
110	2794	1676	2235	3152	4090	5029	168
120	3048	1829	2438	3438	4462	5486	183
130	3302	1981	2642	3725	4834	5944	198
140	3556	2134	2845	4011	5206	6401	213
150	3810	2286	3048	4298	5578	6858	229
200	5080	3048	4064	5730	7437	9144	305
250	6350	3810	5080	7163	9296	11430	381
300	7620	4572	6096	8595	11156	13716	457

For example, if you are using a 120-inch screen, the recommended projection distance is 4462 mm.

If your measured projection distance is 5000 mm, the closest match in the "Projection distance (mm)" column is 4834 mm. Looking across this row shows that a 130" (about 3.3 m) screen is required.



- To optimize your projection quality, we suggest you do the projection within non-gray area.
- All measurements are approximate and may vary from the actual sizes. BenQ recommends that if you intend to permanently install the projector, you should physically test the projection size and distance using the actual projector in situ before you permanently install it, so as to make allowance for this projector's optical characteristics. This will help you determine the exact mounting position so that it best suits your installation location.

## LU710/LU710D/LU930/LU930D

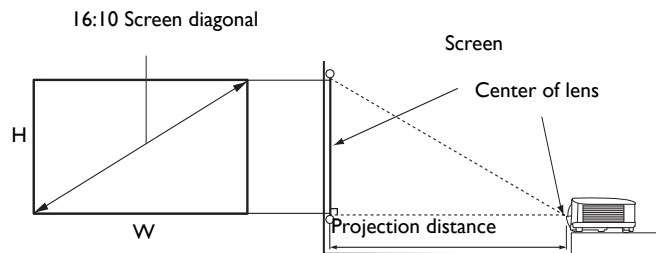

- The screen aspect ratio is 16:10 and the projected picture is in a 16:10 aspect ratio

LU710/LU710D							
Screen size				Projection distance (mm)			Offset (mm)
Diagonal		H (mm)	W (mm)	Min distance	Average	Max distance	
Inch	mm			(max. zoom)		(min. zoom)	
30	762	404	646	730	837	943	0
50	1270	673	1077	1217	1395	1572	0
60	1524	808	1292	1460	1674	1887	0
70	1778	942	1508	1704	1953	2201	0
80	2032	1077	1723	1947	2231	2516	0
90	2286	1212	1939	2191	2510	2830	0
100	2540	1346	2154	2434	2789	3145	0
110	2794	1481	2369	2677	3068	3459	0
120	3048	1615	2585	2921	3347	3774	0
130	3302	1750	2800	3164	3626	4088	0
140	3556	1885	3015	3407	3905	4403	0
150	3810	2019	3231	3651	4184	4717	0
200	5080	2692	4308	4868	5579	6289	0
250	6350	3365	5385	6085	6973	7862	0
300	7620	4039	6462	7302	8368	9434	0

For example, if you are using a 120-inch screen, the recommended projection distance is 3347 mm.

If your measured projection distance is 4000 mm, the closest match in the "Projection distance (mm)" column is 3905 mm. Looking across this row shows that a 140" (about 3.6 m) screen is required.

LU930/LU930D							
Screen size				Projection distance (mm)			Offset (mm)
Diagonal		H (mm)	W (mm)	Min distance	Average	Max distance	
Inch	mm			(max. zoom)		(min. zoom)	
30	762	404	646	879	1144	1409	0
50	1270	673	1077	1465	1906	2348	0
60	1524	808	1292	1758	2287	2817	0
70	1778	942	1508	2051	2669	3287	0
80	2032	1077	1723	2343	3050	3756	0
90	2286	1212	1939	2636	3431	4226	0
100	2540	1346	2154	2929	3812	4696	0
110	2794	1481	2369	3222	4194	5165	0
120	3048	1615	2585	3515	4575	5635	0
130	3302	1750	2800	3808	4956	6104	0
140	3556	1885	3015	4101	5337	6574	0
150	3810	2019	3231	4394	5719	7043	0
200	5080	2692	4308	5859	7625	9391	0
250	6350	3365	5385	7323	9531	11739	0
300	7620	4039	6462	8788	11437	14087	0

For example, if you are using a 120-inch screen, the recommended projection distance is 4575 mm.

If your measured projection distance is 4000 mm, the closest match in the "Projection distance (mm)" column is 3812 mm. Looking across this row shows that a 100" (about 2.8 m) screen is required.



- To optimize your projection quality, we suggest you do the projection within non-gray area.
- All measurements are approximate and may vary from the actual sizes.  
BenQ recommends that if you intend to permanently install the projector, you should physically test the projection size and distance using the actual projector in situ before you permanently install it, so as to make allowance for this projector's optical characteristics. This will help you determine the exact mounting position so that it best suits your installation location.

## LH710/LH710D/LH930/LH930D

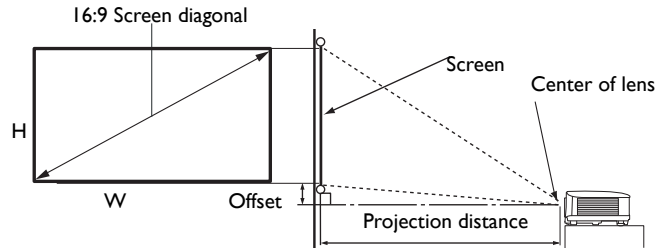

- The screen aspect ratio is 16:9 and the projected picture is in a 16:9 aspect ratio

LH710/LH710D							
Screen size				Projection distance (mm)			Offset (mm)
Diagonal		H (mm)	W (mm)	Min distance	Average	Max distance	
Inch	mm			(max. zoom)		(min. zoom)	
30	762	374	664	750	860	970	19
50	1270	623	1107	1251	1433	1616	31
60	1524	747	1328	1501	1720	1939	37
70	1778	872	1550	1751	2007	2263	44
80	2032	996	1771	2001	2293	2586	50
90	2286	1121	1992	2251	2580	2909	56
100	2540	1245	2214	2502	2867	3232	62
110	2794	1370	2435	2752	3154	3555	68
120	3048	1494	2657	3002	3440	3879	75
130	3302	1619	2878	3252	3727	4202	81
140	3556	1743	3099	3502	4014	4525	87
150	3810	1868	3321	3752	4300	4848	93
200	5080	2491	4428	5003	5734	6464	125
250	6350	3113	5535	6254	7167	8080	156
300	7620	3736	6641	7505	8601	9696	187

For example, if you are using a 120-inch screen, the recommended projection distance is 3440 mm.

If your measured projection distance is 4000 mm, the closest match in the "Projection distance (mm)" column is 4014 mm. Looking across this row shows that a 140" (about 3.6 m) screen is required.

LH930/LH930D							
Screen size				Projection distance (mm)			Offset (mm)
Diagonal		H (mm)	W (mm)	Min distance	Average	Max distance	
Inch	mm			(max. zoom)		(min. zoom)	
30	762	374	664	903	1176	1448	0
50	1270	623	1107	1505	1959	2413	0
60	1524	747	1328	1806	2351	2896	0
70	1778	872	1550	2108	2743	3378	0
80	2032	996	1771	2409	3135	3861	0
90	2286	1121	1992	2710	3527	4343	0
100	2540	1245	2214	3011	3918	4826	0
110	2794	1370	2435	3312	4310	5309	0
120	3048	1494	2657	3613	4702	5791	0
130	3302	1619	2878	3914	5094	6274	0
140	3556	1743	3099	4215	5486	6757	0
150	3810	1868	3321	4516	5878	7239	0
200	5080	2491	4428	6022	7837	9652	0
250	6350	3113	5535	7527	9796	12065	0
300	7620	3736	6641	9032	11755	14478	0

For example, if you are using a 120-inch screen, the recommended projection distance is 4702 mm.

If your measured projection distance is 4000 mm, the closest match in the "Projection distance (mm)" column is 3918 mm. Looking across this row shows that a 100" (about 2.5 m) screen is required.



- To optimize your projection quality, we suggest you do the projection within non-gray area.
- All measurements are approximate and may vary from the actual sizes. BenQ recommends that if you intend to permanently install the projector, you should physically test the projection size and distance using the actual projector in situ before you permanently install it, so as to make allowance for this projector's optical characteristics. This will help you determine the exact mounting position so that it best suits your installation location.

## Mounting the projector

If you intend to mount your projector, we strongly recommend that you use a proper fitting BenQ projector mounting kit and that you ensure it is securely and safely installed.

If you use a non-BenQ brand projector mounting kit, there is a safety risk that the projector may fall down due to an improper attachment through the use of the wrong gauge or length screws.

### Before mounting the projector

- Purchase a BenQ projector mounting kit from the place you purchased your BenQ projector.
- BenQ recommends that you also purchase a separate Kensington lock compatible security cable and attach it securely to both the anti-theft lock slot on the projector and the base of the mounting bracket. This will perform the secondary role of restraining the projector should its attachment to the mounting bracket become loose.
- Ask your dealer to install the projector for you. Installing the projector on your own may cause it to fall and result in injury.
- Take necessary procedures to prevent the projector from falling off such as during an earthquake.
- The warranty doesn't cover any product damage caused by mounting the projector with a non-BenQ brand projector mounting kit.

- Consider the surrounding temperature where the projector is ceiling/wall mounted. If a heater is used, the temperature around the ceiling may be higher than expected.
- Read the user manual for the mounting kit about the range of torque. Tightening with torque exceeding the recommended range may cause damage to the projector and subsequently falling off.
- Make sure the power outlet is at an accessible height so that you can easily shut down the projector.

## Ceiling/Wall mount installation diagram

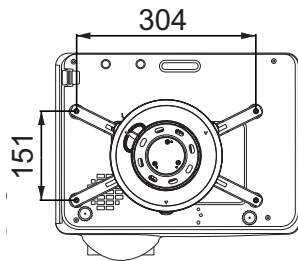

BenQ ceiling mount CMG3 (5J.JAM10.001)  
 Ceiling mount screw: M4  
 (Max. L = 25 mm; Min. L = 20 mm)

Unit: mm

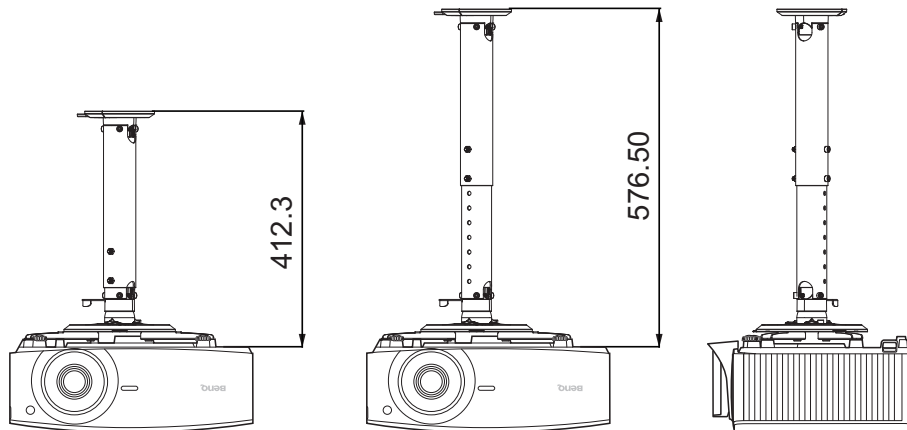

# Adjusting the projector position (LU930/LU930D/LH930/LH930D)



## Shifting the projection lens

The lens shift control provides flexibility for installing your projector. It allows the projector to be positioned off the center of the screen.

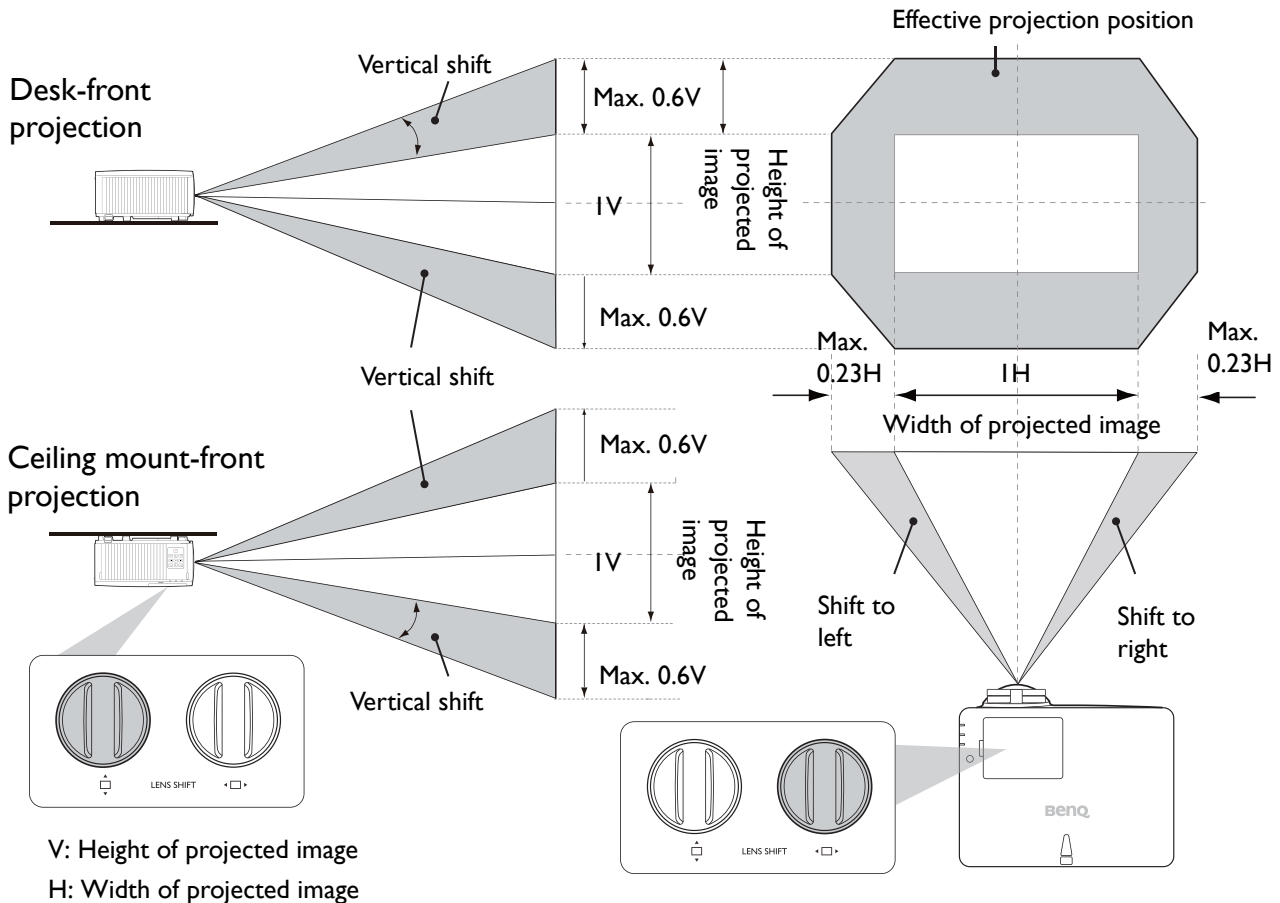
The lens shift is expressed as a percentage of the projected image height or width. You can turn the knobs on the projector to shift the projection lens in any direction within the allowable range depending on your desired image position.



To reach the highest or lowest projection position:

1. Turn  (Up/Down).
2. When you feel it is reaching the limit, turn  (Left/Right) to the left or right and turn  again.
3. Repeat the step above until finding the suitable position you need.

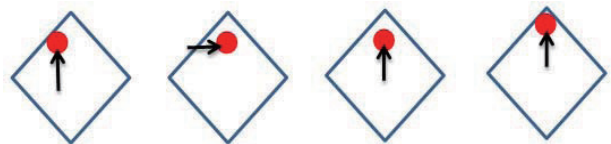

- If you hear a “clicking sound” during the adjustment, it means that the knob is past its adjustment limit. Please stop adjusting it, in order to avoid any unexpected damage, and turn the knob in the opposite direction, at least to one step before the click.
- If you can’t turn it back, please press and turn the knob back at same time.

# Adjusting the projected image

## Adjusting the projection angle

If the projector is not placed on a flat surface or the screen and the projector are not perpendicular to each other, the projected image becomes trapezoidal. You can screw the adjuster feet to fine-tune the horizontal angle.

To retract the feet, screw the adjuster feet in a reverse direction.

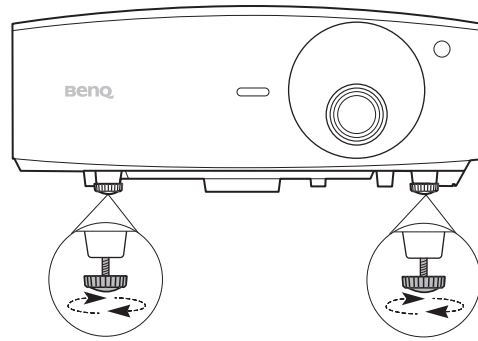

Do not look into the lens while the light source is on. The strong light from the light source may cause damage to your eyes.

## Fine-tuning the image size and clarity

Adjust the projected image to the size that you need using the zoom ring.

Sharpen the image by rotating the focus ring.

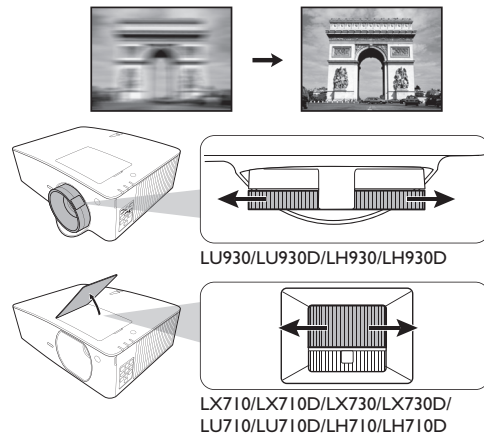
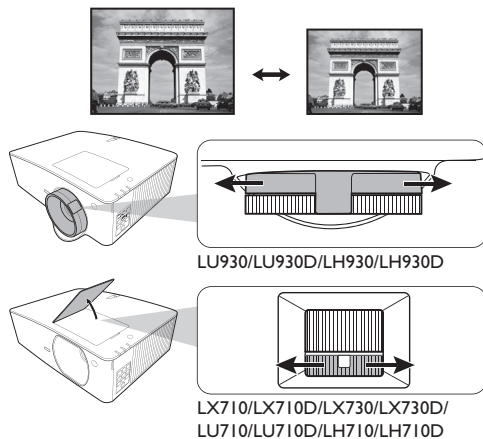

## Correcting keystone

Keystoning refers to the situation where the projected image becomes a trapezoid due to angled projection.

To correct trapezoidal distortion, you can activate the **Auto Vertical Keystone** function in the **Advanced Menu - Display** menu. Or you can manually correct it following these steps.

1. Do one of the following steps to display the keystone correction page.

- Press **▲** / **▼** or **▲** / **▼** on the projector or remote control.
- Press **QUICK INSTALL** on the remote control. Press **▼** to highlight **2D Keystone** and press **OK**.
- Go to **Advanced Menu - Display > 2D Keystone** and press **OK**.

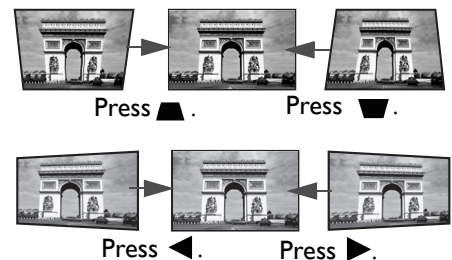

2. After the **2D Keystone** correction page displays. Press **▲** to correct keystone at the top of the image. Press **▼** to correct keystone at the bottom of the image. Press **◀** to correct keystone at the right side of the image. Press **▶** to correct keystone at the left side of the image.

3. When **2D Keystone** correction page displays, you can also do the following settings:
  - Press **AUTO** to reset the keystone values.
  - Press **▲/▼** to disable the auto vertical keystone function.

## Adjusting Corner Fit

You can manually adjust four corners of the image by setting the horizontal and vertical values.

1. Do one of the following steps to display the corner fit correction page.
  - Press **QUICK INSTALL** on the remote control. Press **▼** to highlight **Corner Fit** and press **OK**.
  - Go to **Advanced Menu - Display > Corner Fit** and press **OK**.
2. Press **▲/▼/◀/▶** to select one corner and press **OK**.
3. Press **▲/▼** to adjust vertical values.
4. Press **◀/▶** to adjust horizontal values.

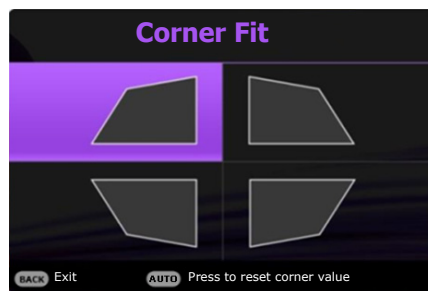



# Connection

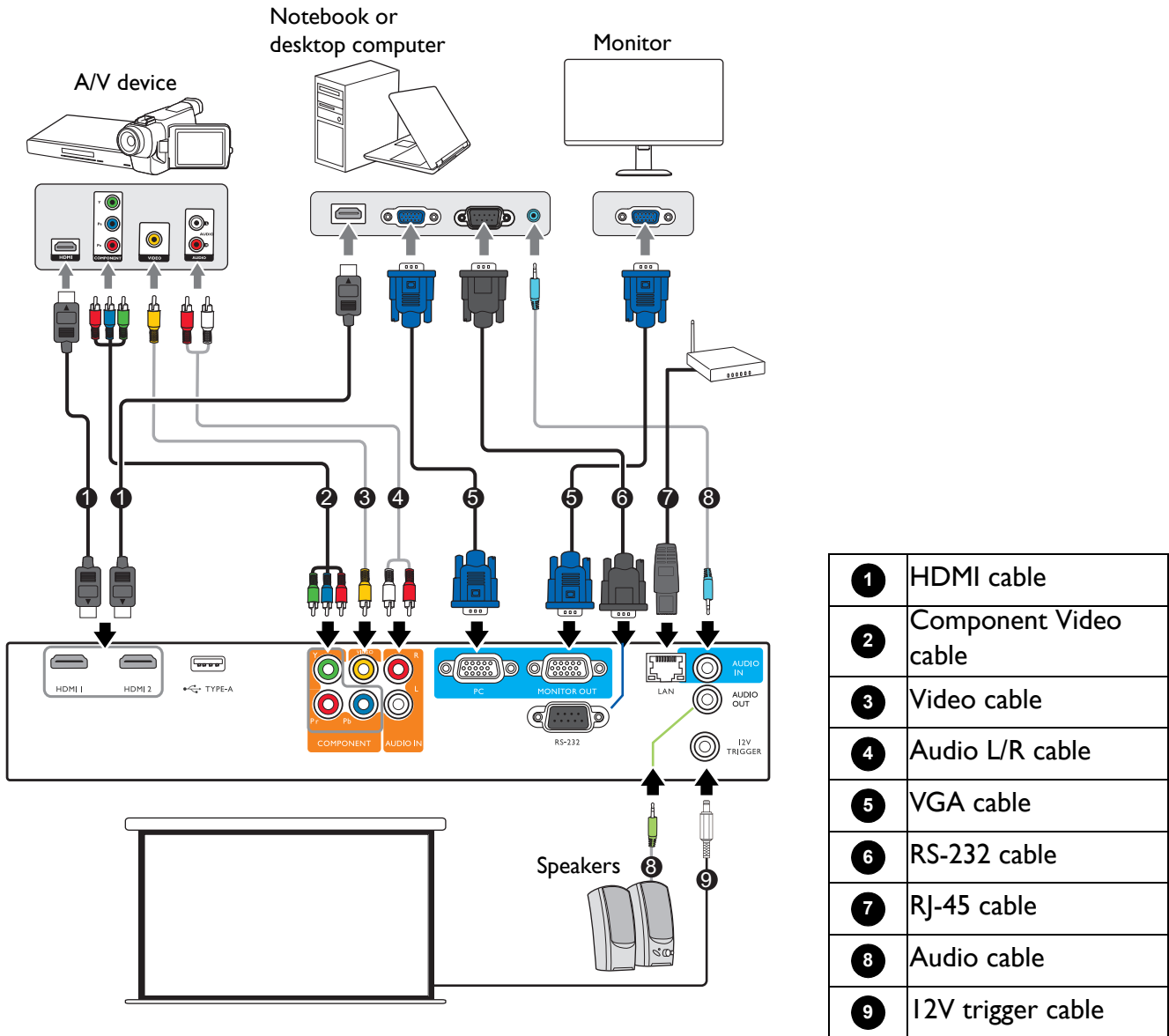

When connecting a signal source to the projector, be sure to:

1. Turn all equipment off before making any connections.
2. Use the correct signal cables for each source.
3. Ensure the cables are firmly inserted.



- In the connections above, some cables may not be included with the projector (see [Shipping contents on page 6](#)). They are commercially available from electronics stores.
- The connection illustrations are for reference only. The rear connecting jacks available on the projector vary with each projector model.
- Many notebooks do not turn on their external video ports when connected to a projector. Usually a key combo like FN + function key with a monitor symbol turns the external display on/off. Press FN and the labeled function key simultaneously. Refer to your notebook's documentation to find your notebook's key combination.
- If the selected video image is not displayed after the projector is turned on and the correct video source has been selected, check that the video source device is turned on and operating correctly. Also check that the signal cables have been connected correctly.

You need only connect the projector to a video source device using just one of the connecting methods, however each provides a different level of video quality.

Terminal		Picture quality
<b>HDMI I</b>		Best
<b>Component Video</b>		Better
<b>Video</b>		Normal

### Connecting audio

The projector has built-in mono speaker(s) which are designed to provide basic audio functionality accompanying data presentations for business purposes only. They are not designed for, nor intended for stereo audio reproduction use as might be expected in home theater or home cinema applications. Any stereo audio input (if provided), is mixed into a common mono audio output through the projector speaker(s).



The built-in speaker(s) will be muted when the **AUDIO OUT** jack is connected.



- The projector is only capable of playing mixed mono audio, even if a stereo audio input is connected.
- If the selected video image is not displayed after the projector is turned on and the correct video source has been selected, check that the video source device is turned on and operating correctly. Also check that the signal cables have been connected correctly.

# Operation

## Starting up the projector

1. Plug the power cord. Turn on the power outlet switch (where fitted). The power indicator on the projector lights orange after power has been applied.
2. Press  on the projector or  on the remote control to start the projector. The power indicator flashes green and stays green when the projector is on.

The start up procedure takes about 30 seconds. In the later stage of start up, a startup logo is projected.

(If necessary) Rotate the focus ring to adjust the image clearness.

3. If the projector is activated for the first time, select your OSD language following the on-screen instructions.
4. If you are prompted for a password, press the arrow keys to enter a 6-digit password. See [Utilizing the password function on page 25](#).
5. Switch all of the connected equipment on.
6. The projector will search for input signals. The current input signal being scanned appears. If the projector does not detect a valid signal, the message “No Signal” will continue displaying until an input signal is found.

You can also press **SOURCE** to select your desired input signal. See [Switching input signal on page 27](#).

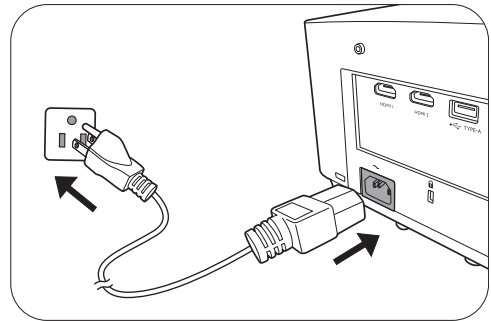

- Please use the original accessories (e.g. power cord) to avoid possible dangers such as electric shock and fire.
- If the projector is still hot from previous activity, it will run the cooling fan for approximately 90 seconds before energizing the light source.



- The Setup Wizard screenshots are for reference only and may differ from the actual design.
- If the frequency/resolution of the input signal exceeds the projector's operating range, you will see the message “Out of Range” displayed on the background screen. Please change to an input signal which is compatible with the projector's resolution or set the input signal to a lower setting. See [Timing chart on page 54](#).
- If no signal is detected for 3 minutes, the projector automatically enters saving mode.

## Using the menus

The projector is equipped with 2 types of On-Screen Display (OSD) menus for making various adjustments and settings.

- **Basic** OSD menu: provides primary menu functions. (See [Basic menu on page 36](#))
- **Advanced** OSD menu: provides full menu functions. (See [Advanced menu on page 38](#))

To access the OSD menu, press **MENU** on the projector or remote control.

- Use the arrow keys (**▲/▼/◀/▶**) on the projector or remote control to move through the menu items.
- Use **OK** on the projector or remote control to confirm the selected menu item.

The first time you use the projector (after finishing the initial setup), **Advanced** OSD menu displays.



The OSD screenshots below are for reference only, and may differ from the actual design.

Below is the overview of the **Advanced** OSD menu.

1	Main menu & Main menu icon	5	Press <b>BACK</b> to go to the previous page.
2	Sub-menu	6	Press <b>MENU</b> to exit.
3	Current input signal	7	Status
4	Press <b>OK</b> to enter the menu.		

If you intend to switch from the **Advanced** OSD menu to the **Basic** OSD menu, follow the instructions below:

1. Go to **Advanced Menu - System > Menu Settings** and press **OK**.
2. Select **Menu Type** and **OK**.
3. Press **▲/▼** to select **Basic**. Next time when you turn on the projector, you may access the **Basic** OSD menu by pressing **MENU**.

Below is the overview of the **Basic** OSD menu.

	<p>1 Menu Type</p>	<p>4 Press <b>OK</b> to enter the menu.</p>
<p>2 Main menu</p>	<p>5 Status</p>	
<p>3 Current input signal</p>	<p>6 Press <b>MENU</b> to exit.</p>	

Likewise, when you wish to switch from the **Basic** OSD menu to the **Advanced** OSD menu, follow the instructions below:

1. Go to **Basic Menu > Menu Type**.
2. Press **OK** and press **▲/▼** to select **Advanced**. Next time when you turn on the projector, you may access the **Advanced** OSD menu by pressing **MENU**.

## Securing the projector

### Using a security cable lock

The projector has to be installed in a safe place to prevent theft. Otherwise, purchase a lock, such as the Kensington lock, to secure the projector. You can locate an anti-theft lock slot on the rear side of the projector. See item 23 on [page 8](#).

A Kensington security cable lock is usually a combination of key(s) and the lock. Refer to the lock's documentation for finding out how to use it.

### Utilizing the password function

#### Setting a password

1. Go to **Advanced Menu - Settings > Security Settings**. Press **OK**. The **Security Settings** page appears.
2. Highlight **Change Password** and press **OK**.
3. The four arrow keys (**▲**, **▶**, **▼**, **◀**) respectively represent 4 digits (1, 2, 3, 4). According to the password you desire to set, press the arrow keys to enter six digits for the password.
4. Confirm the new password by re-entering the new password.
5. To activate the **Power On Lock** function, press **▲/▼** to highlight **Power On Lock** and press **OK**. Press **◀/▶** to select **On**. Input the password again.

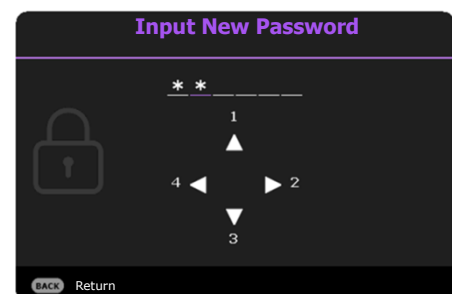



- The digits being input will display as asterisks on-screen. Make a note of your selected password and keep it in a safe place in advance or right after the password is entered so that it is available to you should you ever forget it.
- Once a password has been set and the power on lock is activated, the projector cannot be used unless the correct password is entered every time the projector is started.

## If you forget the password

If you enter the wrong password, the password error message will appear, and the **Input Current Password** message follows. If you absolutely do not remember the password, you can use the password recall procedure. See [Entering the password recall procedure on page 26](#).

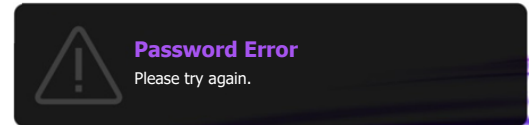

If you enter an incorrect password 5 times in succession, the projector will automatically shut down in a short time.

## Entering the password recall procedure

1. Press and hold **AUTO** for 3 seconds. The projector will display a coded number on the screen.
2. Write down the number and turn off your projector.
3. Seek help from the local BenQ service center to decode the number. You may be required to provide proof of purchase documentation to verify that you are an authorized user of the projector.

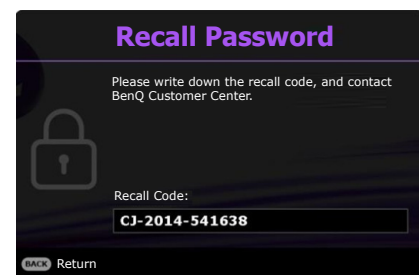

## Changing the password

1. Go to **Advanced Menu - Settings > Security Settings > Change Password**.
2. Press **OK**. The message “**Input Current Password**” appears.
3. Enter the old password.
  - If the password is correct, another message “**Input New Password**” appears.
  - If the password is incorrect, the password error message will appear, and the message “**Input Current Password**” appears for your retry. You can press **BACK** to cancel the change or try another password.
4. Enter a new password.
5. Confirm the new password by re-entering the new password.

## Disabling the password function

To disable password protection, go to **Advanced Menu - Settings > Security Settings > Power On Lock** and press **OK**. Press **◀/▶** to select **Off**. The message “**Input Current Password**” appears. Enter the current password.

- If the password is correct, the OSD menu returns to the **Security Settings** page. You will not have to enter the password next time turning on the projector.
- If the password is incorrect, the password error message will appear, and the message “**Input Current Password**” appears for your retry. You can press **BACK** to cancel the change or try another password.



Though the password function is disabled, you need to keep the old password in hand should you ever need to re-activate the password function by entering the old password.

## Switching input signal

The projector can be connected to multiple devices at the same time. However, it can only display one full screen at a time. When starting up, the projector automatically searches for the available signals.

Be sure the **Advanced Menu - Settings > Auto Source Search** menu is **On** if you want the projector to automatically search for the signals.

To select the source:

1. Press **SOURCE**. A source selection bar appears.
2. Press **▲/▼** until your desired signal is selected and press **OK**.

Once detected, the selected source information will appear at the corner of the screen for seconds. If there is multiple equipment connected to the projector, repeat steps 1-2 to search for another signal.

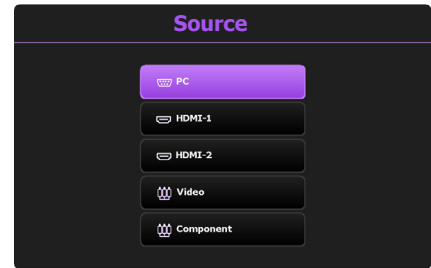

- The brightness level of the projected image will change accordingly when you switch between different input signals.
- For best display picture results, you should select and use an input signal which outputs at the projector's native resolution. Any other resolutions will be scaled by the projector depending upon the "aspect ratio" setting, which may cause some image distortion or loss of picture clarity. See [Aspect Ratio on page 36](#).

## Controlling the projector through a Wired LAN environment

Wired LAN allows you to manage the projector from a computer using a web browser when the computer and the projector are properly connected to the same local area network.

### Configuring the Wired LAN

**If you are in a DHCP environment:**

1. Take a RJ45 cable and connect one end to the RJ45 LAN input jack of the projector and the other end to the RJ45 port.



When connecting the RJ45 cable, avoid coiling and intertwining the cable as it may cause signal noise or interruption.

2. Make sure the menu type is **Advanced**. See [Using the menus on page 24](#) for how to switch to the **Advanced** OSD menu.
3. Go to **Advanced - Network**.
4. Highlight **Wired LAN** and then press **OK**. The **Wired LAN** page is displayed.
5. Press **▲/▼** to highlight **DHCP** and press **◀/▶** to select **On**.
6. Press **▲/▼** to highlight **Apply** and press **OK**.
7. Go back to the **Network** page.
8. Press **▲/▼** to highlight **AMX Device Discovery** and press **◀/▶** to select **On** or **Off**. When **AMX Device Discovery** is **On**, the projector can be detected by AMX controller.
9. Please wait for around 15 - 20 seconds, and then re-enter the **Wired LAN** page.

10. The **IP Address**, **Subnet Mask**, **Default Gateway**, and **DNS Server** settings will be displayed. Note down the IP address displayed in the **IP Address** row.



If the **IP Address** still does not display, contact your ITS administrator.

### If you are in a non-DHCP environment:

1. Repeat steps 1-4 above.
2. Press ▲/▼ to highlight **DHCP** and press ◀/▶ to select **Off**.
3. Contact your ITS administrator for information on the **IP Address**, **Subnet Mask**, **Default Gateway**, and **DNS Server** settings.
4. Press ▲/▼ to select the item you want to modify and press **OK**.
5. Press ◀/▶ to move the cursor and then press ▲/▼ to enter the value.
6. To save the setting, press **OK**. If you do not want to save the setting, press **BACK**.
7. Press **BACK** to return to **Wired LAN** page, press ▲/▼ to highlight **AMX Device Discovery** and press ◀/▶ to select **On** or **Off**.
8. Press **BACK** to exit the menu.

## Controlling the projector remotely through a web browser

Once you have the correct IP address for the projector and the projector is on or in standby mode, you can use any computer that is on the same local area network to control the projector.

1. Enter the address of the projector in the address bar of your browser and click Go.

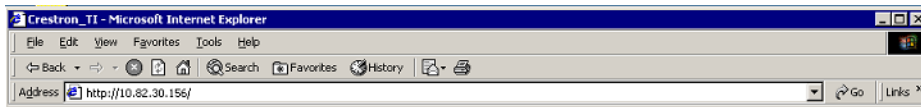

2. The remote network operation page opens. This page allows you to operate the projector as if you were using the remote control or control panel on the projector.



<p>• Menu (<b>MENU</b>)</p> <p>• <b>OK</b></p> <p>• ▲ (▼)</p> <p>• ◀</p> <p>• Blank (<b>ECO BLANK</b>)</p>	<p>• Input (<b>SOURCE</b>)</p> <p>• ▼ (▲)</p> <p>• ▶</p>	<p>See <a href="#">Projector &amp; Remote control on page 9</a> for details.</p>
--	--	--



**ii** To switch input source, click on your desired signal.

 The source list varies according to the connectors available on the projector. "Video" stands for the Video signal.

The tools page allows you to manage the projector, configure the **Network** settings and secure access of remote network operation on this projector.

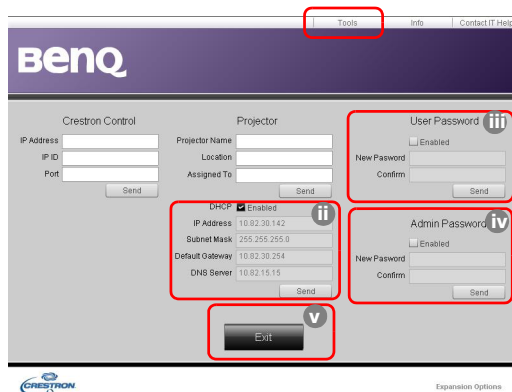

- i. You can name the projector, keep track of its location and the person in charge of it.
- ii. You can adjust the **Network** settings.
- iii. Once set, access to the remote network operation on this projector has been password-protected.
- iv. Once set, access to the tools page has been password-protected.

 After making the adjustments, press the Send button and the data will be saved in the projector.

- v. Press **Exit** to go back to the remote network operation page.

Please pay attention to the limitation of input length (including space and other punctuation keys) in the list below:



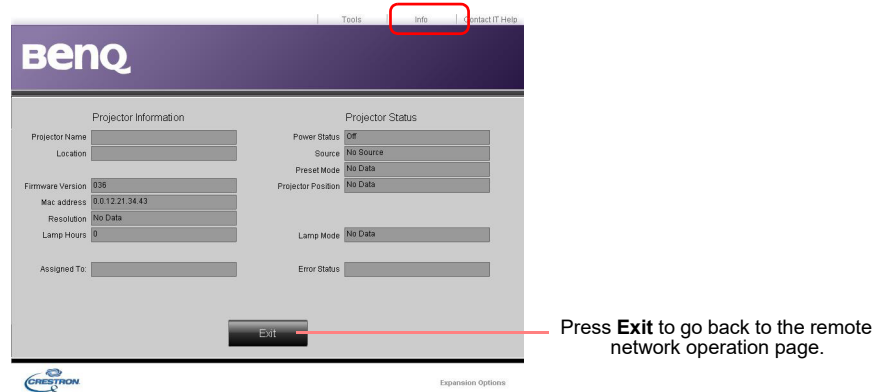

Category Item	Input Length	Maximum Number of Characters
Crestron Control	IP Address	15
	IP ID	4
	Port	5
Projector	Projector Name	22
	Comment	22
	Assigned To	22
Network Configuration	DHCP (Enabled)	(N/A)
	IP Address	15
	Subnet Mask	15
	Default Gateway	15
	DNS Server	15
User Password	Enabled	(N/A)
	New Password	15
	Confirm	15
Admin Password	Enabled	(N/A)
	New Password	15
	Confirm	15

The info page displays the information and status of this projector.



For more information, visit <http://www.crestron.com> & [www.crestron.com/getroomview](http://www.crestron.com/getroomview).

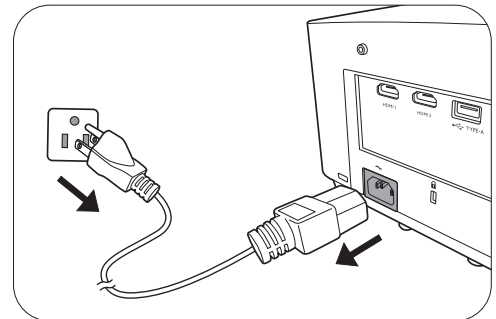

## Shutting down the projector

1. Press  on the projector or  on the remote control and a confirmation message will appear prompting you. If you don't respond in a few seconds, the message will disappear.
2. Press  or  a second time. The power indicator flashes orange, the projection light source shuts down, and the fans will continue to run for approximately 90 seconds to cool down the projector.
3. Once the cooling process finishes, the power indicator becomes a steady orange and fans stop. Disconnect the power cord from the power outlet.



- To protect the light source, the projector will not respond to any commands during the cooling process.
- Avoid turning on the projector immediately after turning it off as excessive heat may shorten light source life.
- Light source life results will vary depending on environmental conditions and usage.

## Direct power off

The AC power cord can be pulled out right after the projector is turned off. To protect the light source, wait about 10 minutes before re-starting the projector. If you attempt to re-start the projector, the fans may run for a few minutes to cool down. In such cases, press  or  again to start the projector after the fans stop and the power indicator turns orange.

# Menu operation

Please note that the on-screen display (OSD) menus vary according to the signal type selected and the projector model you are using.

The menu items are available when the projector detects at least one valid signal. If there is no equipment connected to the projector or no signal detected, limited menu items are accessible.

## Basic menu

Main menu	Options
Brightness	0~50~100
Aspect Ratio	Auto/Real/4:3/16:9/16:10
Picture Mode	Bright/Presentation/Infographic/Video/sRGB/(3D)/User 1/User 2
Volume	0~5~10
Light Mode	Normal/Economic/Dimming/Custom
LumiExpert Level	-2~0~2
Information	Native Resolution
	Detected Resolution
	Source
	Picture Mode
	Light Mode
	3D Format
	Color System
	Light Usage Time
	Firmware Version
	Service Code
Menu Type	Basic/Advanced

## Advanced menu



Main menu	Submenu	Options	
Picture	Picture Mode	Bright/Presentation/Infographic/Video/sRGB/(3D)/User 1/User 2	
	Reference Mode	Bright/Presentation/Infographic/Video/sRGB/(3D)	
	Brightness	0~50~100	
	Tint		
	Contrast	-50~0~50	
	Color	-50~0~50	
	Sharpness	0~15~31	
	Brilliant Color	On/Off	
		Color Temperature	Cool/Normal/Warm
			R Gain (0~50~100)
			G Gain (0~50~100)
			B Gain (0~50~100)
		Color Temperature Tuning	R Offset (-50~0~50)
			G Offset (-50~0~50)
			B Offset (-50~0~50)
		Advanced Color Settings	R (Primary Color/Hue/Saturation/Gain)
			G (Primary Color/Hue/Saturation/Gain)
			B (Primary Color/Hue/Saturation/Gain)
		Color Management	C (Primary Color/Hue/Saturation/Gain)
			M (Primary Color/Hue/Saturation/Gain)
			Y (Primary Color/Hue/Saturation/Gain)
		Wall Color	Off/Light Yellow/Pink/Light Green/Blue/Blackboard
		LumiExpert	On/Off
	LumiExpert (LX730/LX730D/LU930/LU930D/LH930/LH930D)	LumiExpert Level -2~0~2	
		Manual Calibration Status	
	Manual Calibration	Calibrate	
		Reset Manual Calibration	
	Reset Picture	Reset/Cancel	

Main menu	Submenu	Options	
Display	Aspect Ratio	Auto/Real/4:3/16:9/16:10	
	2D Keystone	H: -30~0~30 V: -30~0~30	
	Auto Vertical Keystone		
	Corner Fit		
	Test Pattern	Off/Grid W/Grid G/RGB Ramps	
	PC & Component YPbPr Tuning	Phase	
		H. Size	
	Position	H: -5~0~5	
		V: -5~0~5	
	3D	3D Mode	Auto/Top Bottom/Frame Sequential/Frame Packing/Side by Side/Off
		3D Sync Invert	Disable/Invert
		Apply 3D Settings	3D Settings 1/3D Settings 2/3D Settings 3/Off
		Save 3D Settings	3D Settings 1/3D Settings 2/3D Settings 3
	HDMI Format	Auto/RGB Limited/RGB Full/YUV Limited/YUV Full	
	Digital Zoom	PC: 1.0X/2.0X Video: 1.0X/1.8X	
		Digital Shrink & Shift	0.75X~1.0X
	Image Resizing	Modes of Adjustment	
		Blanking	Top Bottom Left Right
	Digital Lens Shift (LU710/LU710D/LU930/LU930D/LH710/LH710D/LH930/LH930D)		
	Reset Display		Reset/Cancel
	Network	Status	
		DHCP	On/Off
		IP Address	
Subnet Mask			
Default Gateway			
DNS Server			
Apply			
AMX Device Discovery		On/Off	
MAC Address (Wired)			

Main menu	Submenu	Options	
Settings	Projector Installation	Front Table/Rear Table/Rear Ceiling/Front Ceiling	
	Remote Receiver	Front/Top/Front+Top	
	Auto Source Search	On/Off	
	Auto Sync	On/Off	
	Dynamic Dimming	On/Off	
	Light Settings	Light Mode	Normal/Economic/Dimming/Custom
			Custom Brightness
		Light Usage Time	
		Blank Timer	Disable/5 min/10 min/15 min/20 min/25 min/30 min
		Reminder Message	On/Off
	Operation Settings	High Altitude Mode	On/Off
		Power On/Off Settings	Direct Power On
			Signal Power On
			Auto Power Off
		12V Trigger	On/Off
	Security Settings	Panel Key Lock	On/Off
		Change Password	
		Power On Lock	On/Off
	Baud Rate		9600/14400/19200/38400/57600/115200
	HDMI Equalizer	HDMI 1	Auto/Lower/Low/Middle/High/Higher
		HDMI 2	Auto/Lower/Low/Middle/High/Higher
	USB Power Switch		On/Off
	Reset Settings		Reset/Cancel

Main menu	Submenu	Options	
System	Language	English/Français/Deutsch/Italiano/Español/ Русский/繁體中文/简体中文/日本語/한국어/ Svenska / Nederlands / Türkçe / Čeština / Português/ไทย/PolSKI/Magyar/Hrvatski/ Română/Norsk/Dansk/Български / Suomi/Indonesian/Ελληνικά/العربية/हिंदी/ فارسی / Tiếng Việt	
	Standby Settings	Standby Mode	Eco/Network/Normal
		Auto Disable Network Standby Mode	Off/20 min/1 hr/3 hr/6 hr
		Audio Pass Through	Off/Audio in/Audio L/R/HDMI 1/HDMI 2
	Background Settings	Background	BenQ/Gray/Black/Blue/Purple
		Splash Screen	BenQ/Black/Blue
	Menu Settings	Menu Type	Basic/Advanced
		Menu Display Time	5 sec/10 sec/20 sec/30 sec/Always
	Audio Settings	Mute	On/Off
		Volume	0~5~10
		Power On/Off Ring Tone	On/Off
	Closed Caption	Closed Caption Enable	On/Off
		Caption Version	CC1/CC2/CC3/CC4
	Display Resolution Switch (LU710/LU710D/LU930/LU930D)		WUXGA/1080P
	Factory Default		Reset/Cancel
	Reset System		Reset/Cancel
	Information	Native Resolution	
		Detected Resolution	
		Source	
		Picture Mode	
Light Mode			
3D Format			
Color System			
Light Usage Time			
Firmware Version			

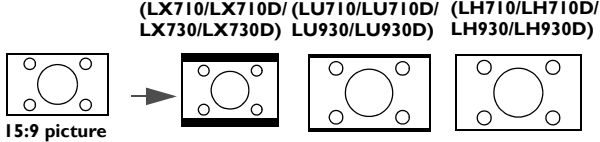
## Basic menu

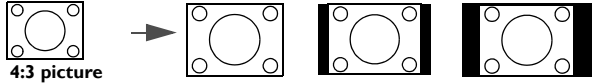
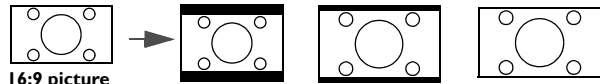
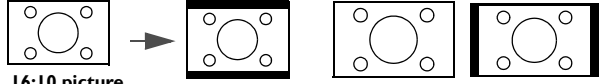
<p><b>Brightness</b></p>	<p>The higher the value, the brighter the image. Adjust this control so the black areas of the image appear just as black and that detail in the dark areas is visible.</p>
<p><b>Aspect Ratio</b></p>	<p>There are several options to set the image's aspect ratio depending on your input signal source.</p> <ul style="list-style-type: none"> <li> <p>• <b>Auto:</b> Scales an image proportionally to fit the projector's native resolution in its horizontal or vertical width.</p>  <p>(LX710/LX710D/ (LU710/LU710D/ (LH710/LH710D/ LX730/LX730D) LU930/LU930D) LH930/LH930D)</p> </li> <li> <p>• <b>Real:</b> Projects an image as its original resolution and resizes it to fit within the display area. For input signals with lower resolutions, the projected image will be displayed in its original size.</p>  <p>4:3 picture</p>  <p>16:9 picture</p> </li> <li> <p>• <b>4:3:</b> Scales an image so that it is displayed in the center of the screen with a 4:3 aspect ratio.</p>  <p>4:3 picture</p> </li> <li> <p>• <b>16:9:</b> Scales an image so that it is displayed in the center of the screen with a 16:9 aspect ratio.</p>  <p>16:9 picture</p> </li> <li> <p>• <b>16:10:</b> Scales an image so that it is displayed in the center of the screen with a 16:10 aspect ratio.</p>  <p>16:10 picture</p> </li> </ul>
<p><b>Picture Mode</b></p>	<p>The projector is preset with several predefined picture modes so that you can choose one to suit your operating environment and input signal picture type.</p> <ul style="list-style-type: none"> <li> <p>• <b>Bright:</b> Maximizes the brightness of the projected image. This mode is suitable for environments where extra-high brightness is required, such as using the projector in well lit rooms.</p> </li> <li> <p>• <b>Presentation:</b> Is designed for presentations. The brightness is emphasized in this mode to match PC and notebook coloring.</p> </li> <li> <p>• <b>Infographic:</b> Is perfect for presentations with the mixture of text and graphics due to its high color brightness and better color gradation to see the details clearly.</p> </li> <li> <p>• <b>Video:</b> Is suitable for playing videos in an environment where there is ambient light. Dynamic color details are preserved by BenQ enhancement technology.</p> </li> <li> <p>• <b>sRGB:</b> Maximizes the purity of RGB colors to provide true-to-life images regardless of brightness setting. It is most suitable for viewing photos taken with an sRGB compatible and properly calibrated camera, and for viewing PC graphic and drawing applications such as AutoCAD.</p> </li> <li> <p>• <b>3D:</b> Is appropriate for playing 3D images and 3D video clips.</p> </li> <li> <p>• <b>User 1/User 2:</b> Recalls the settings customized based on the current available picture modes. See <a href="#">Reference Mode on page 38</a>.</p> </li> </ul>





<b>Volume</b>	Adjusts the sound level.
<b>Light Mode</b>	See <a href="#">Setting the Light Mode on page 49</a> .
<b>Information</b>	<ul style="list-style-type: none"> <li>• <b>Native Resolution:</b> Shows the native resolution of the projector.</li> <li>• <b>Detected Resolution:</b> Shows the native resolution of the input signal.</li> <li>• <b>Source:</b> Shows the current signal source.</li> <li>• <b>Picture Mode:</b> Shows the selected mode in the <b>Picture</b> menu.</li> <li>• <b>Light Mode:</b> Shows the selected mode in the <b>Light Settings</b> menu.</li> <li>• <b>3D Format:</b> Shows the current 3D mode.</li> <li>• <b>Color System:</b> Shows input system format.</li> <li>• <b>Light Usage Time:</b> Shows the number of hours the light source has been used.</li> <li>• <b>Firmware Version:</b> Shows the firmware version of your projector.</li> <li>• <b>Service Code:</b> Shows the projector serial number.</li> </ul>
<b>Menu Type</b>	Switches to the <b>Advanced</b> OSD menu. See <a href="#">Using the menus on page 24</a> .

# Advanced menu











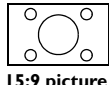

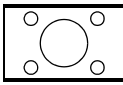
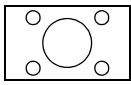
## Picture

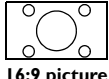
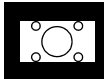

<b>Picture Mode</b>	<p>The projector is preset with several predefined picture modes so that you can choose one to suit your operating environment and input signal picture type.</p> <ul style="list-style-type: none"><li>• <b>Bright:</b> Maximizes the brightness of the projected image. This mode is suitable for environments where extra-high brightness is required, such as using the projector in well lit rooms.</li><li>• <b>Presentation:</b> Is designed for presentations. The brightness is emphasized in this mode to match PC and notebook coloring.</li><li>• <b>Infographic:</b> Is perfect for presentations with the mixture of text and graphics due to its high color brightness and better color gradation to see the details clearly.</li><li>• <b>Video:</b> Is suitable for playing videos in an environment where there is ambient light. Dynamic color details are preserved by BenQ enhancement technology.</li><li>• <b>sRGB:</b> Maximizes the purity of RGB colors to provide true-to-life images regardless of brightness setting. It is most suitable for viewing photos taken with an sRGB compatible and properly calibrated camera, and for viewing PC graphic and drawing applications such as AutoCAD.</li><li>• <b>3D:</b> Is appropriate for playing 3D images and 3D video clips.</li><li>• <b>User 1/User 2:</b> Recalls the settings customized based on the current available picture modes. See <a href="#">Reference Mode on page 38</a>.</li></ul>
<b>Reference Mode</b>	<p>There are 2 user-definable modes if the current available picture modes are not suitable for your need. You can use one of the picture modes (except the <b>User 1/User 2</b>) as a starting point and customize the settings.</p> <ol style="list-style-type: none"><li>1. Go to <b>Picture &gt; Picture Mode</b>.</li><li>2. Press ◀/▶ to select <b>User 1</b> or <b>User 2</b>.</li><li>3. Press ▼ to highlight <b>Reference Mode</b>, and press ◀/▶ to select a picture mode that is closest to your need.</li><li>4. Press ▼ to select a menu item to be changed and adjust the value. The adjustments define the selected user mode.</li></ol>
<b>Brightness</b>	<p>The higher the value, the brighter the image. Adjust this control so the black areas of the image appear just as black and that detail in the dark areas is visible.</p>
<b>Contrast</b>	<p>The higher the value, the greater the contrast. Use this to set the peak white level after you have previously adjusted the Brightness setting to suit your selected input and viewing environment.</p>
<b>Color</b>	<p>Lower setting produces less saturated colors. If the setting is too high, colors on the image will be overpowering, which makes the image unrealistic.</p>
<b>Tint</b>	<p>The higher the value, the more greenish the picture becomes. The lower the value, the more reddish the picture becomes.</p>
<b>Sharpness</b>	<p>The higher the value, the sharper the picture becomes.</p>

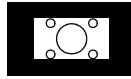

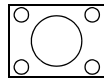
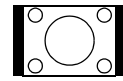
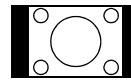
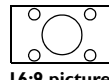
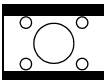
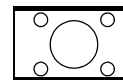
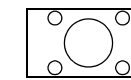
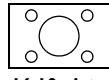
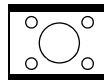
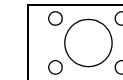
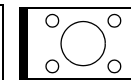
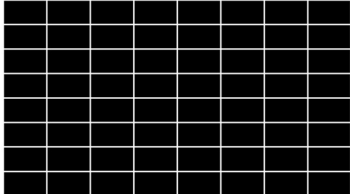

<p><b>Brilliant Color</b></p>	<p>This feature utilizes a new color-processing algorithm and system level enhancements to enable higher brightness while providing truer, more vibrant colors in picture. It enables a greater than 50% brightness increase in mid-tone images, which are common in video and natural scenes, so the projector reproduces images in realistic and true colors. If you prefer images with that quality, select <b>On</b>.</p> <p>When <b>Off</b> is selected, the <b>Color Temperature</b> function is not available.</p>
<p><b>Advanced Color Settings</b></p>	<p><b>Color Temperature</b></p> <p>There are several preset color temperature settings available. The available settings may vary according to the signal type selected.</p> <ul style="list-style-type: none"> <li>• <b>Normal:</b> Maintains normal colorings for white.</li> <li>• <b>Cool:</b> Makes images appear bluish white.</li> <li>• <b>Warm:</b> Makes images appear reddish white.</li> </ul> <p><b>Color Temperature Tuning</b></p> <p>You can also set a preferred color temperature by adjusting the following options.</p> <ul style="list-style-type: none"> <li>• <b>R Gain/G Gain/B Gain:</b> Adjusts the contrast levels of Red, Green, and Blue.</li> <li>• <b>R Offset/G Offset/B Offset:</b> Adjusts the brightness levels of Red, Green, and Blue.</li> </ul> <p><b>Color Management</b></p> <p>This function provides six sets (RGBCMY) of colors to be adjusted. When you select each color, you can independently adjust its range and saturation according to your preference.</p> <ul style="list-style-type: none"> <li>• <b>Primary Color:</b> Selects a color from among <b>R</b> (Red), <b>G</b> (Green), <b>B</b> (Blue), <b>C</b> (Cyan), <b>M</b> (Magenta), or <b>Y</b> (Yellow).</li> <li>• <b>Hue:</b> Hue is used for adjusting the color balance. Increase in the value will include colors consisted of more proportions of its adjacent colors in counterclockwise order. Decrease in the value will have effect in clockwise order. Please refer to the illustration for how the colors relate to each other</li> </ul> <div data-bbox="1098 1220 1453 1556" data-label="Diagram"> </div> <p>For example, if you select Red and set its value at 0, only pure red in the projected picture will be selected. Increasing its value will include red close to yellow while decreasing its value will include red close to magenta.</p> <li>• <b>Saturation:</b> Adjusts the values to your preference. Every adjustment made will reflect to the image immediately. For example, if you select Red and set its value at 0, only the saturation of pure red will be affected.</li> <p> <b>Saturation</b> is the amount of that color in a video picture. Lower settings produce less saturated colors; a setting of “0” removes that color from the image entirely. If the saturation is too high, that color will be overpowering and unrealistic.</p> <ul style="list-style-type: none"> <li>• <b>Gain:</b> Adjusts the values to your preference. The contrast level of the primary color you select will be affected. Every adjustment made will reflect to the image immediately.</li> </ul>

<p><b>Advanced Color Settings</b></p>	<p><b>Wall Color</b></p> <p>Corrects the projected picture's color when the projection surface such as a painted wall which may not be white, the Wall Color feature can help correct the projected picture's colors to prevent possible color difference between the source and projected pictures. There are several precalibrated colors to choose from: <b>Light Yellow, Pink, Light Green, Blue, and Blackboard.</b></p>
<p><b>LumiExpert</b></p>	<ul style="list-style-type: none"> <li>• <b>LumiExpert:</b> When this function is enabled, the projector actively detects the ambient light conditions and automatically adjusts balanced visual brightness to create an optimum viewing experience.</li> </ul>  <p>This function is not available when the <b>Picture Mode</b> is <b>Bright</b> or <b>3D</b>.</p> <ul style="list-style-type: none"> <li>• <b>LumiExpert Level:</b> Adjusts the gamma offset.</li> <li>• <b>Manual Calibration:</b> According to the ambient brightness, you can do the calibration manually. <ul style="list-style-type: none"> <li>• <b>Manual Calibration Status:</b> Shows the status of manual calibration.</li> <li>• <b>Calibrate:</b> Enact this item to start the calibration process.</li> <li>• <b>Reset Manual Calibration:</b> Resets the gamma offset to factory preset values.</li> </ul> </li> </ul>
<p><b>Reset Picture</b></p>	<p>Returns all of the adjustments you've made for the <b>Picture</b> menu to the factory preset values.</p>

# Display

<p><b>Aspect Ratio</b></p>	<p>There are several options to set the image's aspect ratio depending on your input signal source.</p> <ul style="list-style-type: none"> <li> <b>Auto:</b> Scales an image proportionally to fit the projector's native resolution in its horizontal or vertical width.           <div style="display: flex; align-items: center; margin-top: 10px;"> <div style="text-align: center;">  <p>15:9 picture</p> </div> <div style="margin: 0 10px;">→</div> <div style="display: flex; gap: 10px;">    </div> </div> <p style="font-size: small; text-align: right; margin-right: 20px;">(LX710/LX710D/ (LU710/LU710D/ (LH710/LH710D/ LX730/LX730D) LU930/LU930D) LH930/LH930D)</p> </li> <li> <b>Real:</b> Projects an image as its original resolution and resizes it to fit within the display area. For input signals with lower resolutions, the projected image will be displayed in its original size.           <div style="display: flex; align-items: center; margin-top: 10px;"> <div style="text-align: center;">  <p>4:3 picture</p> </div> <div style="margin: 0 10px;">→</div> <div style="display: flex; gap: 10px;">    </div> </div> <div style="display: flex; align-items: center; margin-top: 10px;"> <div style="text-align: center;">  <p>16:9 picture</p> </div> <div style="margin: 0 10px;">→</div> <div style="display: flex; gap: 10px;">    </div> </div> </li> <li> <b>4:3:</b> Scales an image so that it is displayed in the center of the screen with a 4:3 aspect ratio.           <div style="display: flex; align-items: center; margin-top: 10px;"> <div style="text-align: center;">  <p>4:3 picture</p> </div> <div style="margin: 0 10px;">→</div> <div style="display: flex; gap: 10px;">    </div> </div> </li> <li> <b>16:9:</b> Scales an image so that it is displayed in the center of the screen with a 16:9 aspect ratio.           <div style="display: flex; align-items: center; margin-top: 10px;"> <div style="text-align: center;">  <p>16:9 picture</p> </div> <div style="margin: 0 10px;">→</div> <div style="display: flex; gap: 10px;">    </div> </div> </li> <li> <b>16:10:</b> Scales an image so that it is displayed in the center of the screen with a 16:10 aspect ratio.           <div style="display: flex; align-items: center; margin-top: 10px;"> <div style="text-align: center;">  <p>16:10 picture</p> </div> <div style="margin: 0 10px;">→</div> <div style="display: flex; gap: 10px;">    </div> </div> </li> </ul>
<p><b>Keystone</b></p>	<p>This function provides manual 2D keystone adjustment and auto vertical keystone adjustment. See <a href="#">Correcting keystone on page 19</a>.</p>
<p><b>Corner Fit</b></p>	<p>See <a href="#">Adjusting Corner Fit on page 20</a>.</p>
<p><b>Test Pattern</b></p>	<p>Built-in images for checking if the projected image is free from distortion.</p> <div style="text-align: right; margin-top: 20px;">  </div>
<p><b>PC &amp; Component YPbPr Tuning</b></p>	<ul style="list-style-type: none"> <li> <b>Phase:</b> Adjusts the clock phase to reduce image distortion.           </li> <li> <b>H. Size:</b> Adjusts the horizontal width of the image.           <div style="text-align: right; margin-top: 10px;">  </div> </li> </ul>
<p><b>Position</b></p>	<p>Displays the position adjustment page. To move the projected image, use the directional arrow keys. This function is only available when a PC signal (analog RGB) is selected.</p>

<p><b>3D</b></p>	<p>This projector features a 3D function which enables you to enjoy the 3D movies, videos, and sporting events in a more realistic way by presenting the depth of the images. You need to wear a pair of 3D glasses to view the 3D images.</p> <ul style="list-style-type: none"> <li>• <b>3D Mode:</b> The default setting is <b>Off</b>. If you want the projector to automatically choose an appropriate 3D format when detecting 3D contents, select <b>Auto</b>. If the projector cannot recognize the 3D format, press ▲/▼ to choose a 3D mode from among <b>Top Bottom</b>, <b>Frame Sequential</b>, <b>Frame Packing</b> and <b>Side by Side</b>.</li> </ul> <p> When 3D function is activated:</p> <ul style="list-style-type: none"> <li>• The brightness level of the projected image will decrease.</li> <li>• The following settings cannot be adjusted: <b>Picture Mode</b>, <b>Reference Mode</b>.</li> <li>• The <b>Keystone</b> can only be adjusted within limited degrees.</li> <li>• <b>3D Sync Invert:</b> When you discover the inversion of the image depth, enable this function to correct the problem.</li> <li>• <b>Apply 3D Settings:</b> After the 3D settings are saved, you can decide if you would like to apply them by choosing a set of 3D settings that you have saved. Once applied, the projector will automatically play the incoming 3D contents if it matches the 3D settings saved.</li> </ul> <p> Only the set(s) of 3D settings with memorized data is available.</p> <ul style="list-style-type: none"> <li>• <b>Save 3D Settings:</b> When you have successfully displayed the 3D contents after making the appropriate adjustments, you can enable this function and choose a set of 3D settings to memorize current 3D settings.</li> </ul>
<p><b>HDMI Format</b></p>	<p>Selects a suitable color format to optimize display quality.</p> <ul style="list-style-type: none"> <li>• <b>Auto:</b> Automatically selects a suitable color space and gray level for the incoming HDMI signal.</li> <li>• <b>RGB Limited:</b> Utilizes the Limited range RGB 16-235.</li> <li>• <b>RGB Full:</b> Utilizes the Full range RGB 0-255.</li> <li>• <b>YUV Limited:</b> Utilizes the Limited range YUV 16-235.</li> <li>• <b>YUV Full:</b> Utilizes the Full range YUV 0-255.</li> </ul>

<b>Image Resizing</b>	<p><b>Digital Zoom</b></p> <p>Magnifies or reduces the projected image size.</p> <ol style="list-style-type: none"> <li>1. After the adjustment bar displays, press ▲/▼ repeatedly to reduce or magnify the image to a desired size.</li> <li>2. Press <b>OK</b> to enter panning mode.</li> <li>3. Press the directional arrows (▲, ▼, ◀, ▶) on the projector or remote control to navigate the picture.</li> </ol>  <p>The picture can only be navigated after it is magnified. You can further magnify the picture while searching for details.</p>
	<p><b>Digital Shrink &amp; Shift</b></p> <p>Shrinks and/or shifts the projected image.</p> <ol style="list-style-type: none"> <li>1. After the adjustment bar displays, press ◀/▶ repeatedly to shrink or magnify the picture to a desired size.</li> <li>2. Press <b>OK</b> to activate digital shift function.</li> <li>3. After digital shift function is activated, press the directional arrows (▲, ▼, ◀, ▶) to shift the image.</li> <li>4. Press <b>AUTO</b> to restore the picture to its original size.</li> </ol>  <p>The picture can only be shifted after it shrank.</p>
	<p><b>Blanking</b></p> <p>Blanks some parts of the projected image.</p> <ol style="list-style-type: none"> <li>1. Select the <b>Modes of Adjustment</b> first by pressing ◀/▶.</li> <li>2. Press ▲/▼ to highlight the area you want to adjust and press ◀/▶ to adjust its range.</li> </ol>  <p>Enacting the <b>Reset All Blanking Settings</b> function will return all items in the <b>Blanking</b> menu to the factory preset values. Pressing <b>AUTO</b> clears the values of selected item (excluding <b>Modes of Adjustment</b>).</p>
<b>Digital Lens Shift</b>	<p>After the <b>Digital Lens Shift</b> page displays, press ▲/▼ to shift the projected image.</p>  <p>This function is not available in the following situations: <b>Picture Mode</b> is <b>3D</b>; <b>Display Resolution Switch</b> is <b>WUXGA</b>.</p>
<b>Reset Display</b>	<p>Returns all of the adjustments you've made for the <b>Display</b> menu to the factory preset values.</p>

## Network



<b>Wired LAN</b>	See <a href="#">Controlling the projector through a Wired LAN environment on page 27</a> .
------------------	--

<b>AMX Device Discovery</b>	When this function is <b>On</b> , the projector can be detected by AMX controller.
<b>MAC Address (Wired)</b>	Displays the mac address for this projector.

## Settings

<b>Projector Installation</b>	The projector can be installed on a ceiling or behind a screen, or with one or more mirrors. See <a href="#">Choosing a location on page 11</a> .
<b>Remote Receiver</b>	Allows you to enable all the remote receivers or one specific remote receiver on the projector.
<b>Auto Source Search</b>	Allows the projector to automatically search for a signal.
<b>Auto Sync</b>	<ul style="list-style-type: none"> <li>• <b>On</b>: Allows the projector to automatically determines the best picture timings for the displayed image when PC signal (analog RGB) is selected and <b>AUTO</b> is pressed.</li> <li>• <b>Off</b>: The projector will not respond when <b>AUTO</b> is pressed.</li> </ul>
<b>Dynamic Dimming</b>	Allows the projector to automatically detect the video content and enhance contrast during dark scenes.
<b>Light Settings</b>	<ul style="list-style-type: none"> <li>• <b>Light Mode</b>: See <a href="#">Setting the Light Mode on page 49</a>.</li> <li>• <b>Custom Brightness</b>: Only available when <b>Light Mode</b> is <b>Custom</b>.</li> <li>• <b>Light Usage Time</b>: Displays the number of hours the light source has been used.</li> </ul>





<p><b>Operation Settings</b></p>	<p><b>Blank Timer</b></p> <p>Sets the image blank time when there is no action taken on the blank screen, once elapsed the image will return to the screen. If the preset time spans are not suitable for your need, select <b>Disable</b>. No matter <b>Blank Timer</b> is activated or not, you can press most of the keys on the projector or remote control to restore the picture.</p>
	<p><b>Reminder Message</b></p> <p>Sets the reminder messages on or off.</p>
	<p><b>High Altitude Mode</b></p> <p>We recommend you use the <b>High Altitude Mode</b> when your environment is between 1500 m –3000 m above sea level, and ambient temperature is between 0°C–30°C.</p> <p>Operation under "<b>High Altitude Mode</b>" may cause a higher decibel operating noise level because of increased fan speed necessary to improve overall system cooling and performance.</p> <p>If you use this projector under other extreme conditions excluding the above, it may display auto shut-down symptoms, which is designed to protect your projector from over-heating. In cases like this, you should switch to High Altitude mode to solve these symptoms. However, this is not to state that this projector can operate under any and all harsh or extreme conditions.</p> <p></p> <p>Do not use the <b>High Altitude Mode</b> if your altitude is between 0 m and 1500 m and ambient temperature is between 0°C and 35°C. The projector will be over cooled, if you turn the mode on under such a condition.</p>
	<p><b>Power On/Off Settings</b></p> <ul style="list-style-type: none"> <li>• <b>Direct Power On:</b> Allows the projector to turn on automatically once the power is fed through the power cord.</li> <li>• <b>Signal Power On:</b> Sets whether to turn the projector directly on without pressing  <b>POWER</b> or  <b>ON</b> when the projector is in standby mode and detects a VGA signal or a HDMI signal with 5V power.</li> <li>• <b>Auto Power Off:</b> Allows the projector to turn off automatically if no input signal is detected after a set period of time to prevent unnecessary waste of light source life.</li> <li>• <b>Power Off Timer:</b> Sets the auto-shutdown timer.</li> </ul>
	<p><b>I2V Trigger</b></p> <p>There is one I2V trigger that works independently according to your needs for installation scenarios.</p> <ul style="list-style-type: none"> <li>• <b>Off:</b> If this is selected, the projector will not send electronic signal out when it is turned on.</li> <li>• <b>On:</b> The projector will send a low to high electronic signal out when it is turned on, a high to low signal out when it is turned off.</li> </ul>
<p><b>Security Settings</b></p>	<p>See <a href="#">Utilizing the password function on page 25</a>.</p>

<b>Baud Rate</b>	Selects a baud rate that is identical with your computer's so that you can connect the projector using a suitable RS-232 cable and update or download the projector's firmware. This function is intended for qualified service personnel.
<b>HDMI Equalizer</b>	Adjusts the equalizer gain settings for an HDMI signal. The higher the setting, the stronger the gain value. If there are more than one HDMI port on the projector, select the HDMI port first before adjusting the value.
<b>USB Power Switch</b>	Disables or enables "Type A connector" 5V power output. To enable this function, select <b>On</b> .
<b>Reset Settings</b>	Returns all of the adjustments you've made for the <b>Settings</b> menu to the factory preset values.

## System

<b>Language</b>	Sets the language for the On-Screen Display (OSD) menus.
<b>Standby Settings</b>	<ul style="list-style-type: none"> <li>• <b>Standby Mode</b> <ul style="list-style-type: none"> <li>• <b>Eco:</b> The projector maintains at normal standby mode with less than 0.5W power consumption.</li> <li>• <b>Network:</b> The projector maintains at network standby mode with less than 2W power consumption.</li> <li>• <b>Normal:</b> Allows the projector to provide network, monitor out and audio pass through functions in standby mode.</li> </ul> </li> <li>• <b>Auto Disable Network Standby Mode:</b> Allows the projector to disable the network function after a set period of time after it enters standby mode. For instance, if 20 min is selected, the projector is able to provide the network function for 20 minutes after it enters standby mode. When 20 minutes is up, the projector enters normal standby mode.</li> <li>• <b>Audio Pass Through:</b> The projector can play sound when it is in standby mode and the corresponding jacks are correctly connected to devices. Press ◀/▶ to choose the source that you wish to use. See <a href="#">Connection on page 21</a> for how to make the connection.</li> </ul>
<b>Background Settings</b>	<ul style="list-style-type: none"> <li>• <b>Background:</b> Sets the background color for the projector.</li> <li>• <b>Splash Screen:</b> Allows you to select which logo screen will be displayed during projector start-up.</li> </ul>
<b>Menu Settings</b>	<ul style="list-style-type: none"> <li>• <b>Menu Type:</b> Switches to the <b>Basic</b> OSD menu.</li> <li>• <b>Menu Display Time:</b> Sets the length of time the OSD will remain active after your last key press.</li> </ul>
<b>Audio Settings</b>	<ul style="list-style-type: none"> <li>• <b>Mute:</b> Temporarily turns off the sound.</li> <li>• <b>Volume:</b> Adjusts the sound level.</li> <li>• <b>Power On/Off Ring Tone:</b> Turns on or off the ring tone when the projector is in startup and shutdown process.</li> </ul>  <p>The only way to change <b>Power On/Off Ring Tone</b> is setting <b>On</b> or <b>Off</b> here. Setting the sound mute or changing the sound level will not affect the <b>Power On/Off Ring Tone</b>.</p>

<p><b>Closed Caption</b></p>	<ul style="list-style-type: none"> <li>• <b>Closed Caption Enable:</b> Activates the function by selecting <b>On</b> when the selected input signal carries closed captions.</li> </ul>  <p>Captions: An on-screen display of the dialogue, narration, and sound effects of TV programs and videos that are closed captioned (usually marked as "CC" in TV listings).</p> <ul style="list-style-type: none"> <li>• <b>Caption Version:</b> Selects a preferred closed captioning mode. To view captions, select <b>CC1</b>, <b>CC2</b>, <b>CC3</b>, or <b>CC4</b> (<b>CC1</b> displays captions in the primary language in your area).</li> </ul>
<p><b>Display Resolution Switch (LU710/LU710D /LU930/LU930D)</b></p>	<p>Select the native resolution of this projector between <b>WUXGA</b> and <b>1080P</b>.</p>
<p><b>Factory Default</b></p>	<p>Returns all settings to the factory preset values.</p>  <p>The following settings will still remain: <b>2D Keystone</b>, <b>Auto Vertical Keystone</b>, <b>Corner Fit</b>, <b>Projector Installation</b>, <b>Light Usage Time High Altitude Mode</b>, <b>Security Settings</b>, <b>Baud Rate</b>, <b>LumiExpert</b>, <b>Corner Fit</b>, <b>Digital Shrink &amp; Shift</b>, <b>Digital Lens Shift</b>, <b>Network</b>, <b>HDMI Equalizer</b>, <b>Display Resolution Switch</b>, <b>Dynamic Dimming</b>, <b>Custom Brightness</b>.</p>
<p><b>Reset System</b></p>	<p>Returns all of the adjustments you've made for the <b>System</b> menu to the factory preset values.</p>

## Information

<p><b>Information</b></p>	<ul style="list-style-type: none"> <li>• <b>Native Resolution:</b> Shows the native resolution of the projector.</li> <li>• <b>Detected Resolution:</b> Shows the native resolution of the input signal.</li> <li>• <b>Source:</b> Shows the current signal source.</li> <li>• <b>Picture Mode:</b> Shows the selected mode in the <b>Picture</b> menu.</li> <li>• <b>Light Mode:</b> Shows the selected mode in the <b>Light Settings</b> menu.</li> <li>• <b>3D Format:</b> Shows the current 3D mode.</li> <li>• <b>Color System:</b> Shows input system format.</li> <li>• <b>Light Usage Time:</b> Shows the number of hours the light source has been used.</li> <li>• <b>Firmware Version:</b> Shows the firmware version of your projector.</li> </ul>
---------------------------	--

# Maintenance

## Care of the projector

### Cleaning the lens

Clean the lens whenever you notice dirt or dust on the surface. Please be sure to turn off the projector and let it cool down completely before cleaning the lens.

- Use a canister of compressed air to remove dust.
- If there is dirt or smears, use lens-cleaning paper or moisten a soft cloth with lens cleaner and gently wipe the lens surface.
- Never use any type of abrasive pad, alkaline/acid cleaner, scouring powder, or volatile solvent, such as alcohol, benzene, thinner or insecticide. Using such materials or maintaining prolonged contact with rubber or vinyl materials may result in damage to the projector surface and cabinet material.

### Cleaning the projector case

Before you clean the case, turn the projector off using the proper shutdown procedure as described in [Shutting down the projector on page 30](#) and unplug the power cord.

- To remove dirt or dust, wipe the case with a soft, lint-free cloth.
- To remove stubborn dirt or stains, moisten a soft cloth with water and a neutral pH detergent. Then wipe the case.



Never use wax, alcohol, benzene, thinner or other chemical detergents. These can damage the case.

### Storing the projector

If you need to store the projector for an extended time, please follow the instructions below:

- Make sure the temperature and humidity of the storage area are within the recommended range for the projector. Please refer to [Specifications on page 52](#) or consult your dealer about the range.
- Retract the adjuster feet.
- Remove the battery from the remote control.
- Pack the projector in its original packing or equivalent.

### Transporting the projector

It is recommended that you ship the projector with its original packing or equivalent.

## Light source information

### Getting to know the light source hour

When the projector is in operation, the duration (in hours) of light source usage is automatically calculated by the built-in timer. The method of calculating the equivalent light source hour is as follows:

Light source Usage Time = (hours used in **Normal** mode) + (hours used in **Economic** mode) + (hours used in **Dimming** mode) + (hours used in **Custom** mode)

Total (equivalent) light source hour = 1.0 x (hours used in **Normal** mode) + 1.0 x (hours used in **Economic** mode) + 1.0 x (hours used in **Dimming** mode) + 1.0 x (hours used in **Custom** mode)

To obtain the light source hour information:

1. Go to **Advanced Menu - Settings > Light Settings** and press **OK**. The **Light Settings** page appears.
2. Press **▼** to select **Light Usage Time** and press **OK**. The **Light Usage Time** information is displayed.

You can also get the light source hour information on the **Information** menu.

### Extending light source life

#### • Setting the **Light Mode**

Go to **Advanced Menu - Settings > Light Settings > Light Mode** and select a suitable light source power from among the provided modes.

Setting the projector in **Economic, Dimming or Custom** mode extends light source life.

Light Source mode	Description
<b>Normal</b>	Provides full light source brightness
<b>Economic</b>	Lowers brightness to extend the light source life and decreases the fan noise
<b>Dimming</b>	Lowers brightness to offer a longer light source life
<b>Custom</b>	Enables the light source brightness adjustment bar so that you can adjust the setting to your liking

#### • Setting **Auto Power Off**

























































This function allows the projector to turn off automatically if no input signal is detected after a set period of time to prevent unnecessary waste of light source life.









To set **Auto Power Off**, go to **Advanced Menu - Settings > Operation Settings > Power On/Off Settings > Auto Power Off** and press **◀/▶**.



- The apparent brightness of the projected image will vary depending on the ambient lighting conditions, selected input signal contrast/brightness settings, and is directly proportional to projection distance.
- The light source brightness will decline over time and may vary within the light source manufacturers specifications. This is normal and expected behavior.

## Indicators

Light			Status & Description
POWER	TEMP	LIGHT	
<b>Power events</b>			
			Stand-by mode
			Powering up
			Normal operation
			Normal power-down cooling
			Download
			CW start fail
			Phosphor wheel start fail
			Burn-in ON
			Burn-in OFF
<b>Light source events</b>			
			Light source life exhausted
			Light source error in normal operation
			Light source is not lit up
<b>Thermal events</b>			
			Fan 1 error (the actual fan speed is outside the desired speed)
			Fan 2 error (the actual fan speed is outside the desired speed)
			Fan 3 error (the actual fan speed is outside the desired speed)
			Fan 4 error (the actual fan speed is outside the desired speed)
			Fan 5 error (the actual fan speed is outside the desired speed)
			Fan 6 error (the actual fan speed is outside the desired speed)
			Temperature 1 error (over limited temperature)

	 : <b>Off</b>	 : Orange On  : Orange Flashing	 : Green On  : Green Flashing	 : Red On  : Red Flashing
---	--	--	--	--

# Troubleshooting

## ? The projector does not turn on.

Cause	Remedy
There is no power from the power cord.	Plug the power cord into the AC power jack on the projector, and plug the power cord into the power outlet. If the power outlet has a switch, make sure that it is switched on.
Attempting to turn the projector on again during the cooling process.	Wait until the cooling down process has completed.

## ? No picture

Cause	Remedy
The video source is not turned on or connected correctly.	Turn the video source on and check that the signal cable is connected correctly.
The projector is not correctly connected to the input signal device.	Check the connection.
The input signal has not been correctly selected.	Select the correct input signal with the <b>SOURCE</b> key.
The lens cover is still closed.	Open the lens cover.

## ? Blurred image

Cause	Remedy
The projection lens is not correctly focused.	Adjust the focus of the lens using the focus ring.
The projector and the screen are not aligned properly.	Adjust the projection angle and direction as well as the height of the projector if necessary.
The lens cover is still closed.	Open the lens cover.

## ? Remote control does not work.

Cause	Remedy
The batteries are out of power.	Replace both of the batteries with new ones.
There is an obstacle between the remote control and the projector.	Remove the obstacle.
You are too far away from the projector.	Stand within 8 meters (26 feet) of the projector.

## ? The password is incorrect.

Cause	Remedy
You do not remember the password.	See <a href="#">Entering the password recall procedure on page 26.</a>

# Specifications

## Projector specifications



All specifications are subject to change without notice.

### Optical

#### Resolution

**LX710/LX710D/LX730/LX730D:** 1024 x 768 XGA  
**LU710/LU710D/LU930/LU930D:** 1920 x 1200 WUXGA  
**LH710/LH710D/LH930/LH930D:** 1920 x 1080 1080p

#### Display system

1-CHIP DMD

#### Lens

**LX710/LX710D:** F = 2.59~2.87, f = 16.88~21.88 mm  
**LX730/LX730D:** F = 2.45~3.07, f = 15.75~25.1 mm  
**LU710/LU710D:** F = 1.94~2.07, f = 11.9~15.5 mm  
**LH710/LH710D:** F = 1.94~2.12, f = 11.9~15.5 mm  
**LU930/LU930D/LH930/LH930D:**  
F = 1.81~2.1, f = 14.3~22.9 mm

#### Clear focus range

**LX710/LX710D:**  
1.84–5.52m@Wide, 2.40–7.2m@Tele  
**LX730/LX730D:**  
1.72–4.30m@Wide, 2.74–6.86m@Tele  
**LU710/LU710D:**  
1.46–4.87m@Wide, 1.89–6.29@Tele  
**LU930/LU930D:**  
1.76–5.86m@Wide, 2.82–9.39m@Tele  
**LH710/LH710D:**  
1.50–5.00m@Wide, 1.94–6.46@Tele  
**LH930/LH930D:**  
1.81–6.02 m@Wide, 2.90–9.65m@Tele

#### Light source

Laser

### Electrical

#### Power supply / Power consumption

**LX710/LX710D/LU710/LU710D/LH710/LH710D:**  
AC100–240V, 3.8A, 50–60 Hz (Automatic) /  
392 W (Max); < 0.5 W (Standby)  
**LX730/LX730D/LU930/LU930D/LH930/LH930D:**  
AC100–240V, 5.2A, 50–60 Hz (Automatic) /  
475 W (Max); < 0.5 W (Standby)

### Mechanical

#### Weight

6.3 Kg (13.0 lbs)

### Output terminals

#### RGB output

D-Sub 15-pin (female) x 1

#### Speaker

13 watt x 2

#### Audio signal output

PC audio jack x 1

### Control

#### USB

Type-A x 1 (5V/1.5A)

#### RS-232 serial control

9 pin x 1

#### LAN control

RJ45 x 1

#### 12V trigger x 1

#### IR receiver x 2

### Input terminals

#### Computer input

##### RGB input

D-Sub 15-pin (female) x 1

#### Video signal input

##### VIDEO

RCA jack x 1

##### SD/HDTV signal input

Analog - Component RCA RGB x 1

Digital - HDMI x 2

#### Audio signal input

PC audio jack x 1

RCA audio jack (L/R) x 1

### Environmental Requirements

#### Operating temperature

0°C–40°C at sea level

#### Operating relative humidity

10%–90% (without condensation)

#### Operating altitude

0–1499 m at 0°C–35°C

1500–3000 m at 0°C–30°C (with

High Altitude Mode on)

#### Storage temperature

-20°C–60°C at sea level

#### Storage humidity

10%–90% RH (without condensation)

#### Storage altitude

30°C@ 0~12,200m above sea level

#### Transporting

Original packing or equivalent is recommended

#### Repairing

Please visit below website and choose your country to find your service contact window.

<http://www.benq.com/welcome>



# Dimensions

LX710/LX710D/LU710/  
LU710D/LH710/LH710D/LX730/LX730D

416 mm (W) x 166 mm (H) x 312 mm (D)

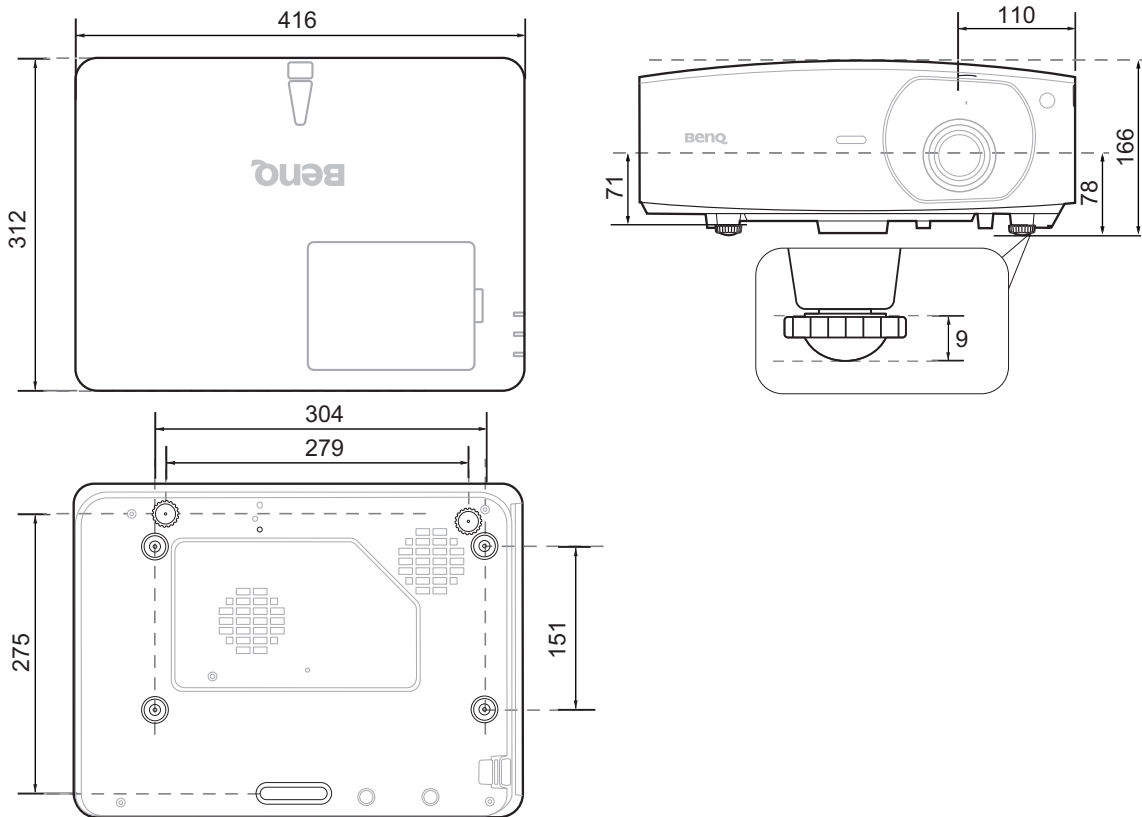

LU930/LU930D/LH930/  
LH930D

416 mm (W) x 166 mm (H) x 351 mm (D)

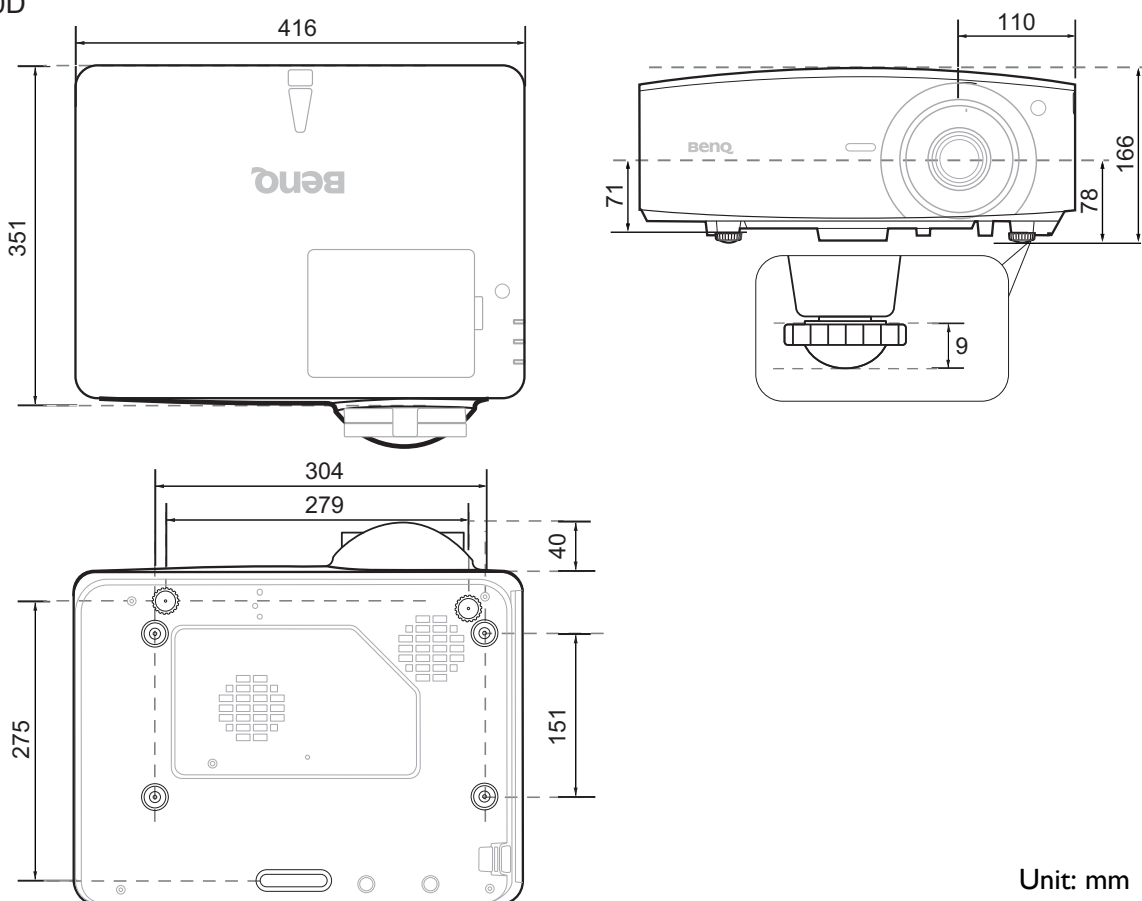

Unit: mm

# Timing chart

## Supported timing for PC input

Resolution	Mode	Vertical Frequency (Hz)	Horizontal Frequency (kHz)	Pixel Frequency (MHz)	Supported 3D format		
					Frame Sequential	Top Bottom	Side by Side
720 x 400	720 x 400_70	70.087	31.469	28.3221			
640 x 480	VGA_60	59.940	31.469	25.175	Supported	Supported	Supported
	VGA_72	72.809	37.861	31.500			
	VGA_75	75.000	37.500	31.500			
	VGA_85	85.008	43.269	36.000			
800 x 600	SVGA_60	60.317	37.879	40.000	Supported	Supported	Supported
	SVGA_72	72.188	48.077	50.000			
	SVGA_75	75.000	46.875	49.500			
	SVGA_85	85.061	53.674	56.250			
	SVGA_120 (Reduce Blanking)	119.854	77.425	83.000	Supported		
1024 x 768	XGA_60	60.004	48.363	65.000	Supported	Supported	Supported
	XGA_70	70.069	56.476	75.000			
	XGA_75	75.029	60.023	78.750			
	XGA_85	84.997	68.667	94.500			
	XGA_120 (Reduce Blanking)	119.989	97.551	115.5	Supported		
1152 x 864	1152 x 864_75	75	67.5	108			
1024 x 576	BenQ Notebook_timing	60.0	35.820	46.966			
1024 x 600	BenQ Notebook_timing	64.995	41.467	51.419			
1280 x 720	1280 x 720_60	60	45.000	74.250	Supported	Supported	Supported
1280 x 768	1280 x 768_60	59.87	47.776	79.5	Supported	Supported	Supported
1280 x 800	WXGA_60	59.810	49.702	83.500	Supported	Supported	Supported
	WXGA_75	74.934	62.795	106.500			
	WXGA_85	84.880	71.554	122.500			
	WXGA_120 (Reduce Blanking)	119.909	101.563	146.25	Supported		
1280 x 1024	SXGA_60	60.020	63.981	108.000		Supported	Supported
	SXGA_75	75.025	79.976	135.000			
	SXGA_85	85.024	91.146	157.500			
1280 x 960	1280 x 960_60	60.000	60.000	108.000		Supported	Supported
	1280 x 960_85	85.002	85.938	148.500			
1360 x 768	1360 x 768_60	60.015	47.712	85.5		Supported	Supported
1440 x 900	WXGA+_60	59.887	55.935	106.500		Supported	Supported
1400 x 1050	SXGA+_60	59.978	65.317	121.750		Supported	
1600 x 1200	UXGA	60.000	75.000	162.000		Supported	Supported
1680 x 1050	1680 x 1050_60	59.954	65.290	146.250		Supported	Supported
640 x 480@67Hz	MAC13	66.667	35.000	30.240			
832 x 624@75Hz	MAC16	74.546	49.722	57.280			
1024 x 768@75Hz	MAC19	74.93	60.241	80.000			
1152 x 870@75Hz	MAC21	75.060	68.680	100.000			



The timings showing above may not be supported due to EDID file and VGA graphic card limitations. It is possible that some timings cannot be chosen.

## Supported timing for HDMI (HDCP) input

- PC timings

Resolution	Mode	Vertical Frequency (Hz)	Horizontal Frequency (kHz)	Pixel Frequency (MHz)	Supported 3D format		
					Frame Sequential	Top Bottom	Side by Side
640 x 480	VGA_60	59.940	31.469	25.175	Supported	Supported	Supported
	VGA_72	72.809	37.861	31.500			
	VGA_75	75.000	37.500	31.500			
	VGA_85	85.008	43.269	36.000			
720 x 400	720 x 400_70	70.087	31.469	28.3221			
800 x 600	SVGA_60	60.317	37.879	40.000	Supported	Supported	Supported
	SVGA_72	72.188	48.077	50.000			
	SVGA_75	75.000	46.875	49.500			
	SVGA_85	85.061	53.674	56.250			
1024 x 768	SVGA_120 (Reduce Blanking)	119.854	77.425	83.000	Supported		
	XGA_60	60.004	48.363	65.000	Supported	Supported	Supported
	XGA_70	70.069	56.476	75.000			
	XGA_75	75.029	60.023	78.750			
1152 x 864	XGA_85	84.997	68.667	94.500			
	XGA_120 (Reduce Blanking)	119.989	97.551	115.5	Supported		
1280 x 768	1152 x 864_75	75	67.5	108			
1024 x 576	1280 x 768_60	59.87	47.776	79.5			
1024 x 600	BenQ Notebook Timing	60.00	35.820	46.996			
1280 x 720	BenQ Notebook Timing	64.995	41.467	51.419			
1280 x 768	1280 x 720_60	60	45.000	74.250	Supported	Supported	Supported
1280 x 800	1280 x 768_60	59.870	47.776	79.5	Supported	Supported	Supported
	WXGA_60	59.810	49.702	83.500	Supported	Supported	Supported
	WXGA_75	74.934	62.795	106.500			
	WXGA_85	84.880	71.554	122.500			
1280 x 1024	WXGA_120 (Reduce Blanking)	119.909	101.563	146.25	Supported		
	SXGA_60	60.020	63.981	108.000		Supported	Supported
	SXGA_75	75.025	79.976	135.000			
1280 x 960	SXGA_85	85.024	91.146	157.500			
	1280 x 960_60	60.000	60.000	108		Supported	Supported
1360 x 768	1280 x 960_85	85.002	85.938	148.500			
1440 x 900	1360 x 768_60	60.015	47.712	85.500		Supported	Supported
1400 x 1050	WXGA+_60	59.887	55.935	106.500		Supported	Supported
1600 x 1200	SXGA+_60	59.978	65.317	121.750		Supported	Supported
1680 x 1050	UXGA	60.000	75.000	162.000		Supported	Supported
640 x 480@67Hz	1680 x 1050_60	59.954	65.290	146.250		Supported	Supported
832 x 624@75Hz	MAC13	66.667	35.000	30.240			
1024 x 768@75Hz	MAC16	74.546	49.722	57.280			
1152 x 870@75Hz	MAC19	75.020	60.241	80.000			
1920 x 1080@60Hz	MAC21	75.06	68.68	100.00			
1920 x 1200@60Hz	1920 x 1080_60	60	67.5	148.5		Supported	Supported
	1920 x 1200_60 (Reduce Blanking)	59.950	74.038	154.0000		Supported	Supported



The timings showing above may not be supported due to EDID file and VGA graphic card limitations. It is possible that some timings cannot be chosen.

• Video timings

Timing	Resolution	Vertical Frequency (Hz)	Horizontal Frequency (kHz)	Pixel Frequency (MHz)	Supported 3D format			
					Frame Sequential	Frame Packing	Top Bottom	Side by Side
480i	720 x 480	59.94	15.73	27	Supported			
480p	720 x 480	59.94	31.47	27	Supported			
576i	720 x 576	50	15.63	27				
576p	720 x 576	50	31.25	27				
720/50p	1280 x 720	50	37.5	74.25		Supported	Supported	Supported
720/60p	1280 x 720	60	45.00	74.25	Supported	Supported	Supported	Supported
1080/24P	1920 x 1080	24	27	74.25		Supported	Supported	Supported
1080/25P	1920 x 1080	25	28.13	74.25				
1080/30P	1920 x 1080	30	33.75	74.25				
1080/50i	1920 x 1080	50	28.13	74.25				Supported
1080/60i	1920 x 1080	60	33.75	74.25				Supported
1080/50P	1920 x 1080	50	56.25	148.5			Supported	Supported
1080/60P	1920 x 1080	60	67.5	148.5			Supported	Supported

Supported timing for Component-YPbPr input

Timing	Resolution	Vertical Frequency (Hz)	Horizontal Frequency (kHz)	Pixel Frequency (MHz)	Supported 3D format
					Frame Sequential
480i	720 x 480	59.94	15.73	13.5	Supported
480p	720 x 480	59.94	31.47	27	Supported
576i	720 x 576	50	15.63	13.5	
576p	720 x 576	50	31.25	27	
720/50p	1280 x 720	50	37.5	74.25	
720/60p	1280 x 720	60	45.00	74.25	Supported
1080/50i	1920 x 1080	50	28.13	74.25	
1080/60i	1920 x 1080	60	33.75	74.25	
1080/24P	1920 x 1080	24	27	74.25	
1080/25P	1920 x 1080	25	28.13	74.25	
1080/30P	1920 x 1080	30	33.75	74.25	
1080/50P	1920 x 1080	50	56.25	148.5	
1080/60P	1920 x 1080	60	67.5	148.5	



Displaying a 1080i(1125i)@60Hz or 1080i(1125i)@50Hz signal may result in slight image vibration.

Supported timing for Video input

Video mode	Horizontal Frequency (kHz)	Vertical Frequency (Hz)	Color sub-carrier Frequency (MHz)	Supported 3D format
				Frame Sequential
NTSC	15.73	60	3.58	Supported
PAL	15.63	50	4.43	
SECAM	15.63	50	4.25 or 4.41	
PAL-M	15.73	60	3.58	
PAL-N	15.63	50	3.58	
PAL-60	15.73	60	4.43	
NTSC4.43	15.73	60	4.43	