



Because it matters

BenQ-PointWrite 2.0 Dual Screen Setup

Compatible with PW40U/PW30U

Maggie Chen

2019/04

Dual Screen set-up step



- ① Download Dual screen driver from BenQ website
- ② Surface Setup
- ③ Camera Installation on Projector(please refer to corresponding PointWrite User Manual)
- ④ Projector Alignment
- ⑤ Connection Setup
- ⑥ Display Setting for master screen/extend screen
- ⑦ Camera Configuration setting
- ⑧ Alignment View check and Calibration
- ⑨ QWrite Dual Screen Mode Setting
- ⑩ Start for dual screen projection

Where to download BenQ-PointWrite 2.0 Dual Screen driver



- ① Go to BenQ Display Website <https://business-display.benq.com/en/index.html>
Find Product →Projector→Accessory
- ② Search PW40U or PW30U
Go to "Download Page"to download PointWrite 2.0 Dual screen driver

Surface condition



- You can install the interactive projector so the projected image falls on a wall surface or an existing dry-erase board. Ensure you choose a surface that is smooth, flat and has no protruding objects.

Surface even tolerance

2mm

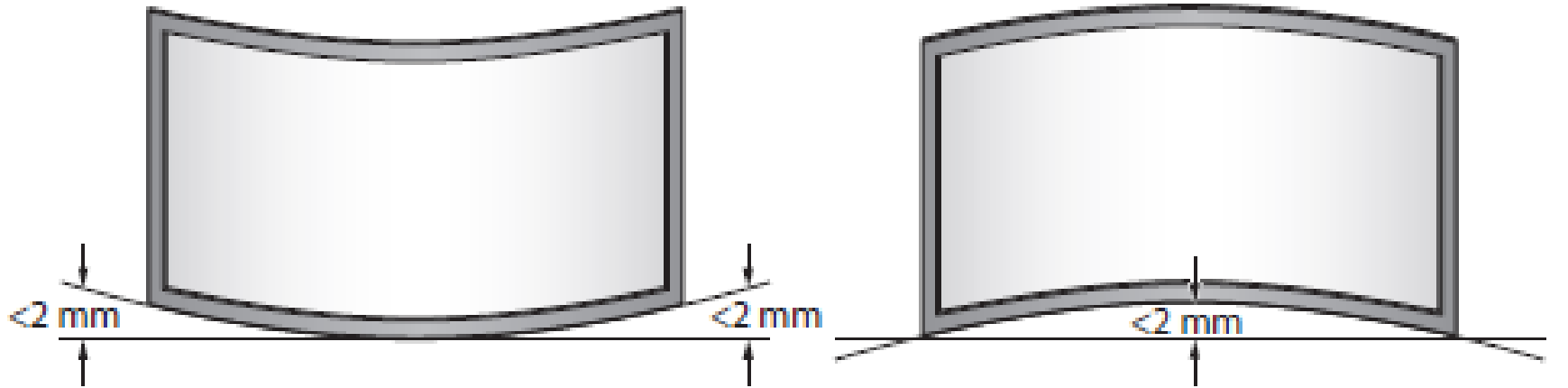



Projector Preparation

- Need 2 Projectors
- Install PointWrite Camera module on both projectors

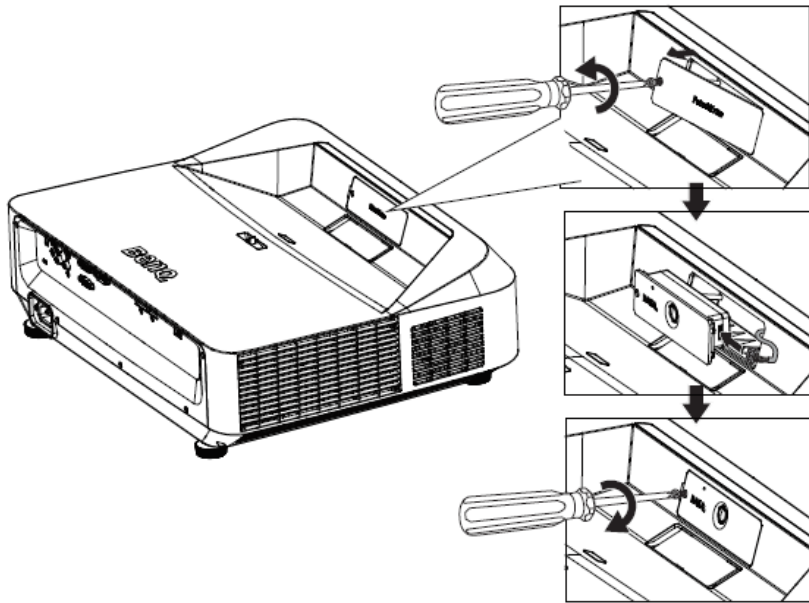

PW30U

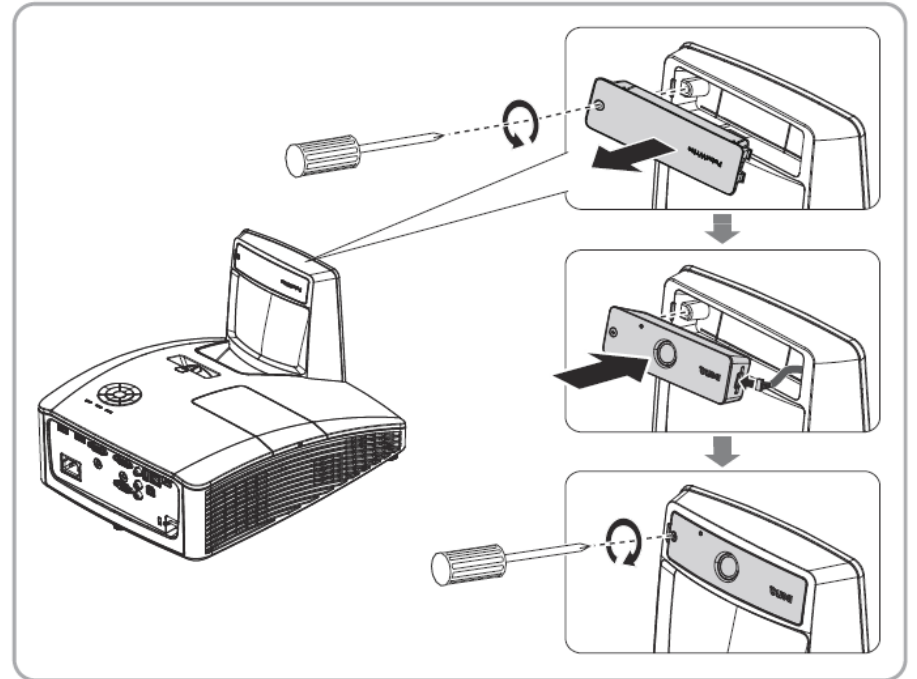

PW40U

Projection Alignment



- Using the test plan to check the dual screen condition.



Connection Setup



The left one

The right one

HDMI/VGA

HDMI/VGA

USB cable(PW40U)

USB cable(PW40U)

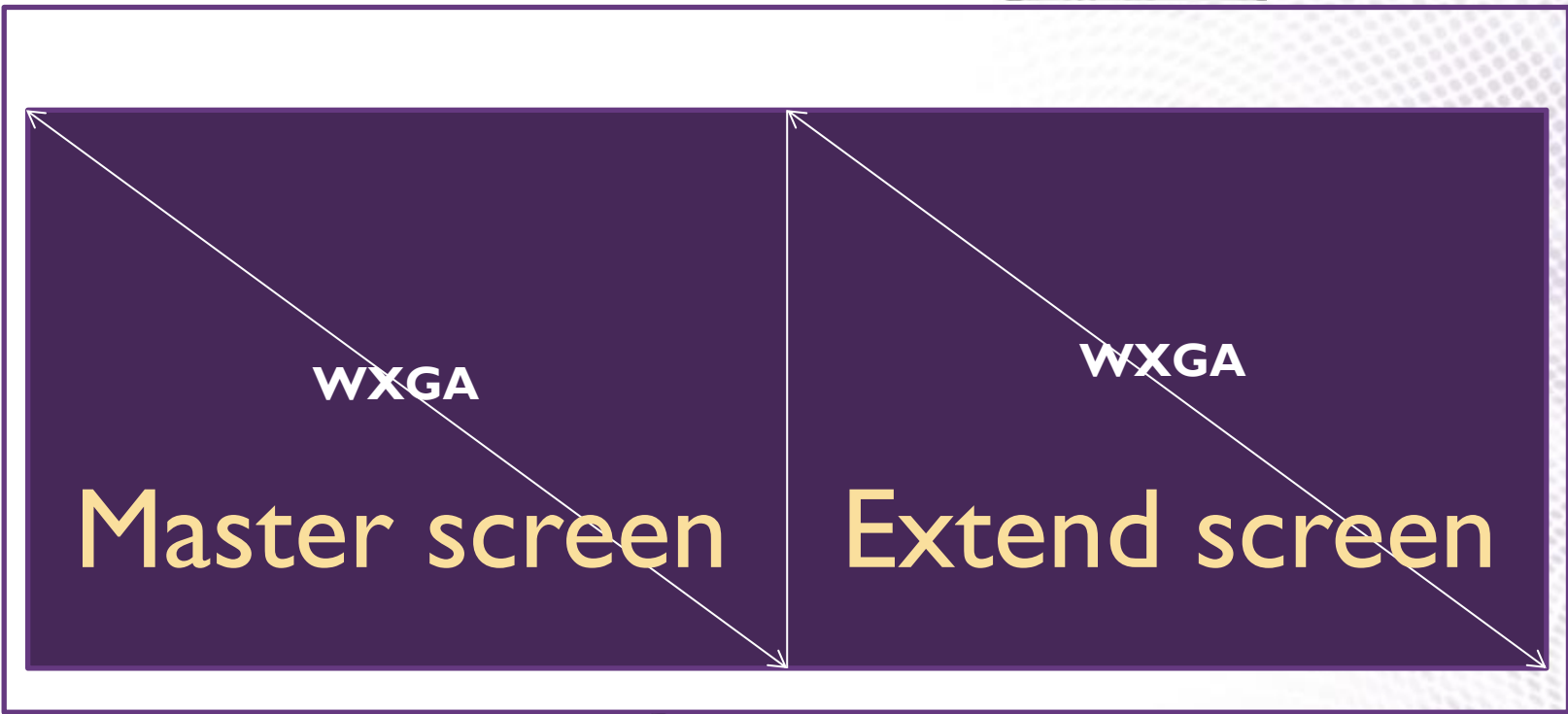

or



Check Connection Status



Check “Device Manager” from your computer to make sure that 2 PointWrite devices is recognized by your computer.

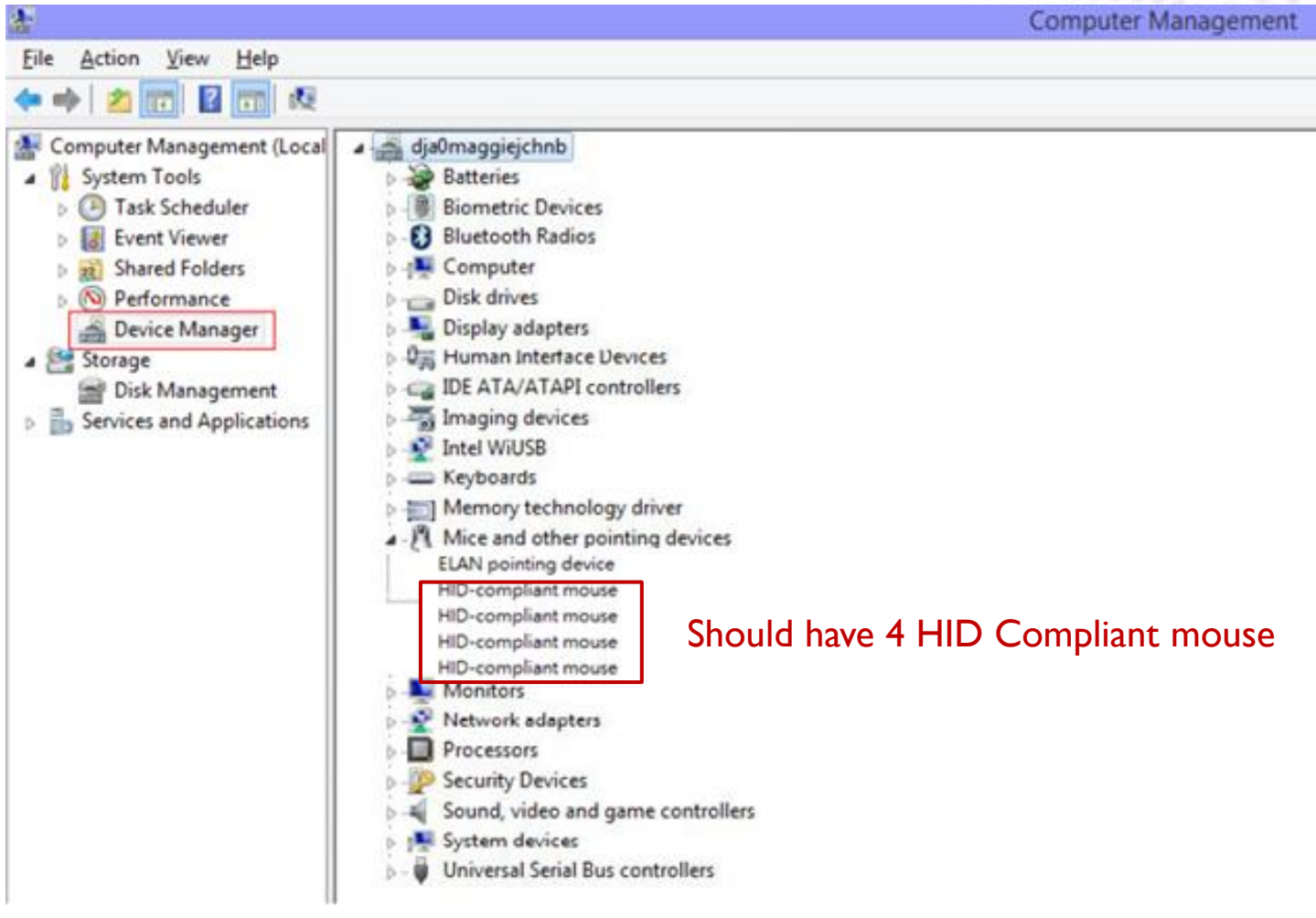

Display setting-PC



The left one



The right one

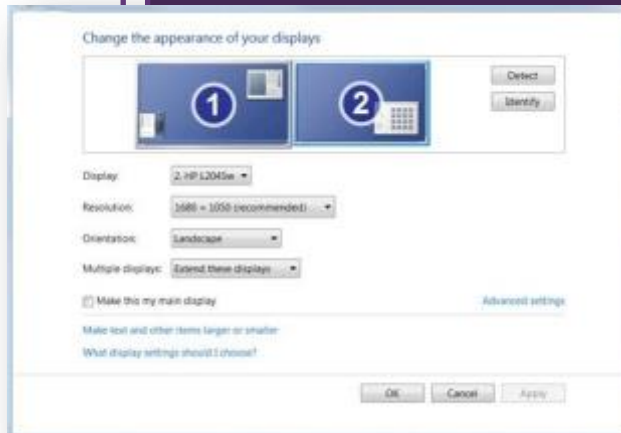
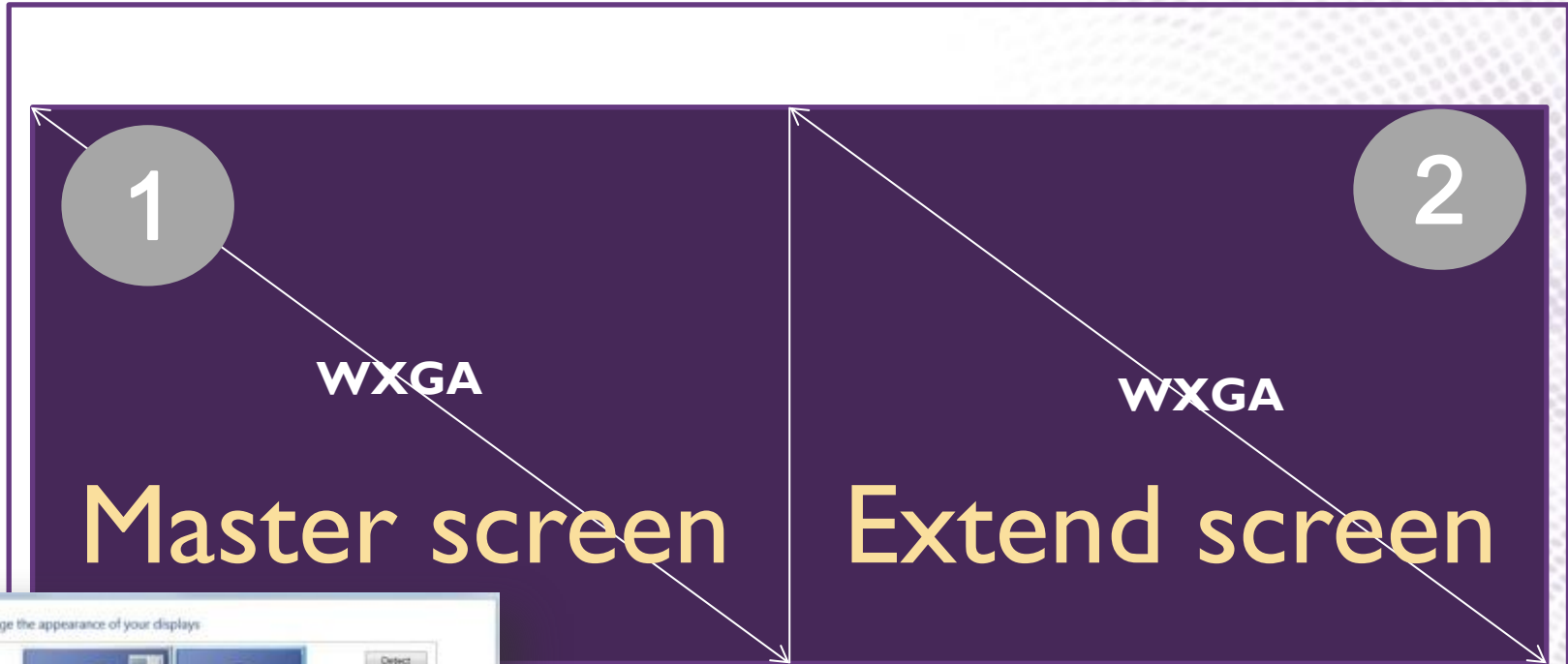

Control Panel > Appearance and Personalization > Display > Screen Resolution > Change the appearance of your display

- Set the left projector as the main display(Display 1).
- Set the right projector as extended screen(Display 2)
- Select “Extend these displays” for the multiple displays setting.

Display setting-Laptop(1)

① Launch Resolution control panel
(Right click on an empty area of the desktop)

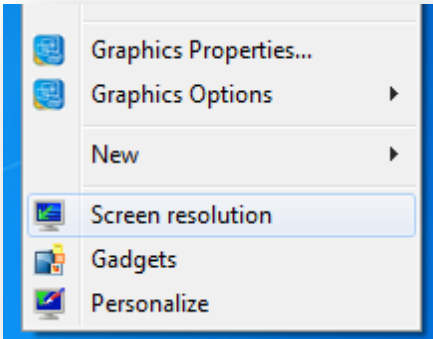

② Extend the display to the left projector

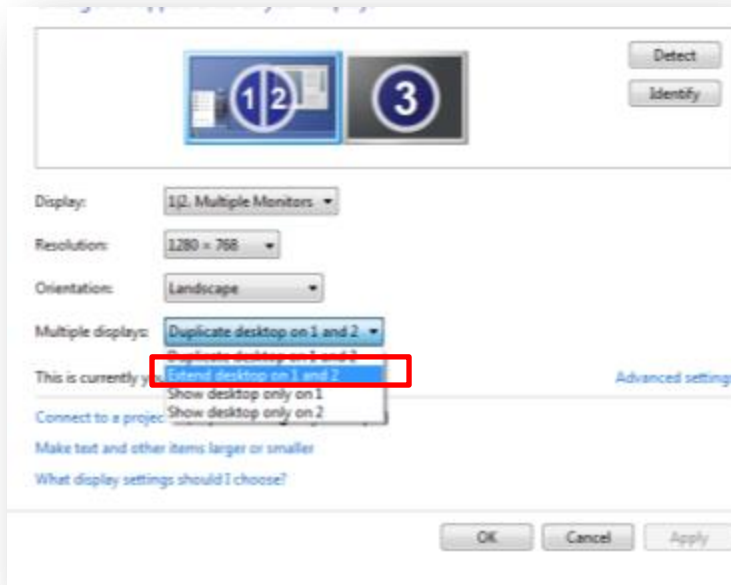

③ Set the left projector as the main display
(Click Screen 2 and check)

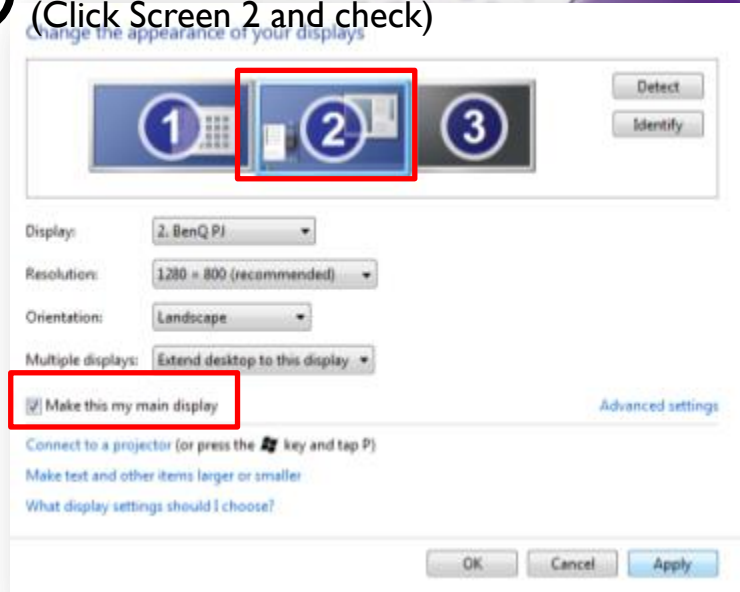

④ Disconnect the display of laptop
(Click Screen 1 for the options)

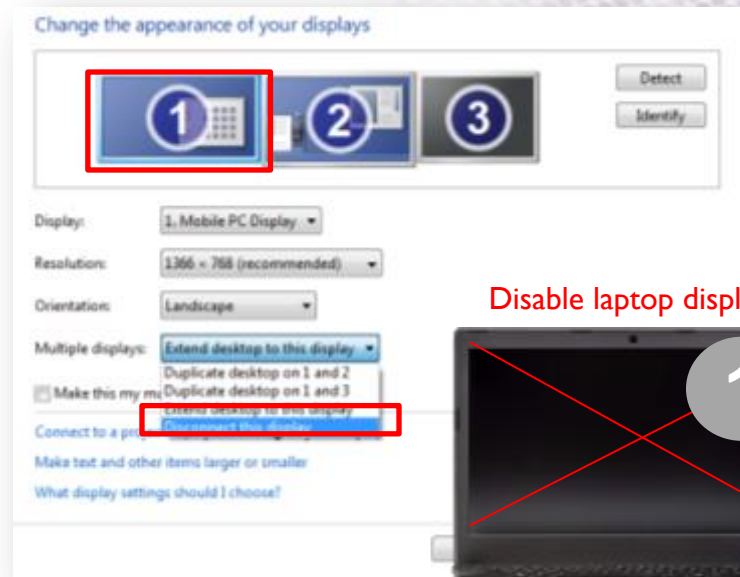



Display setting-Laptop(2)

- ⑤ Extend the display to the right projector
(Click Screen 3 for the options)

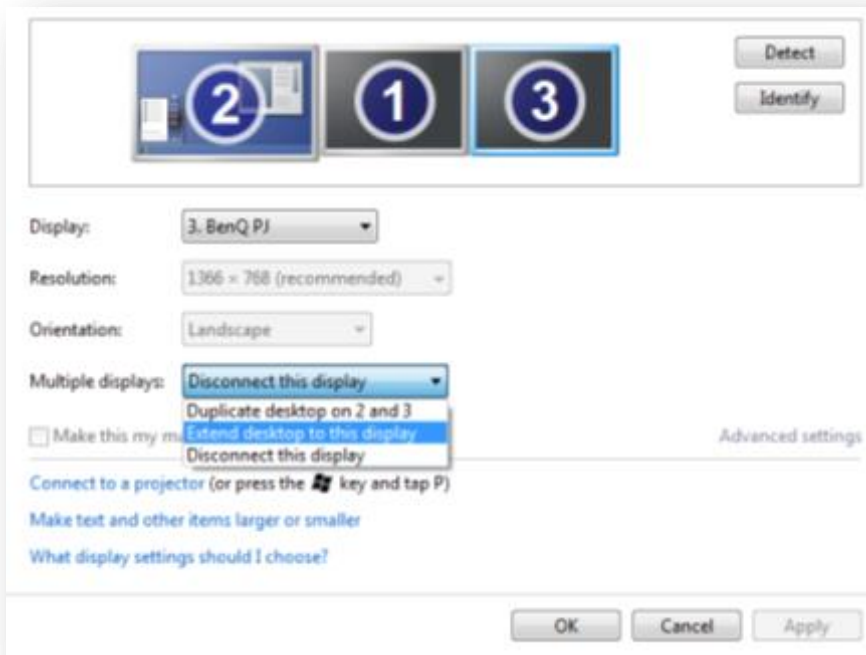

- ⑥ Apply the setting and keep changes

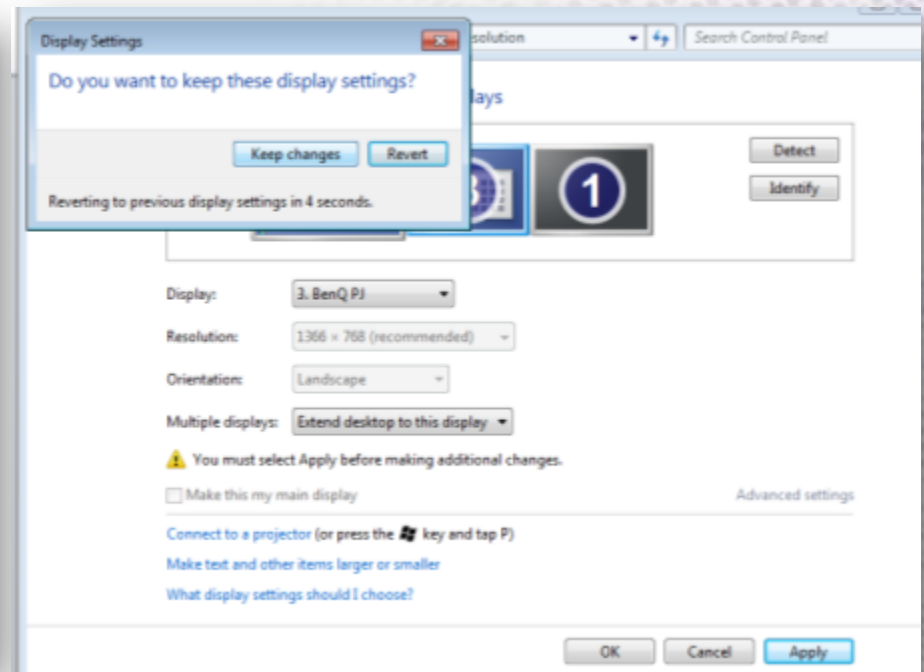

Check Display Setting



The left one



The right one

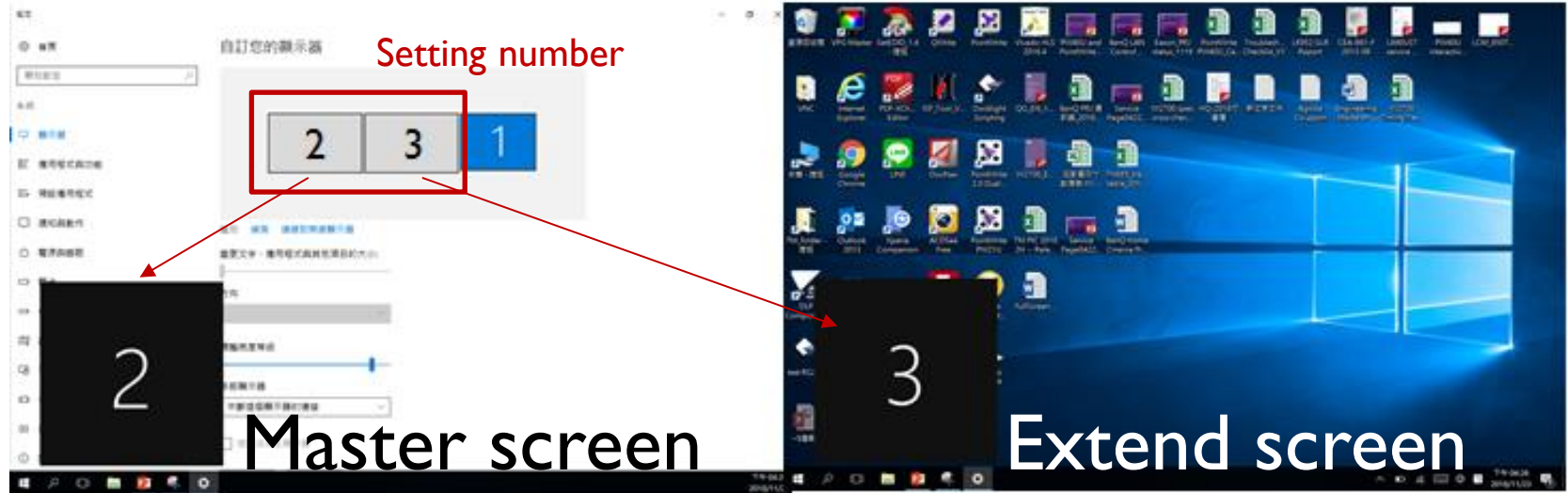

- 1. Press “Identify”, A number will show up on each screen, check if the sequence of showed number is corresponsive with the sequence of setting number**
The left Projector(Master screen): show “2” →The left side of the your setting number is “2”
The Right Projector(Extend screen): show “3”→The right side of the your setting number is “3”
- 2. The sequence of setting number is different from PCs**
- 3. To secure the quality of interactive function, the Resolution for each screen should be the same as Projector Native resolution.**
→When the resolution for both screen is different, it will show a reminding windows, check the **resolution setting**

Camera Configuration Setting



① Launch PointWrite 2.0 DualDriver on desktop

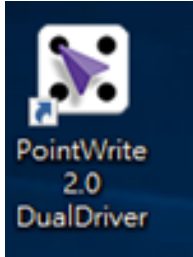

③ Configuration setting

3-1 Choose “Program Auto Run”

*Auto Run means the program will run automatically when turning on your PC

3-2 Choose installation mode

② Click Configuration to launch control panel

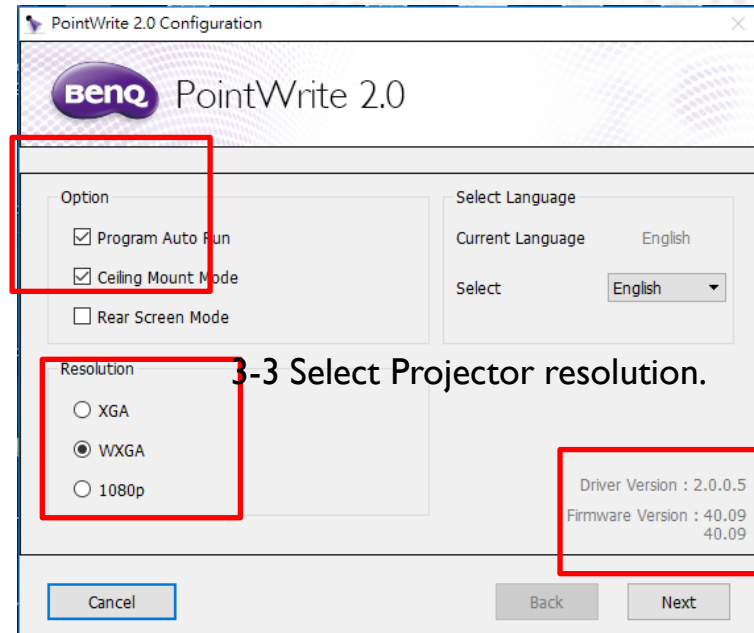
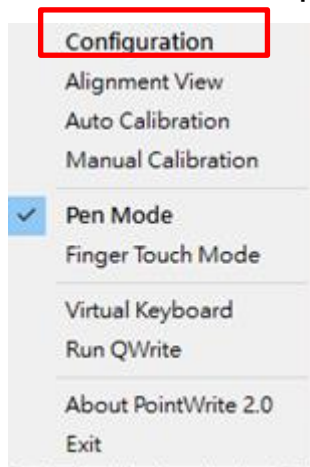

3-3 Select Projector resolution.

3-3 Check dual screen Driver/PointWrite Module FW version

- ✓ The 2 FW version showed indicates both PointWrite Module
→ This means both PointWrite Modules are detected.
- ✓ Check if Dual driver version is the latest.
- ✓ Check the connectivity/quality of USB cable when showing abnormal version number

After finishing above items, click “Next”

Camera Alignment Setting



- ④ Check Alignment View for both PointWrite Module

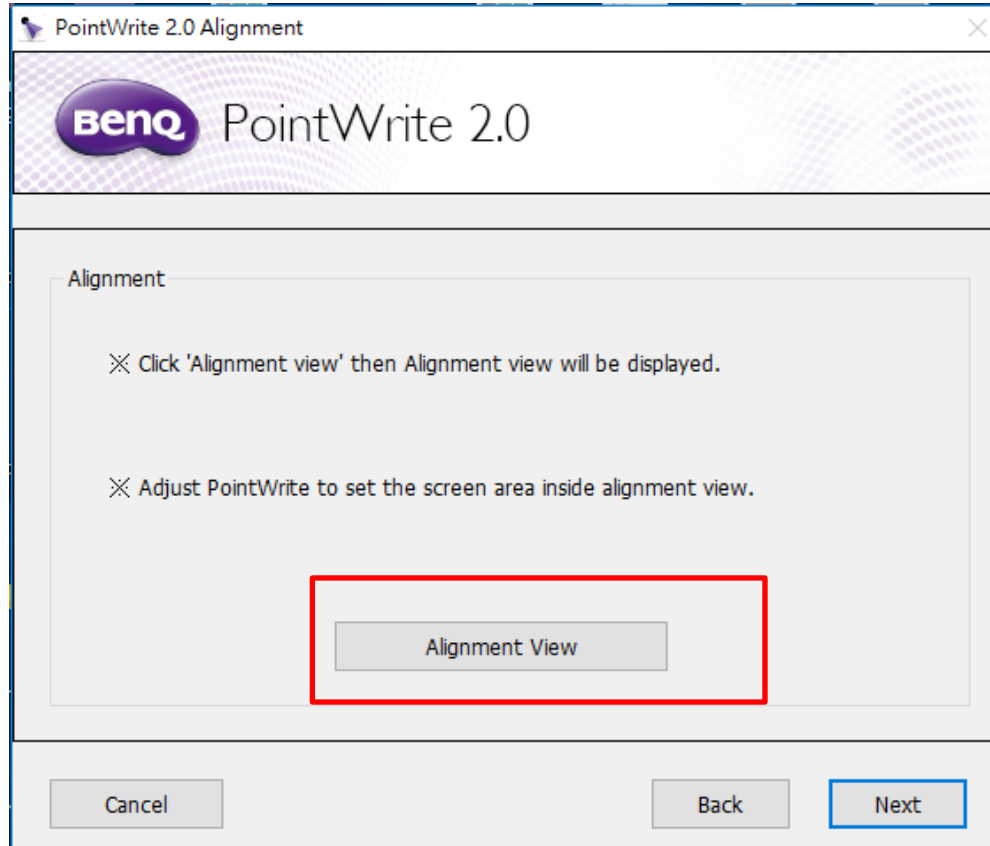



Check Alignment View-Method I

① The Alignment view will depend on the projector's installation position

When Projector is in **Ceiling mode**, the alignment view should be like below:



When Projector is in **Desktop mode**, the alignment view should be like below:

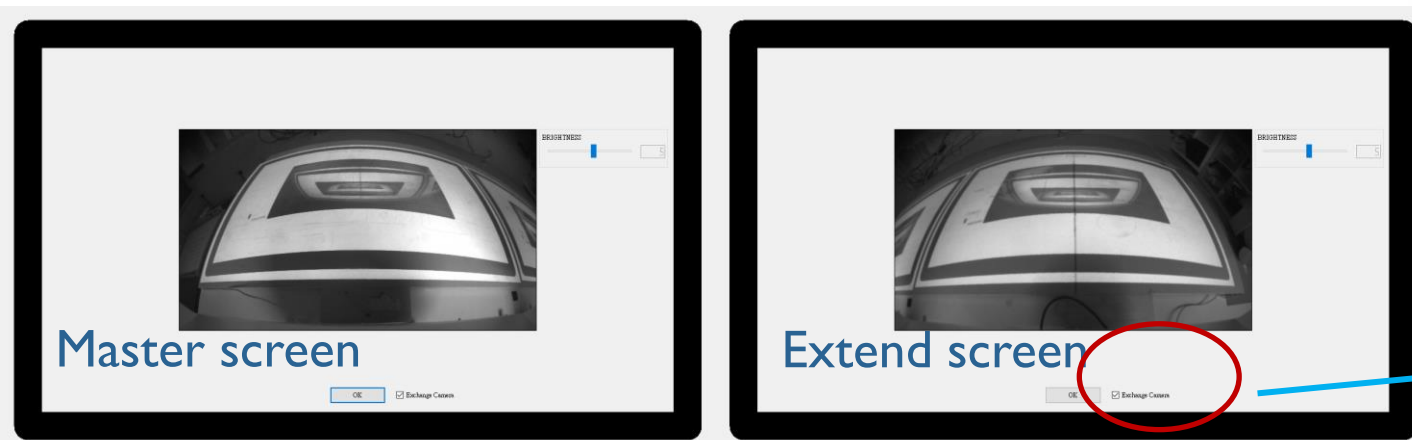

**If the actual alignment view does not match the above description, press "Exchange Camera"

Check Alignment View-Method 2

- ② You can also press the pen tip on both screen, if the screen shows a highlight, this means the camera capture the correct screen image

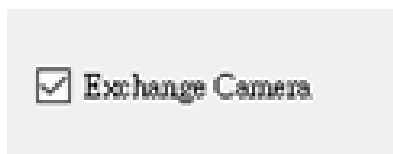
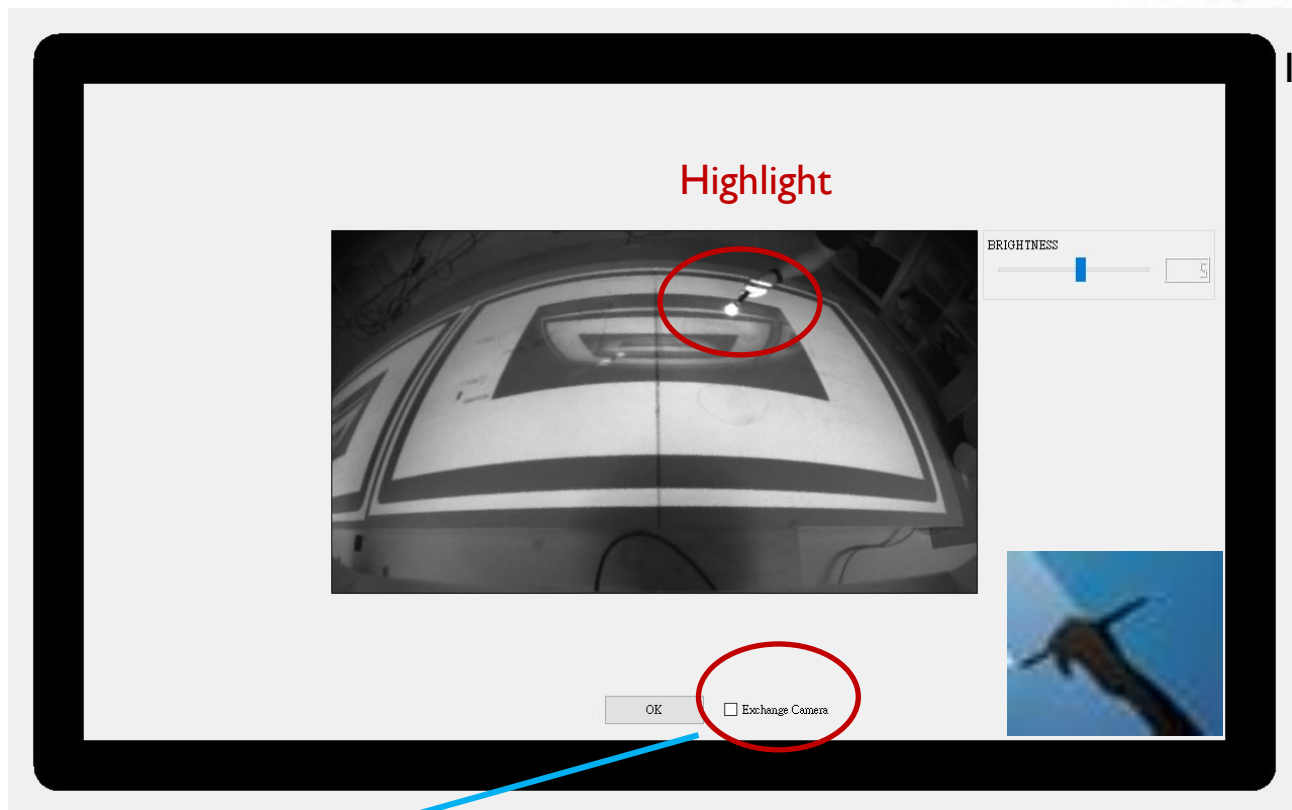

If camera capture the wrong screen image, press “Exchange Camera”

When finishing the alignment view checking, Press OK

Calibration



PointWrite 2.0 Calibration

BenQ PointWrite 2.0

Calibration

PointWrite provides two kinds of calibration methods.

- ✕ Auto Calibration [Calibration is proceeded automatically.]
- ✕ Manual Calibration [User clicks the points appearing on the screen directly.]

Auto Manual

Cancel Back Finish

Choose Auto or Manual calibration

Calibration-Manual

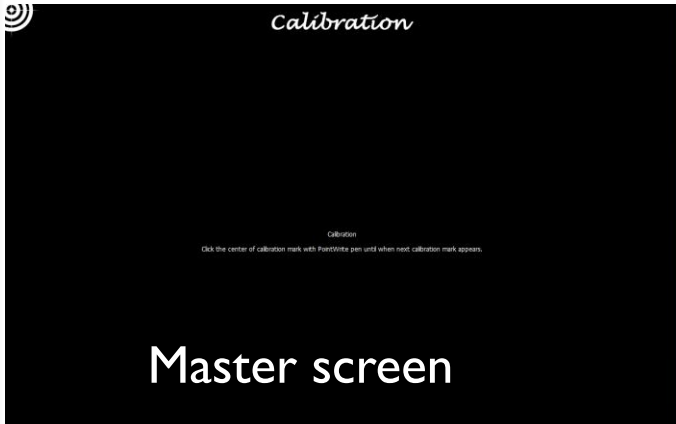

Master screen



Extend screen

① Calibration for Master screen

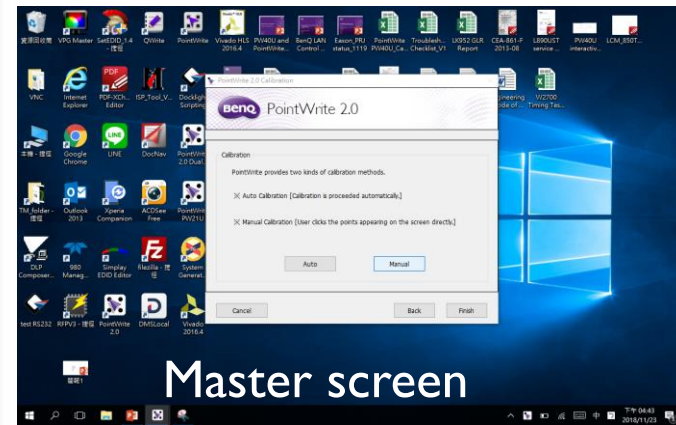

Master screen

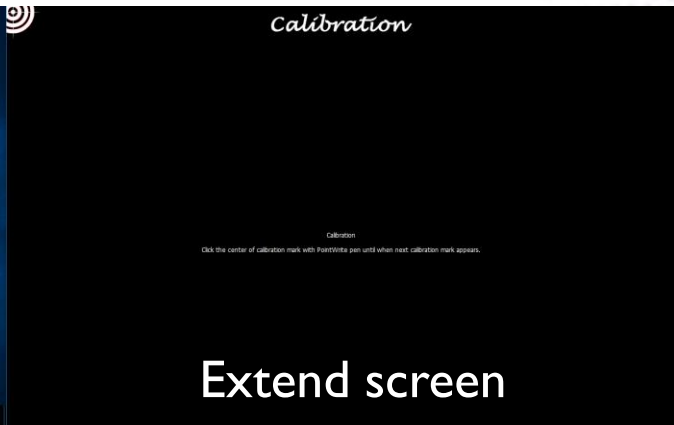

Extend screen

② Calibration for Extend screen

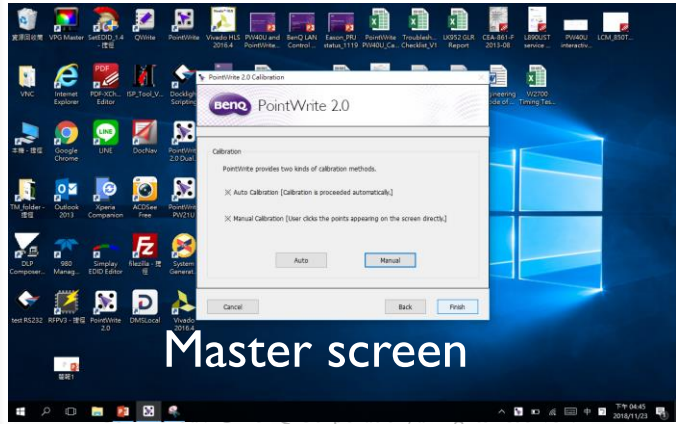

Master screen



Extend screen

③ Manual Calibration finished, press "Finish"

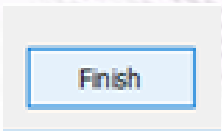

Calibration-Auto

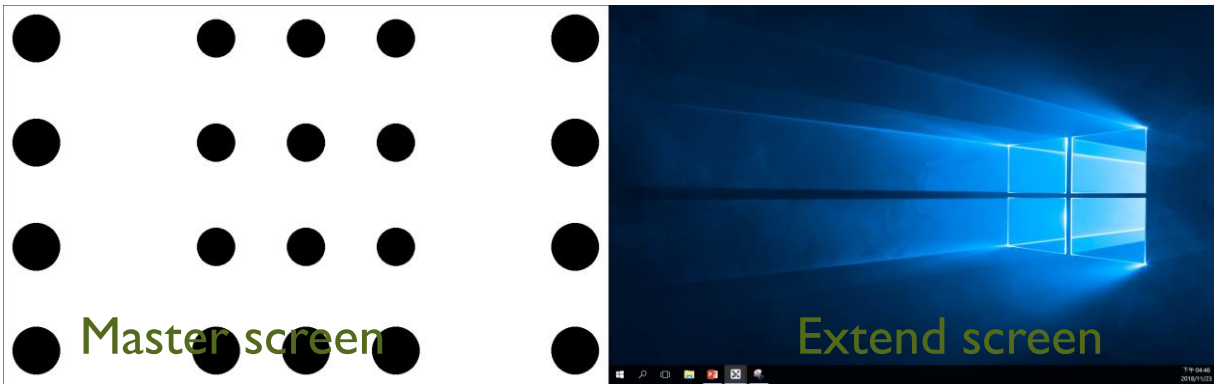

① Calibration for Master screen

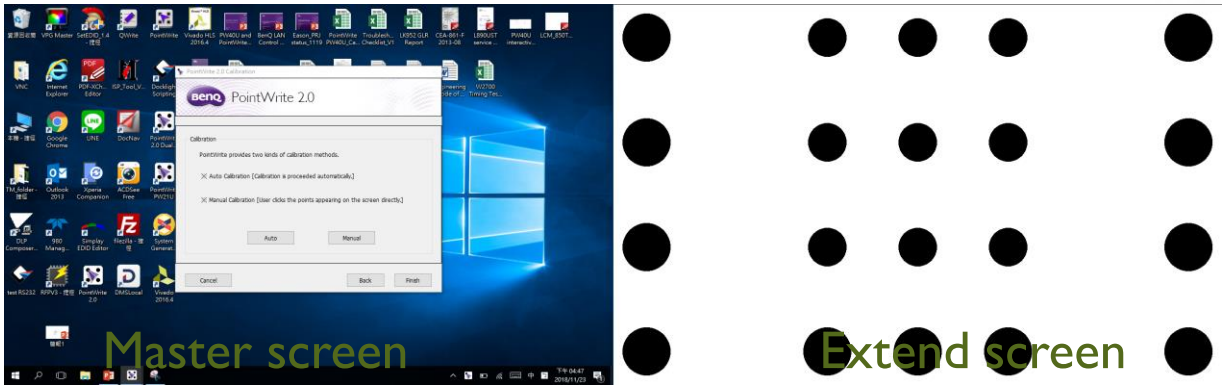

② Calibration for Extend screen



③ Auto Calibration finished, press "Finish"

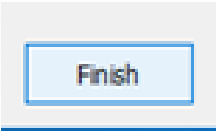

QWrite Dual Screen Mode Setting



① Launch QWrite

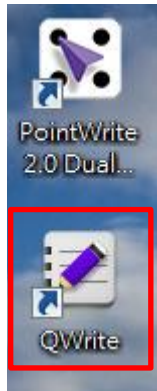

From desktop

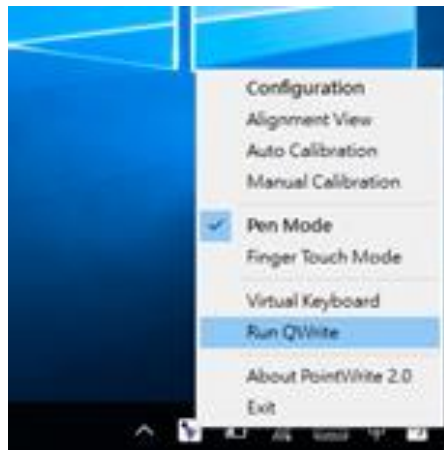

From Toolbar

② Select Configuration to launch control panel

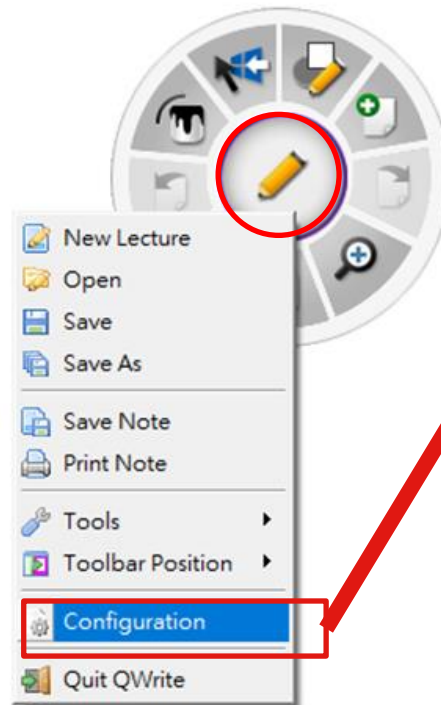

③ Select dual display mode in Dual Display setting

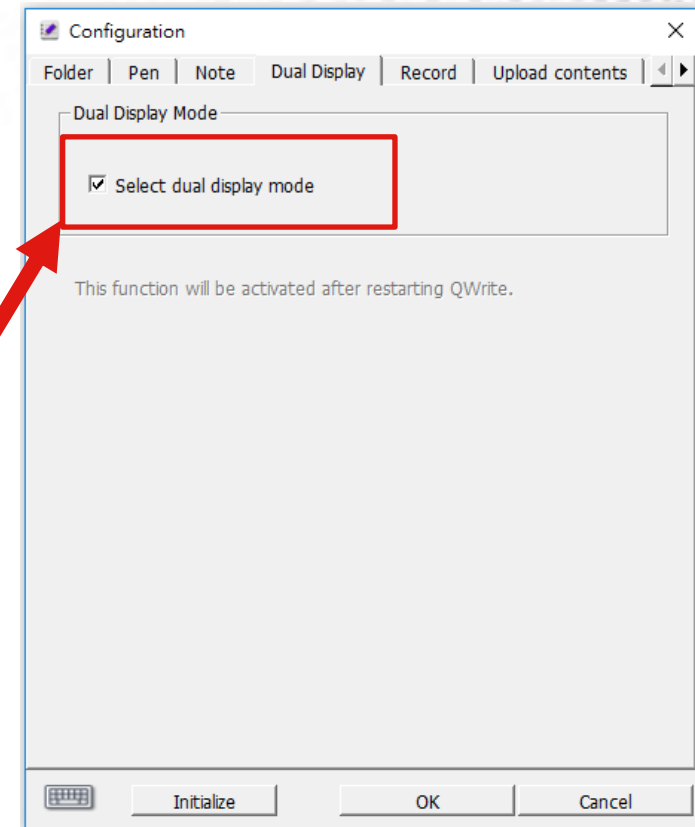

④ Quit QWrite and re-launch QWrite to active the dual display setting

Start for dual screen projection



The left one



The right one



1/1





Because it matters