



LCD Monitor

# User Manual

Programming Monitor | RD Series

## Copyright

Copyright © 2024 by BenQ Corporation. All rights reserved. No part of this publication may be reproduced, transmitted, transcribed, stored in a retrieval system or translated into any language or computer language, in any form or by any means, electronic, mechanical, magnetic, optical, chemical, manual or otherwise, without the prior written permission of BenQ Corporation.

## Disclaimer

BenQ Corporation makes no representations or warranties, either expressed or implied, with respect to the contents hereof and specifically disclaims any warranties, merchantability or fitness for any particular purpose. Further, BenQ Corporation reserves the right to revise this publication and to make changes from time to time in the contents hereof without obligation of BenQ Corporation to notify any person of such revision or changes.

BenQ flicker-free technology maintains a stable backlight with a DC dimmer that eliminates the primary cause of monitor flicker, making it easier on the eyes. The performance of flicker-free may be affected by external factors such as poor cable quality, unstable power supply, signal interference, or poor grounding, and not limited to the above mentioned external factors. (Applicable for flicker-free models only.)

## BenQ ecoFACTS

BenQ has been dedicated to the design and development of greener product as part of its aspiration to realize the ideal of the "Bringing Enjoyment 'N Quality to Life" corporate vision with the ultimate goal to achieve a low-carbon society. Besides meeting international regulatory requirement and standards pertaining to environmental management, BenQ has spared no efforts in pushing our initiatives further to incorporate life cycle design in the aspects of material selection, manufacturing, packaging, transportation, using and disposal of the products. BenQ ecoFACTS label lists key eco-friendly design highlights of each product, hoping to ensure that consumers make informed green choices at purchase. Check out BenQ's CSR Website at <http://csr.BenQ.com/> for more details on BenQ's environmental commitments and achievements.

## Product carbon footprint (PCF)

The carbon footprint of a product is the estimated carbon emission throughout its entire life cycle. The information may be available on the package or [online](#).

The carbon footprint stated for this product is the current estimate and the actual result may be subject to change due to unforeseen conditions. This means the actual product carbon footprint may be different from the declared statement.

You may not find your product's carbon footprint as it was not available at the time the product was shipped. The information should be online once it's available.



# Product support

This document aims to provide the most updated and accurate information to customers, and thus all contents may be modified from time to time without prior notice. Please visit the website for the latest version of this document and other product information. Available files vary by model.

1. Make sure your computer is connected to the Internet.
2. Visit the local website from [Support.BenQ.com](https://Support.BenQ.com). The website layout and content may vary by region/country.
  - User manual and related document
  - Drivers and applications
  - (EU only) Dismantled information: Available on the user manual download page. This document is provided based on Regulation (EU) 2019/2021 to repair or recycle your product. Always contact the local customer service for servicing within the warranty period. If you wish to repair an out-of-warranty product, you are recommended to go to a qualified service personnel and obtain repair parts from BenQ to ensure compatibility. Do not disassemble the product unless you are aware of the consequences. If you cannot find the dismantled information on your product, contact the local customer service for assistance.

## Firmware upgrade

You are recommended to upgrade the product to the latest firmware version (if available) and refer to the most up-to-date user manual to make best use of the product.

To upgrade your monitor, download and install the **Display QuickKit** software from the BenQ website.

- [Support.BenQ.com](https://Support.BenQ.com) > model name > **Software & Driver** > **Display QuickKit** (available only when your monitor is compatible)
- [Support.BenQ.com](https://Support.BenQ.com) > **Display QuickKit** (availability may vary by region)

The software utility checks the compatibility of your monitor automatically once launched. Refer to the user manual of the software utility for instructions.

If your monitor is not compatible with **Display QuickKit**, and you wonder if there is an updated firmware version available, please contact BenQ customer service.

## Advanced software

Apart from the built-in technologies and features available on this product, you are provided with more software applications to enhance and extend the product functionality. Download the software and its user guide as instructed from the BenQ website.

### • Display Pilot 2

**Display Pilot 2** is a software utility that allows for quick accurate tuning of the display with the ability to easily save and use monitor configurations that are best suited for you. All adjustments are controlled via software to eliminate the need to use the monitor on-screen displays (OSD).

EPREL Registration Number:  
RD240Q: 1808422  
RD280U: 1867959  
RD280UA: 1867961

RD320U: 2034604  
RD320UA: 2034605



# Q&A index

Start with the topics that you are interested in.

## Setup

### How to set up the monitor and turn it on?

Safety precautions	7
How to assemble your monitor hardware (for models with stand)	25
How to assemble your monitor hardware (for models with ergo arm stand)	31
Adjusting the monitor angle	40

### How to adjust the monitor viewing angle?

Viewing angle adjustment	41
--------------------------	----

### How to wall mount the monitor?

Using the monitor wall mounting kit (purchased separately)	42
--	----

## Useful tools to enhance efficiency

### How can I efficiently manage the display settings?

Display Pilot 2	4
-----------------	---

### How to boost coding productivity using Coding HotKey and Function Key?

Customizing the Function Key	45
Working with Quick Menu	46

### How to experience focus any time with MoonHalo?

Working with Quick Menu for MoonHalo (selected models only)	47
Working with MoonHalo (selected models only)	47

### Can I save power and protect screen privacy when I leave my seat?

Protecting your screen privacy (EcoPrivacy)	48
---	----

### How to connect two or more monitors to have more screen space?

Connecting multiple monitors via MST (Multi-Stream Transport)	52
---	----

### Can I control two computers with one set of keyboard and mouse?

Sharing a set of keyboard, mouse, and other USB peripherals with KVM (selected models only)	54
---	----

### How to split my screen to show two sources at the same time?

Displaying two sources at the same time (PBP/PIP) (selected models only)	55
--	----

### How to apply two color modes while in dual views?

Displaying two color settings at the same time (DualView Plus)(selected models only)	55
--	----

## Functions to reduce eye strain

<b>How to minimize my screen brightness under extremely dark environment?</b>	
Working with Night Hours Protection	48
<b>How to set the appropriate screen brightness?</b>	
Adjusting screen brightness automatically (Brightness Intelligence Gen2)	49
<b>How to reduce the blue light emitted from the display?</b>	
Working with Low Blue Light Plus	48
<b>Can the monitor reminds me to take a break automatically after a set period of time?</b>	
Resting your eyes with the help of Eye Reminder	49

## Menus and accessories

<b>Can I set hot keys to fequently used functions or menus?</b>	
Customizing the Function Key	45
Working with Quick Menu	46
<b>How to use the OSD menu?</b>	
5-way controller and basic menu operations	44
Navigating the main menu	57

## Maintenance and product support

<b>How to clean the monitor?</b>	
Care and cleaning	9
Cleaning the LCD screen	12
<b>How to keep the monitor not in use for a long time?</b>	
How to detach the stand (for models with stand)	30
How to detach the stand (for models with ergo arm stand)	39
Care and cleaning	9
<b>I need more support.</b>	
Product support	4
Servicing	10

# Safety precautions

## Power safety



Please follow these safety instructions for best performance, and long life for your monitor.



- The AC plug isolates this equipment from the AC supply.
- The power supply cord serves as a power disconnect device for pluggable equipment. The socket outlet should be installed near the equipment and be easily accessible.
- This product should be operated from the type of power indicated on the marked label. If you are not sure of the type of power available, consult your dealer or local power company.
- The Class I pluggable equipment Type A must be connected to protective earth.
- An approved power cord greater or equal to H03VV-F or H05VV-F, 2G or 3G, 0.75mm<sup>2</sup> must be used.
- Use only the power cord provided by BenQ. Never use a power cord that appears to be damaged or frayed.
- To avoid possible damage to the monitor, do not use it in a region where power supply is unstable.
- Ensure that the power cord is connected to a grounded power outlet before turning on the monitor.
- To avoid possible danger, observe the total electric load when using the monitor with a (multi-outlet) extension cord.
- Always turn off the monitor before unplugging the power cord.

For Germany only:

- (If the weight of the product is less than or equal to 3 kg) An approved power cord greater or equal to H03VV-F, 3G, 0.75mm<sup>2</sup> must be used.
- (If the weight of the product is more than 3 kg) An approved power cord greater or equal to H05VV-F or H05RR-F, 3G, 0.75mm<sup>2</sup> must be used.
- (If a remote control is provided) RISK OF EXPLOSION IF BATTERY IS REPLACED BY AN INCORRECT TYPE. DISPOSE OF USED BATTERIES ACCORDING TO THE INSTRUCTIONS.

For models with adapter:

- Use only the power adapter supplied with your LCD Monitor. Use of another type of power adapter will result in malfunction and/or danger.
- Allow adequate ventilation around the adapter when using it to operate the device or charge the battery. Do not cover the power adapter with paper or other objects that will reduce cooling. Do not use the power adapter while it is inside a carrying case.
- Connect the power adapter to a proper power source.
- Do not attempt to service the power adapter. There are no service parts inside. Replace the unit if it is damaged or exposed to excess moisture.

## Installation

- Do not use your monitor under any of the following environmental conditions:
  - Extremely high or low temperature, or in direct sunlight
  - Dusty places
  - Highly humid, exposed to rain, or close to water
  - Exposed to vibrations or impacts in places such as cars, buses, trains, and other rail vehicles
  - Near heating appliances such as radiators, heaters, fuel stoves, and other heat-generating items (including audio amplifiers)
  - An enclosed place (such as a closet or bookcase) without appropriate ventilation
  - An uneven or sloping surface
  - Exposed to chemical substances or smoke
- Carry the monitor carefully.
- Do not place heavy loads on the monitor to avoid possible personal injury or damage to the monitor.
- Ensure that children do not hang or climb onto the monitor.
- Keep all packing bags out of reach of children.

## Operation

- To protect your eyesight, please refer to the user manual to set the optimal screen resolution and the viewing distance.
- To reduce eye fatigue, take a break on a regular basis while using the monitor.
- Avoid taking either one of the following actions for a long time. Otherwise, burn marks may occur.
  - Play images that cannot occupy the screen entirely.
  - Place a still image on the screen.
- To avoid possible damage to the monitor, do not touch the monitor panel by finger tip, pen, or any other sharp objects.
- Excessively frequent plug and unplug of video connectors may cause damage to the monitor.
- This monitor is designed mainly for personal use. If you want to use the monitor in a public place or a harsh environment, contact your nearest BenQ service center for assistance.
- To avoid possible electric shock, do not disassemble or repair the monitor.
- If a bad smell or an abnormal sound appears to come from the monitor, contact your nearest BenQ service center for assistance immediately.

## Caution

- The distance between you and the monitor should be 2.5 to 3 times the diagonal width of the screen.
- Looking at the screen for an extended period of time causes eye fatigue and may deteriorate your eyesight. Rest your eyes for 5 ~ 10 minutes for every 1 hour of product use.
- Reduce your eye strain by focusing on objects far away.
- Frequent blinking and eye exercise help keep your eyes from drying out.

## Safety notice for remote control (applicable if a remote control is provided)

- Do not put the remote control in the direct heat, humidity, and avoid fire.
- Do not drop the remote control.
- Do not expose the remote control to water or moisture. Failure to do so could result in malfunction.
- Confirm there is no object between the remote control and the remote sensor of the product.
- When the remote control will not be used for an extended period, remove the batteries.

## Battery safety notice (applicable if a remote control is provided)

The use of the wrong type of batteries may cause chemical leaks or explosion. Please note the following:

- Always ensure that the batteries are inserted with the positive and negative terminals in the correct direction as shown in the battery compartment.
- Different types of batteries have different characteristics. Do not mix different types.
- Do not mix old and new batteries. Mixing old and new batteries will shorten battery life or cause chemical leaks from the old batteries.
- When batteries fail to function, replace them immediately.
- Chemicals which leak from batteries may cause skin irritation. If any chemical matter seeps out of the batteries, wipe it up immediately using a dry cloth, and replace the batteries as soon as possible.
- Due to varying storage conditions, the battery life for the batteries included with your product may be shortened. Replace them within 3 months or as soon as you can after initial use.
- There may be local restrictions on the disposal or recycling of batteries. Consult your local regulations or waste disposal provider.

If the supplied remote control contains a coin / button cell battery, pay attention to the following notice as well.

- Do not ingest battery. Chemical Burn Hazard.
- The remote control supplied with this product contains a coin / button cell battery. If the coin / button cell battery is swallowed, it can cause severe internal burns in just 2 hours and can lead to death.
- Keep new and used batteries away from children. If the battery compartment does not close securely, stop using the product and keep it away from children.
- If you think batteries might have been swallowed or placed inside any part of the body, seek immediate medical attention.

## Care and cleaning

- Do not place the monitor face down on the floor or a desk surface directly. Otherwise, scratches on the panel surface may occur.
- The equipment is to be secured to the building structure before operation.
- (For models that support wall or ceiling mounting)
  - Install your monitor and monitor mounting kit on a wall with flat surface.

- Ensure that the wall material and the standard wall mount bracket (purchased separately) are stable enough to support the weight of the monitor.
- Turn off the monitor and the power before disconnecting the cables from the LCD monitor.
- Always unplug the product from the power outlet before cleaning. To clean the monitor, see [Cleaning the LCD screen on page 12](#) for more information.
- Slots and openings on the back or top of the cabinet are for ventilation. They must not be blocked or covered. Your monitor should never be placed near or over a radiator or heat sources, or in a built-in installation unless proper ventilation is provided.
- Do not place heavy loads on the monitor to avoid possible personal injury or damage to the monitor.
- Consider keeping the box and packaging in storage for use in the future when you may need to transport the monitor.
- Refer to the product label for information on model name, power rating, manufacturing date, barcode, serial number, and identification markings. The locations of labels vary by model. See the illustration below for where the labels can be.

Possible label location:

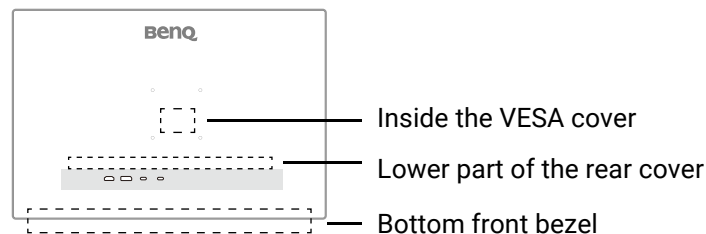

## Servicing

- Do not attempt to service this product yourself, as opening or removing covers may expose you to dangerous voltages or other risks. If any of the above mentioned misuse or other accident such as dropping or mishandling occurs, contact qualified service personnel for servicing.
- For replacement of power cord, connection cables, remote control or power adapter, please contact BenQ customer service.
- Contact your place of purchase or visit the local website from [Support.BenQ.com](http://Support.BenQ.com) for more support.



Support.BenQ.com



## General warranty information

Note that the monitor warranty may be void if any of the following conditions occurs:

- Documents required for warranty services have been altered by unauthorized use or is illegible.
- The model number or production number on the product has been altered, deleted, removed or made illegible.
- Repairs, modifications, or alterations have been made by unauthorized service organizations or persons.
- Damage caused by improper storage of the monitor (including but not limited to force majeure, direct exposure to sunlight, water, or fire).

- Reception problems occurred due to external signals (such as antenna, Cable TV) outside the monitor.
- Defects caused by abuse or misuse of the monitor.
- Before using the monitor, it is the sole responsibility of the user to check whether the monitor is compatible with local technical standards if the user brings the monitor out of its intended sales area. Failure to do so may cause product breakdown and the user will have to pay the repairing costs.
- It is the sole responsibility of the user if problems (such as data loss and system failure) occurred due to non-factory provided software, parts, and/or non-original accessories.
- Please use the original accessories (e.g. power cable) only with the device to avoid possible dangers such as electric shock and fire.

## Typography

Icon / Symbol	Item	Meaning
	Warning	Information mainly to prevent the damage to components, data, or personal injury caused by misuse and improper operation or behavior.
	Tip	Useful information for completing a task.
	Note	Supplementary information.

In this document, the steps needed to reach a menu may be shown in condensed form, for example: **Menu > System > Information.**

# Cleaning the LCD screen



Please follow these safety instructions for best performance, and long life for your monitor.

As your monitor panel comes with a special anti-glare coating, use and clean the monitor carefully.

- Stains on the monitor screen could be obvious. Be cautious when you use or clean the monitor and avoid getting oil or dust on the screen.
- Fingerprints and dust under normal use could be wiped away by a microfiber cleaning cloth.
- Clean the screen surface gently and carefully. Hard scrubbing could damage the screen coating.

Be sure to follow the instructions to clean the screen surface appropriately.

## Using a microfiber cleaning cloth (recommended)

You are recommended to use a microfiber cleaning cloth to clean your monitor screen. It is an eco-friendly design as it is reusable, washable, and liquid-free.

1. Unplug the monitor from the power outlet before cleaning.
2. Make sure there is no sharp debris on the cleaning cloth to avoid scratching the screen.
3. Hold the edge of the monitor and avoid excessive force on the screen.
4. Make sure the cleaning cloth is clean and dry. Start with a small, clean part of the cloth and wipe the stained area of the screen gently in circles. If it is still not clean, continue with another clean part of the cloth to avoid spreading the grease around. If both sides of the cloth are used and get dirty, wash and dry the cloth properly.

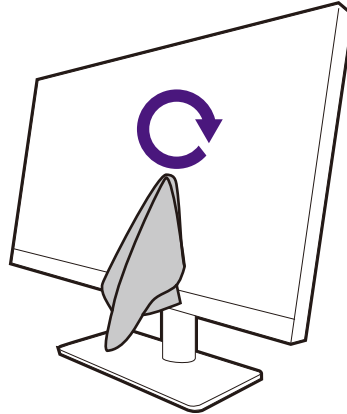

To prevent the seams around the cleaning cloth from marring the screen surface, avoid wiping the screen with the edge of the cleaning cloth.

5. If necessary, apply a small drop of alcohol-free screen cleaner on a small, clean part of the cleaning cloth, and wipe the stained area gently in circles. See [Using a screen cleaner on page 13](#) for more information.



6. Use a clean part of the cloth to wipe dry the screen completely. If it is still not clean, continue with another clean part of the cloth to avoid spreading the grease around. Repeat this step until the screen is clean.

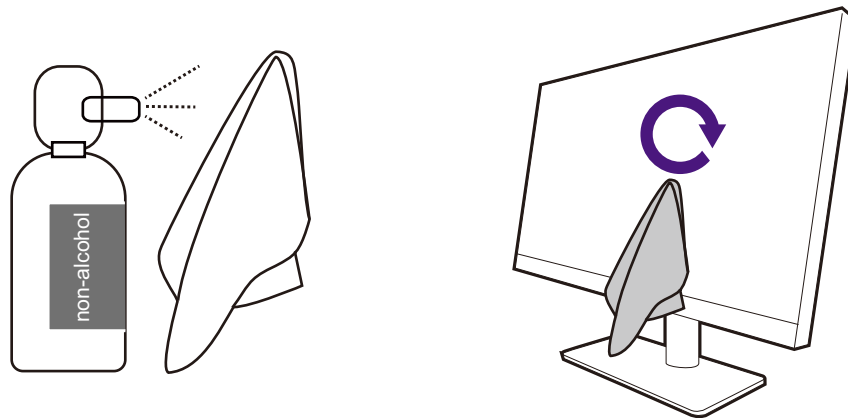

7. The cleaning cloth may get dirty after using several times and may not be able to clean the screen properly. Wash it with detergent and remove debris from it by hand if necessary. Keep it in a cool place until it is dry. Make sure it is completely dry before next cleaning.

## Using a screen cleaner

- Use screen cleaning wipes which are pre-moistened and alcohol-free. You can wipe away oil and fingerprints easily.
- Use an alcohol-free screen cleaner kit. Spray on the microfiber cloth that came with the screen cleaner kit, and wipe stains off the screen. Never spray anything directly onto the screen.
- Make sure no liquid goes into the gap between the screen and the bezel. Liquids inside the monitor could cause short circuits.

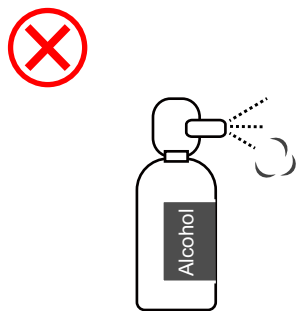



# Table of Contents



Copyright .....	2
BenQ ecoFACTS .....	3
Product support .....	4
Firmware upgrade .....	4
Advanced software .....	4
Q&A index .....	5
Safety precautions .....	7
Power safety .....	7
Installation .....	8
Operation .....	8
Safety notice for remote control (applicable if a remote control is provided) .....	9
Battery safety notice (applicable if a remote control is provided) .....	9
Care and cleaning .....	9
Servicing .....	10
General warranty information .....	10
Cleaning the LCD screen .....	12
Using a microfiber cleaning cloth (recommended) .....	12
Using a screen cleaner .....	13
Getting started .....	16
Getting to know your monitor .....	18
Front view .....	18
Back view .....	19
Connections .....	21
Power delivery of USB-C™ port on your monitor .....	24
How to assemble your monitor hardware (for models with stand) .....	25
How to detach the stand (for models with stand) .....	30
How to assemble your monitor hardware (for models with ergo arm stand) .....	31
Mounting options .....	31
Prior to assembling .....	31
Setup .....	34
How to detach the stand (for models with ergo arm stand) .....	39
Adjusting the monitor angle .....	40
Adjusting the monitor height .....	40
Rotating the monitor (selected models only) .....	40
Viewing angle adjustment .....	41
Using the monitor wall mounting kit (purchased separately) .....	42
How to adjust your monitor .....	43

The function bar .....	43
5-way controller and basic menu operations .....	44
Customizing the Function Key.....	45
Working with <b>Quick Menu</b> .....	46
Working with <b>Quick Menu</b> for <b>MoonHalo</b> (selected models only) .....	47
Working with <b>MoonHalo</b> (selected models only) .....	47
Working with <b>Night Hours Protection</b> .....	48
Protecting your screen privacy ( <b>EcoPrivacy</b> ) .....	48
Working with <b>Low Blue Light Plus</b> .....	48
Adjusting screen brightness automatically ( <b>Brightness Intelligence Gen2</b> ) .....	49
Enabling color vision accessibility ( <b>Color Weakness</b> ) .....	49
Resting your eyes with the help of <b>Eye Reminder</b> .....	49
Adjusting display mode.....	49
Choosing an appropriate color mode .....	50
Available menu options to each <b>Color Mode</b> .....	50
Connecting multiple monitors via MST (Multi-Stream Transport) .....	52
Sharing a set of keyboard, mouse, and other USB peripherals with KVM (selected models only) .....	54
Displaying two sources at the same time (PBP/PIP) (selected models only) .....	55
Displaying two color settings at the same time ( <b>DualView Plus</b> )(selected models only)... ..	55
Charging the connected device via USB-C™ port .....	56
<b>Navigating the main menu</b> .....	57
<b>Input</b> menu (selected models only) .....	58
<b>Display</b> menu (selected models only) .....	59
<b>Coding Booster</b> menu .....	62
<b>Eye Care</b> menu .....	65
<b>Color Mode</b> menu .....	67
<b>Audio</b> menu .....	70
<b>Custom</b> menu .....	71
<b>System</b> menu .....	73
<b>Troubleshooting</b> .....	77
Frequently asked questions (FAQ).....	77
Need more help?.....	81

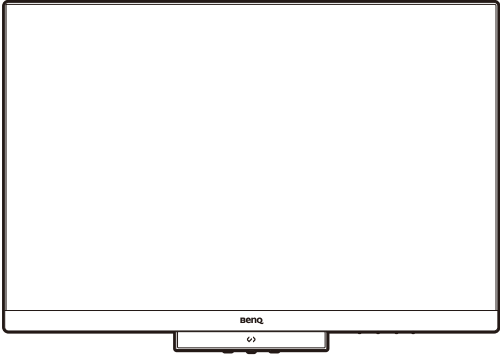
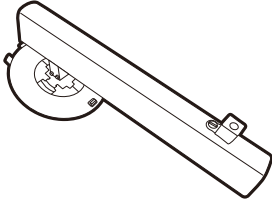
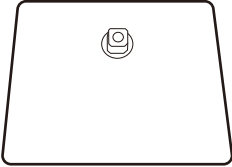
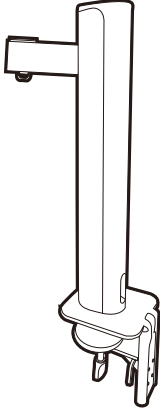
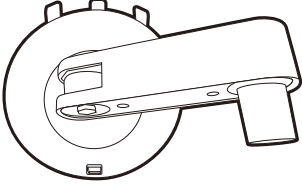
# Getting started

When unpacking please check you have the following items. If any are missing or damaged, please contact the place of purchase for a replacement.

BenQ LCD Monitor	
Monitor Stand (For models with stand)	
Monitor Base (For models with stand)	
Monitor Stand with C-clamp and Hex Key (For models with ergo arm stand)	
Upper arm with VESA plate (For models with ergo arm stand)	
Quick Start Guide	

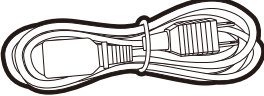
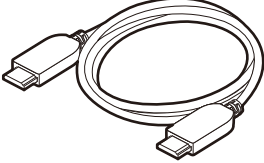
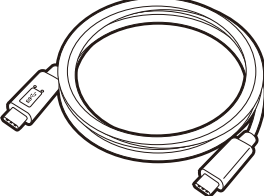
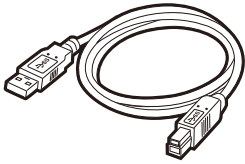
Safety Instructions	
Regulatory Statements	
Power Cord (Supplied item may differ by model or region.)	
Video Cable: HDMI	
USB Cable: USB-C™	
USB Cable: USB-B to USB-A	



- Available accessories and the pictures shown here may differ from the actual contents and the product supplied for your region. And the package contents may subject to change without prior notice. For cables that are not supplied with your product, you can purchase them separately.
- Consider keeping the box and packaging in storage for use in the future when you may need to transport the monitor. The fitted foam packing is ideal for protecting the monitor during transport.
- Accessories and cables may be included or sold separately depending on the product supplied for your region.



Always keep the product and accessories out of reach of small children.

# Getting to know your monitor

## Front view

RD240Q / RD280U(A)

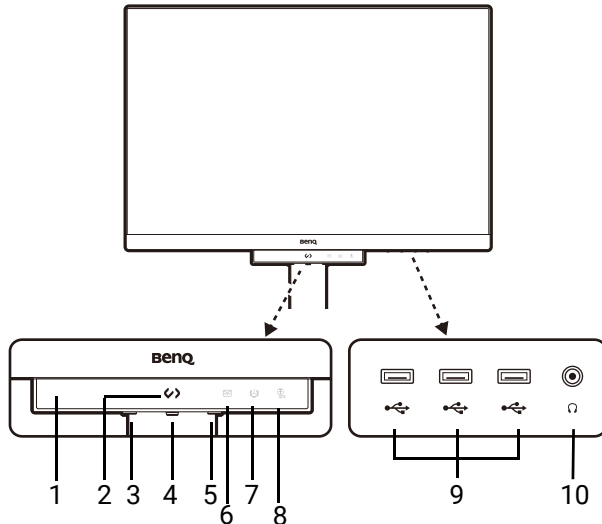

RD320U(A)

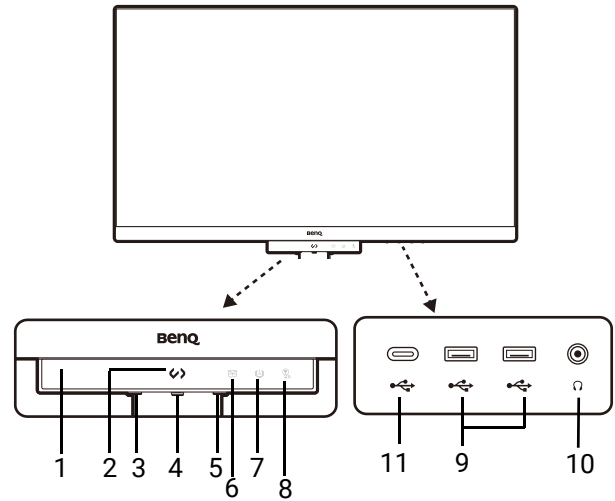

1. Proximity sensor / light sensor
2. Coding HotKey
3. Power button and power LED indicator
4. 5-way controller
5. Function key
6. Night Hours Protection LED indicator
7. B.I. Gen2 LED indicator
8. Low Blue Light Plus LED indicator
9. USB ports (downstream; connecting to USB devices)
10. Headphone jack
11. USB-C™ port (downstream; connecting to USB devices)

# Back view

RD240Q

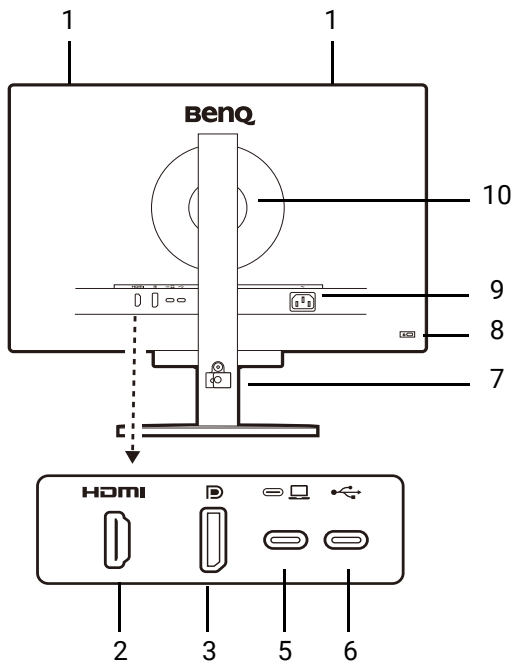

RD280U

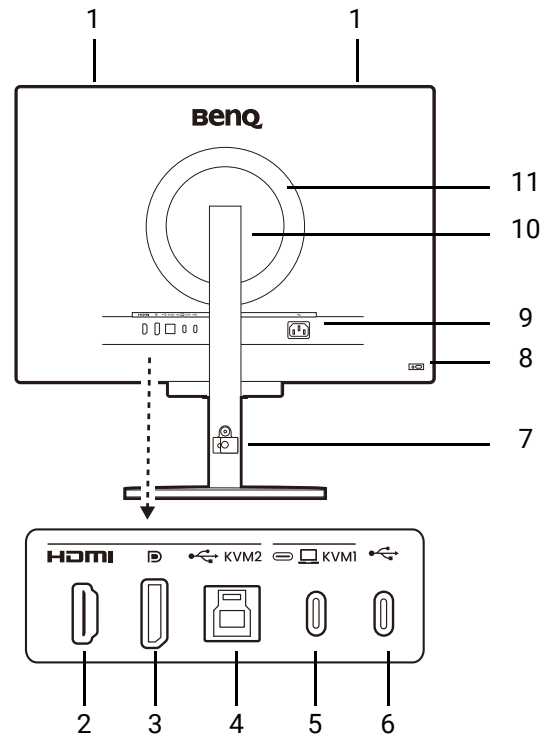

RD280UA

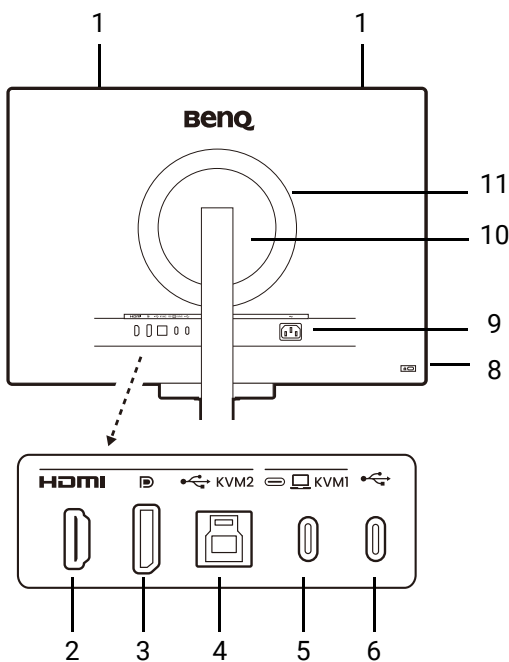

1. Speakers
2. HDMI socket
3. DisplayPort socket
4. USB 3.2 Gen1 Type-B port (upstream; connecting to the PC)
5. USB-C™ port (for video, data transfer and power delivery up to 90W)
6. USB-C™ port (for MST, data transfer and power delivery up to 7.5W)
7. Cable management
8. Kensington lock slot
9. AC power input jack
10. VESA cover
11. MoonHalo - LED light

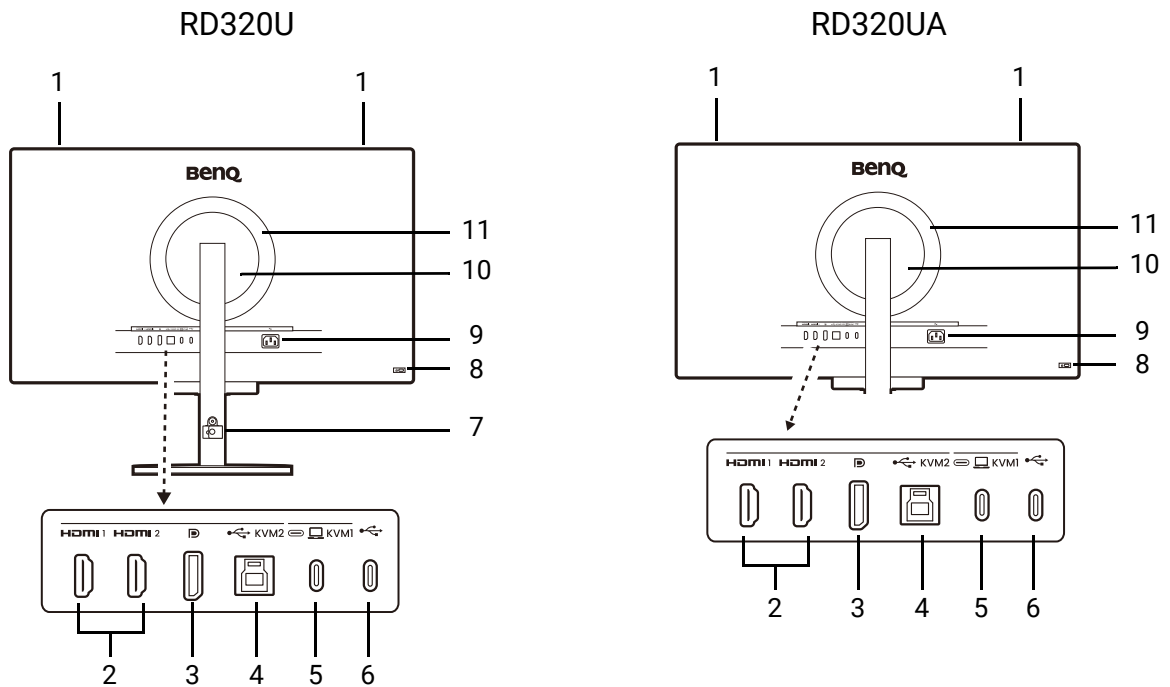

1. Speakers
2. HDMI socket
3. DisplayPort socket
4. USB 3.2 Gen1 Type-B port (upstream; connecting to the PC)
5. USB-C™ port (for video, data transfer and power delivery up to 90W)
6. USB-C™ port (for data transfer and power delivery up to 7.5W)
7. Cable management
8. Kensington lock slot
9. AC power input jack
10. VESA cover
11. MoonHalo - LED light



- Depending on the product specifications, the supported resolution and timing may vary.
- Above diagram may vary depending on the model.
- Picture may differ from product supplied for your region.
- (Applicable for products with white case) The case of the product may turn yellow in about 3 years due to the photo-oxidation reactions induced by light. This is a normal phenomenon and should not be considered as manufacturing defect.



# Connections

The following connection illustrations are for your reference only. For cables that are not supplied with your product, you can purchase them separately.

For detailed connection methods, see page 27 - 28.

RD240Q

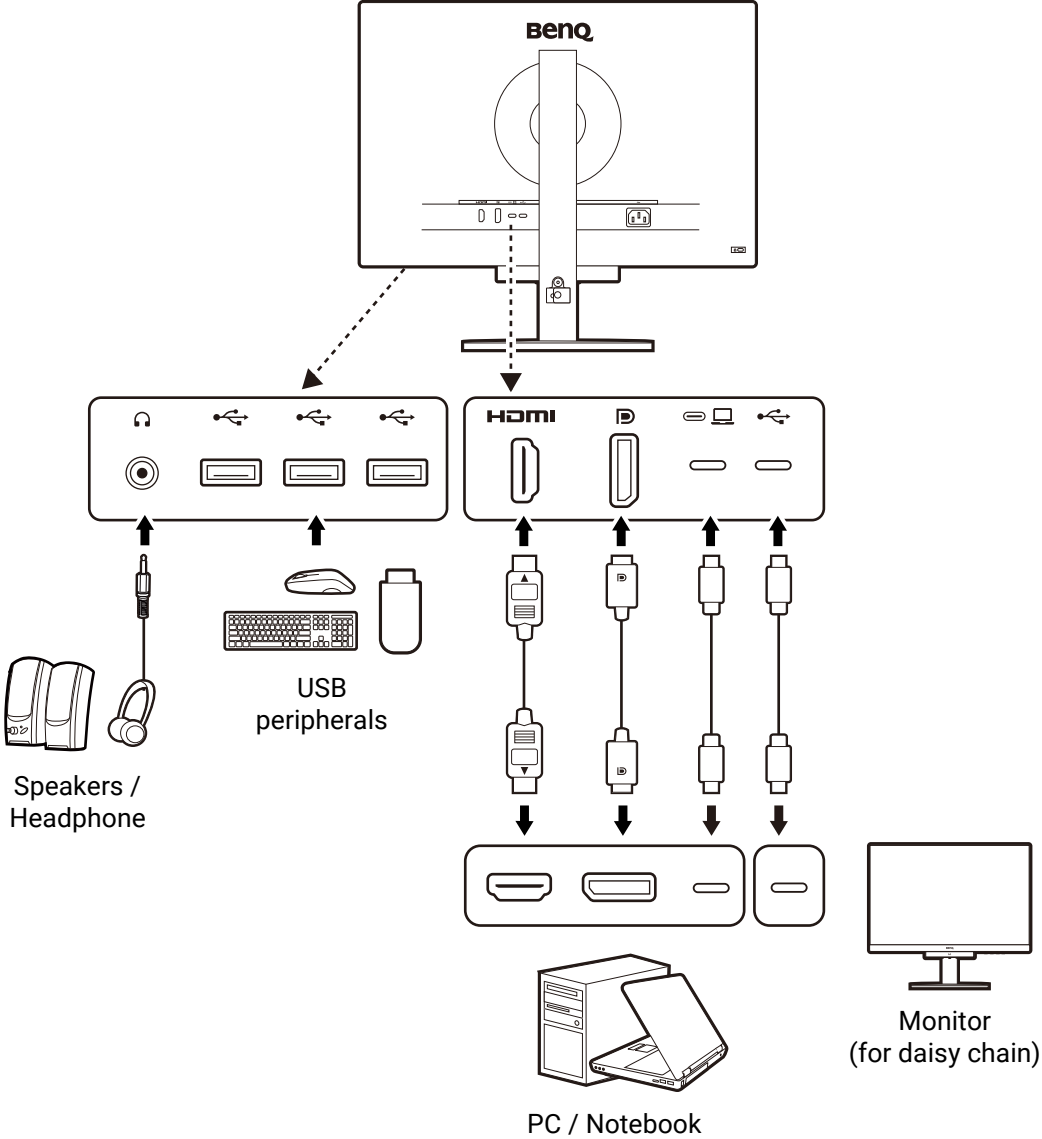

RD280U(A)

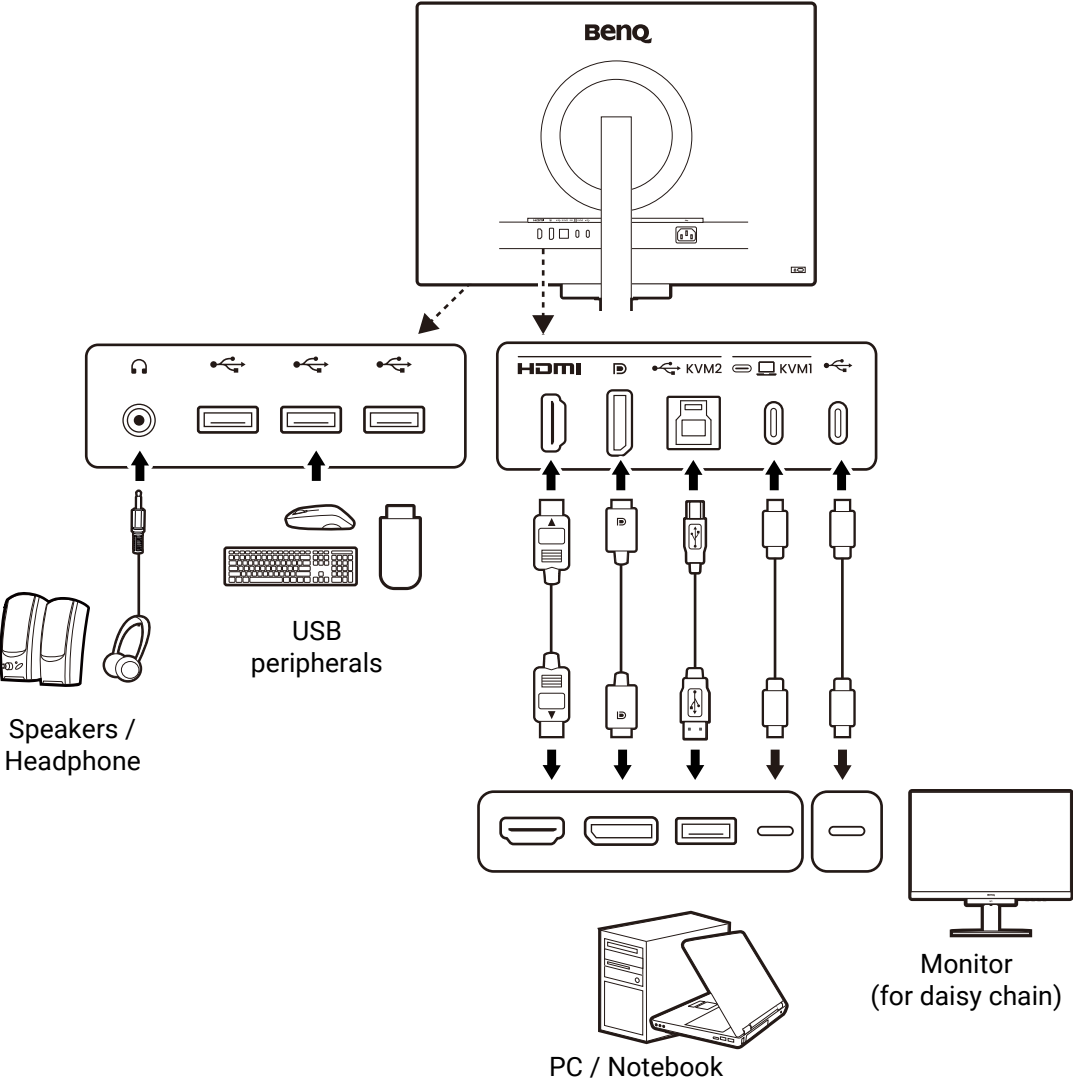

# RD320U(A)

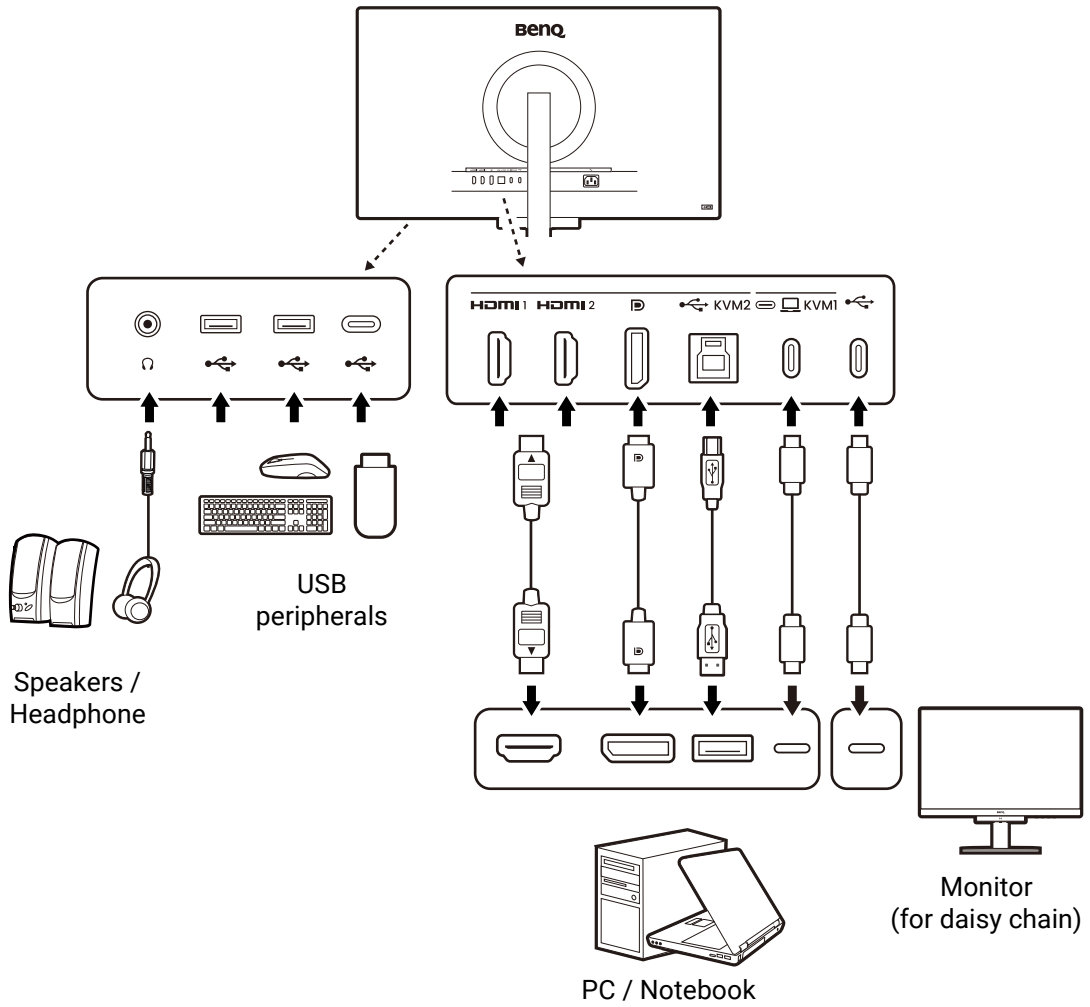

Due to USB-C™ technology limitation, the USB transmission speed is determined only by the selected refresh rate. See for [USB-C Configuration on page 75](#) more information.

## Power delivery of USB-C™ port on your monitor

With the power delivery function, your monitor helps supply power to the connected USB-C™ devices.

USB-C™ Power Delivery
5V / 3A
9V / 3A
12V / 3A
15V / 3A
20V / 4.5A

- A connected device needs to be equipped with a USB-C™ connector that supports charging function via USB power delivery.
- The connected device can be charged via USB-C™ port even when the monitor is in power saving mode. (\*)
- The USB power delivery is up to 90W. If the connected device requires more than 90W for operation or for boot up (when the battery is drained), use the original power adapter that came with the device.
- The information is based on the standard testing criteria and is provided for reference. The compatibility is not guaranteed as the user environments vary. If a separately purchased USB-C™ cable is used, make sure the cable is certified by USB-IF and is full-featured, with power delivery and video / audio / data transfer functions.



\*: Charging via USB-C™ in monitor power saving mode is available when the **Power Awake** function is enabled. Go to **System > Power Awake** and select **ON**.

---

# How to assemble your monitor hardware (for models with stand)



- If the computer is turned on you must turn it off before continuing. Do not plug-in or turn-on the power to the monitor until instructed to do so.
- The following illustrations are for your reference only. The location and available input and output jacks may vary depending on the purchased model.



Avoid finger pressure on the screen surface.



Never stand your monitor on a desk or floor without its stand arm and base. The controls on the bottom of the front bezel are not designed to hold the weight of the monitor and may be damaged.

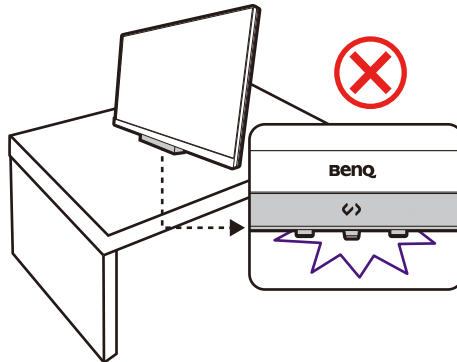

## 1. Attach the monitor base.



Please be careful to prevent damage to the monitor. Placing the screen surface on an object like a stapler or a mouse will crack the glass or damage the LCD substrate voiding your warranty. Sliding or scraping the monitor around on your desk will scratch or damage the monitor surround and controls.

Protect the monitor and screen by clearing a flat open area on your desk and placing a soft item like the monitor packaging bag on the desk for padding.

Gently lay the screen face up on a flat clean padded surface.

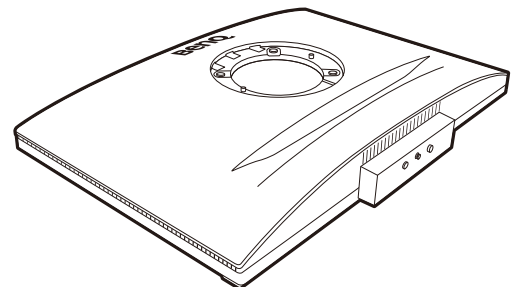

Attach the monitor stand to the monitor base as illustrated.

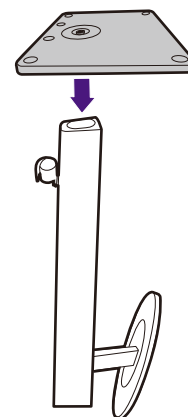

Raise the thumbscrew lid on the bottom of the monitor stand (1) and tighten the thumbscrew as illustrated(2).

Push the lid back.

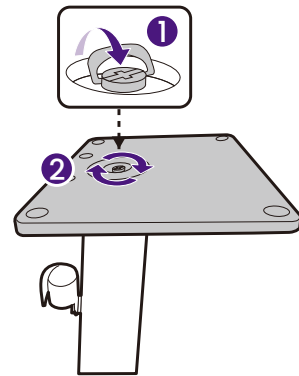

Orient and align the stand arm with the monitor (1), push them together until they click and lock into place (2).

Gently attempt to pull them back apart to check that they have properly engaged.

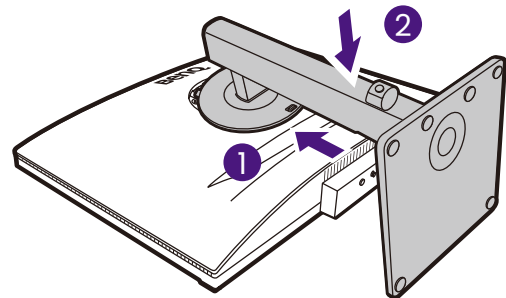

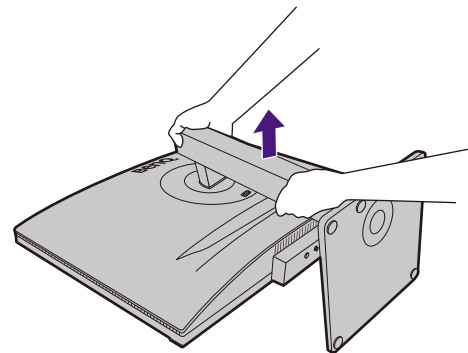

Carefully lift the monitor, turn it over and place it upright on its stand on a flat even surface. Always hold the monitor from its handle.

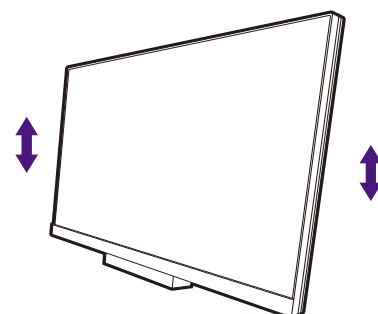

You might want to adjust the monitor stand height. See [Adjusting the monitor angle on page 40](#) for more information.

 Your monitor is an edge-to-edge monitor and should be handled with care. Avoid finger pressure on the screen surface and touch bar. Adjust the screen angle by placing your hands on the top and on the bottom of the monitor as illustrated.



 You should position the monitor and angle the screen to minimize unwanted reflections from other light sources.

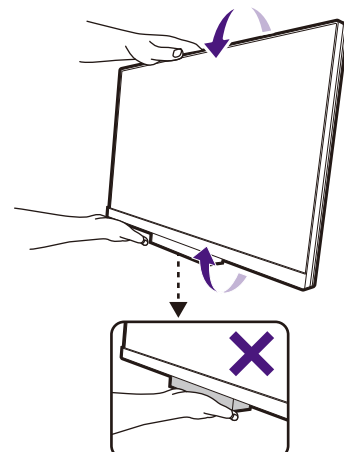

## 2. Connect the PC video cable



The video cables included in your package and the socket illustrations on the right may vary depending on the product supplied for your region.



Use a latchless DP cable for easy connections.

### 1. Establish a video cable connection.

- Connect the plug of the HDMI cable to the HDMI port on the monitor.
- Connect the plug of the DP cable to the monitor video socket.
- Connect the plug of the supplied USB-C™ cable to the USB-C™ port on the monitor.

RD240Q

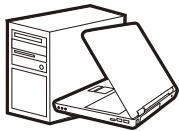
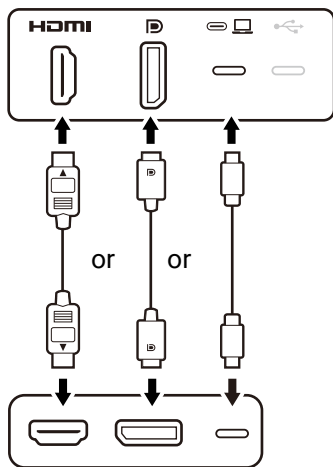

RD280U(A)

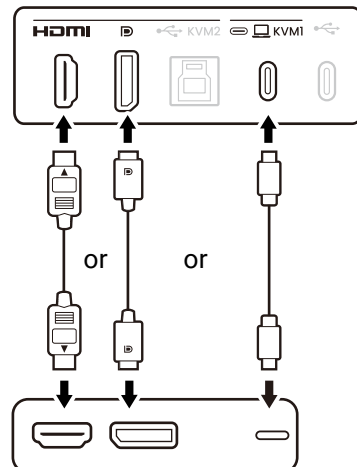

RD320U(A)

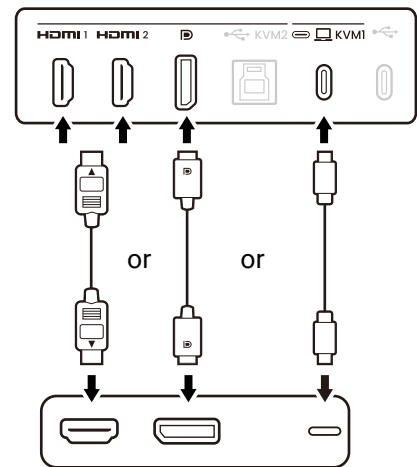

2. Connect the other end of the video cable to an appropriate port of a digital output source (e.g. a computer).

### 3. Connect the headphone.

You may connect the headphones to the headphone jack found below the lower-right of the front bezel.

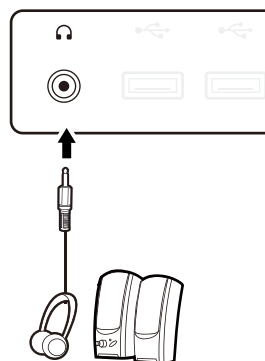

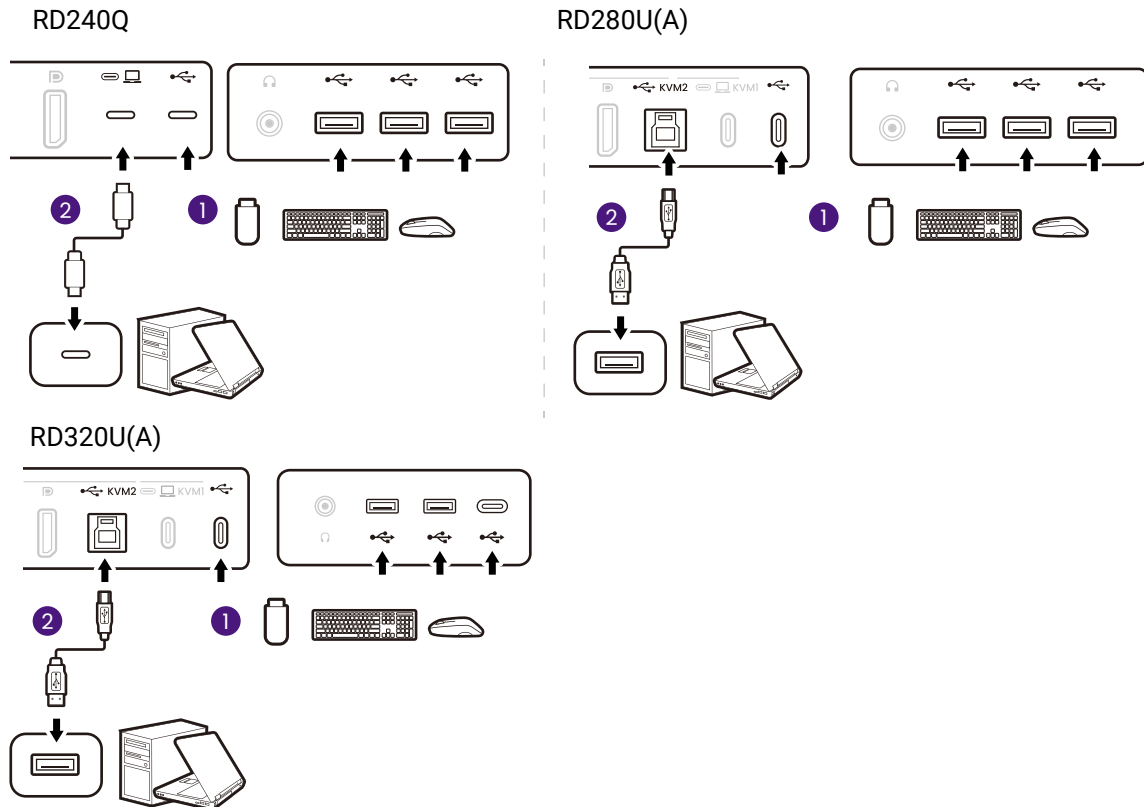

## 4. Connect the USB devices.

1. Connect the USB devices via other USB ports (downstream) on the monitor. These downstream USB ports transmit data between the connected USB devices and the upstream port.
2. Connect the USB cable between the PC and the monitor (via the upstream USB port). This upstream USB port transmits data between the PC and the USB devices connected to the monitor. Note that this step is not required if the video source is from the Thunderbolt™ 3 or USB-C™ inputs.



## 5. Connect the power cable.

1. Plug one end of the power cord into the socket labelled  on the rear of the monitor.
2. Plug the other end of the power cord into a power outlet.

 When plugging the power cord, please refrain from touching the Coding HotKey and Function Bar. If Coding HotKey does not work after power on, please unplug and try connecting again.

 Picture may differ from product supplied for your region.

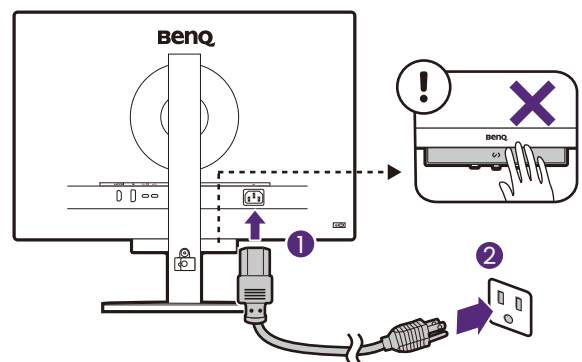



## 6. Organize the cables.

Route the cables via the cable strap.



The cable strap can hold up to 6 cables including the power cord. Please avoid pulling the cable strap too tightly or forcefully to prevent it from breaking accidentally.

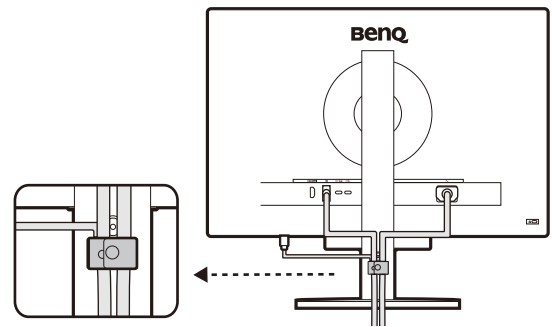

## 7. Turn on the power.

Turn on the monitor by pressing the power button on the monitor.

Turn on the computer too.



To extend the service life of the product, we recommend that you use your computer's power management function.

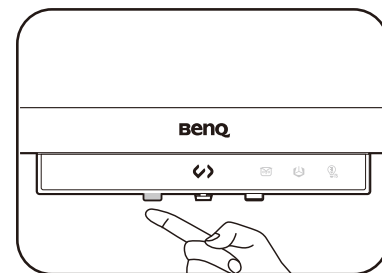

# How to detach the stand (for models with stand)

## 1. Prepare the monitor and area.

Turn off the monitor and the power before unplugging the power cable. Turn off the computer before unplugging the monitor signal cable.

Protect the monitor and screen by clearing a flat open area on your desk and placing a soft item like a towel on the desk for padding, before laying the screen face down on a flat clean padded surface.



Please be careful to prevent damage to the monitor. Placing the screen surface on an object like a stapler or a mouse will crack the glass or damage the LCD substrate voiding your warranty. Sliding or scraping the monitor around on your desk will scratch or damage the monitor surround and controls.

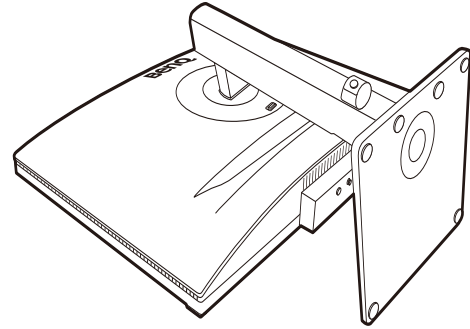

## 2. Remove the monitor stand.

Push the quick release button (1) to release the monitor. Then, detach the stand from the monitor (2 and 3).

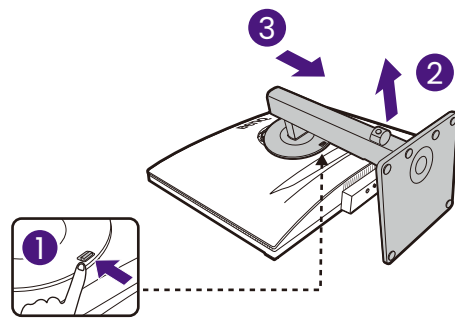

## 3. Remove the monitor base.

Release the thumbscrew on the bottom of the monitor base.

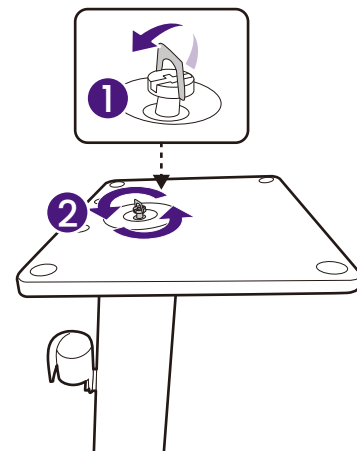

And then detach the base from the stand.

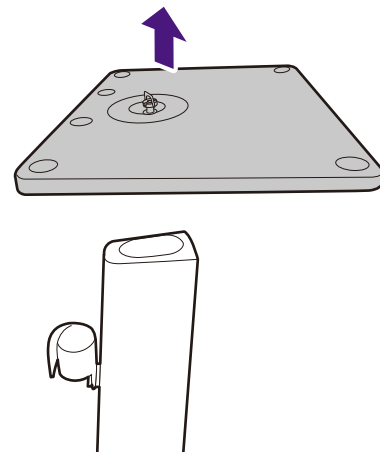

# How to assemble your monitor hardware (for models with ergo arm stand)



- The ergo arm stand has been adjusted and tested to support the weight of the bundled monitor to provide smoothness and stability. To avoid possible personal injury or damage to the monitor, do not attach the ergo arm stand to other monitors.
- If the computer is turned on you must turn it off before continuing. Do not plug-in or turn-on the power to the monitor until instructed to do so.
- The following illustrations are for your reference only. The location and available input and output jacks may vary depending on the purchased model.



Avoid finger pressure on the screen surface.

## Mounting options

Depending on your desk type, follow the steps below to assemble your monitor.

### A. Clamp mounting

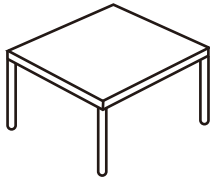

1. Prior to assembling
2. Adjust screw location for thinner desk (optional)
3. Install ergo arm for clamp mounting
4. Continue with [Mount the monitor head](#) to complete the hardware assembly.

### B. Grommet mounting

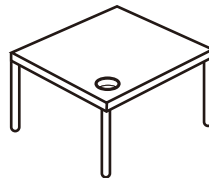

1. Prior to assembling
2. Install ergo arm for grommet mounting
3. Continue with [Mount the monitor head](#) to complete the hardware assembly.

## Prior to assembling

### 1. Check where to install the arm.

The desk should be placed on a flat even area and should be stable enough to hold the weight of the ergo arm stand and the monitor.

The ergo arm stand works for clamp and grommet mounting to suit your need. Make sure there is enough room for height and articulation adjustments.

Make sure the arm is fixed to a flat desk area without a grommet ring and a protrusion.

#### A. Clamp mounting

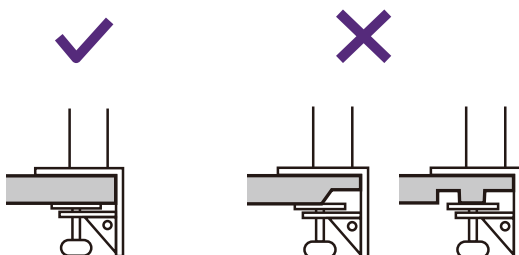

#### B. Grommet mounting

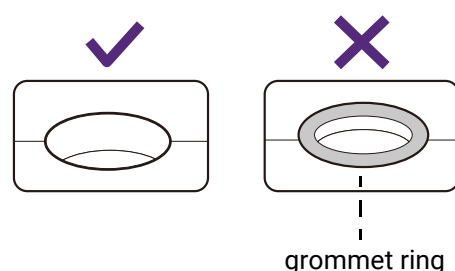

## 2. Check desk thickness.

Depending on the desk thickness, you can change the location of the screws that fix the C-clamp. See [Adjust screw location for thinner desk \(optional\)](#) for details.

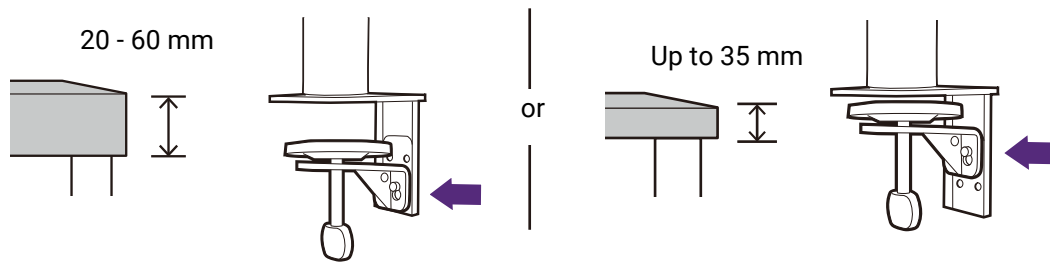

### Adjust screw location for thinner desk (optional)

1. Use the provided Hex Key to half-release the screws that fix the C-clamp.

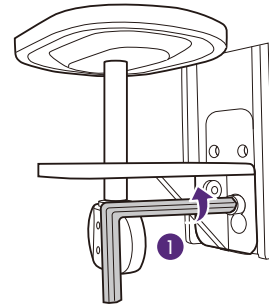
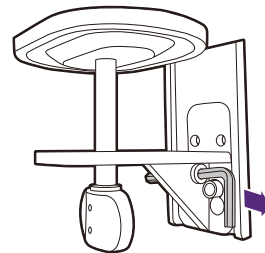

2. Lift the C-clamp up and detach it.

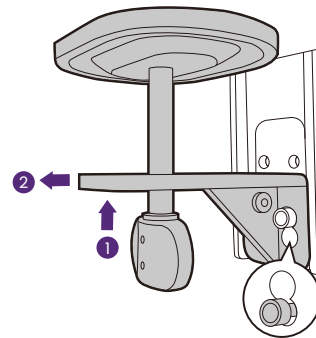

3. Release the screws completely so you can tighten them to the other set of screw holes.

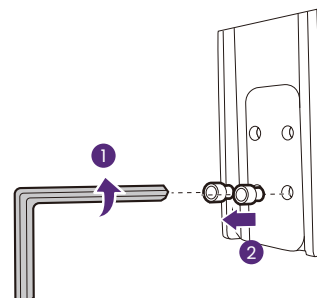

4. Half-fix the screws to the other set of screw holes.

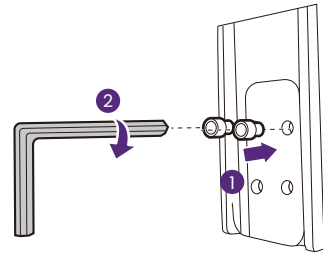

5. Attach the C-clamp to the screws.

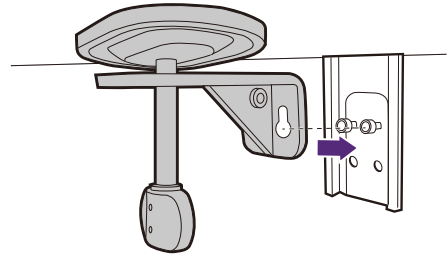

6. Tighten the screws.

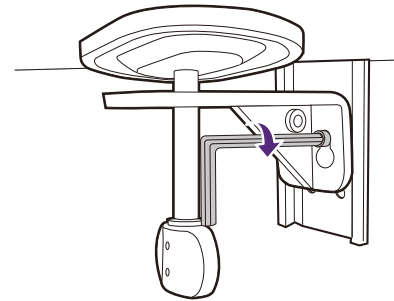

# Setup

## 1. Install ergo arm

### Install ergo arm for clamp mounting

- a. Attach the stand arm to the edge of the desk.

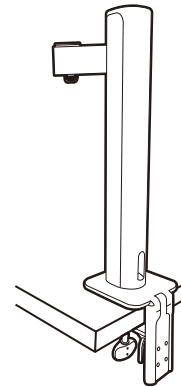

- b. Turn the handle counterclockwise to fix it to the desk.

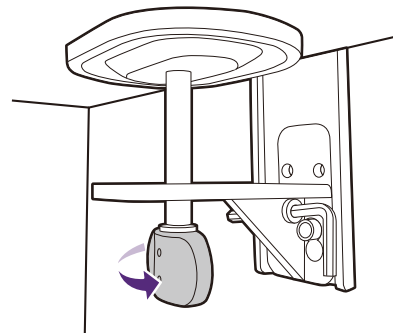

### Install ergo arm for grommet mounting

- a. Use the provided Hex Key to half-release the screws that fix the C-clamp.

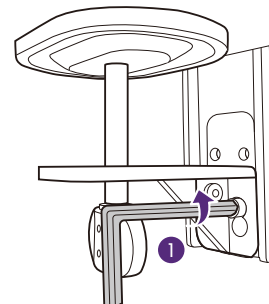

- b. Lift the C-clamp up and detach it.

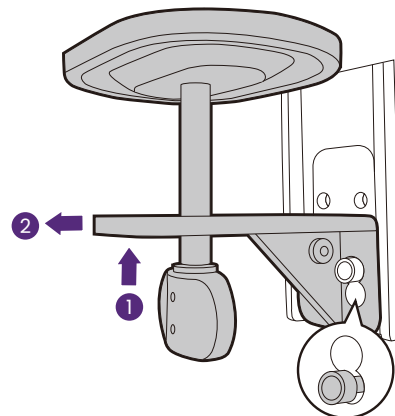

- c. Depending on your desk thickness, you may need to change the location of the screws as instructed from step 3 to step 4 in [Adjust screw location for thinner desk \(optional\)](#).
- d. Install the stand to a desired place. Make sure there is no grommet ring as the stand needs to be fixed on a flat surface.

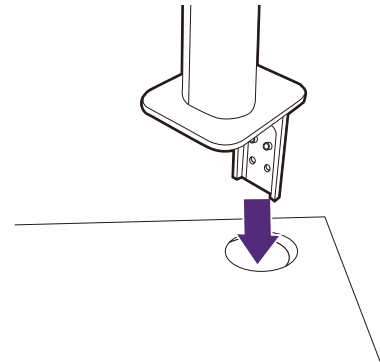

- e. Attach the C-clamp to the stand and tighten the screws.

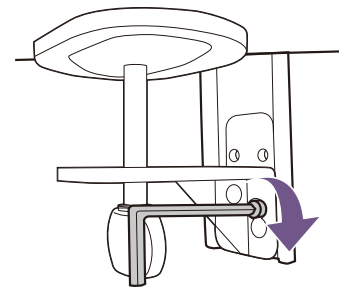
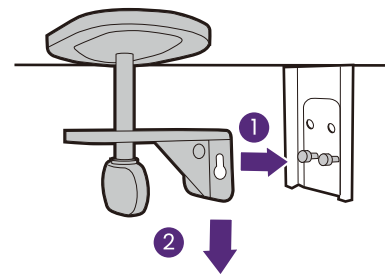

- f. Turn the handle counterclockwise to fix it to the desk.

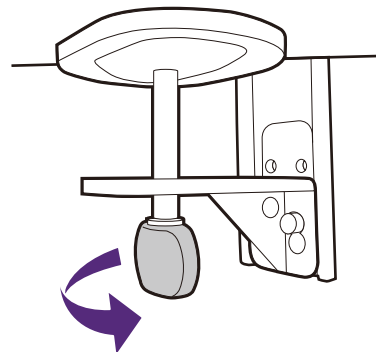

## 2. Mount the monitor head

Keep the monitor head in the packaging to prevent damage to the monitor.

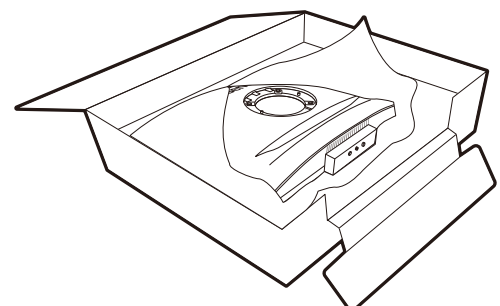

Attach the upper arm to the monitor as illustrated until it locks in place.

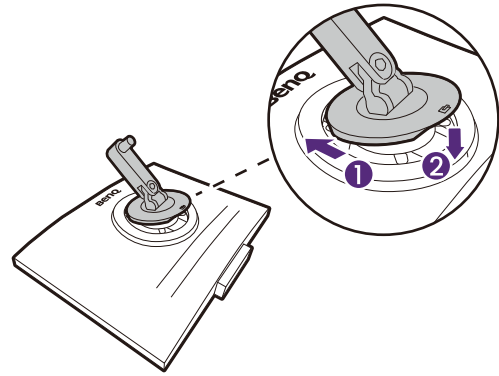

Carefully lift the monitor.

**!** Never stand your monitor on a desk or floor without its stand arm and base. The controls on the bottom of the front bezel are not designed to hold the weight of the monitor and may be damaged.

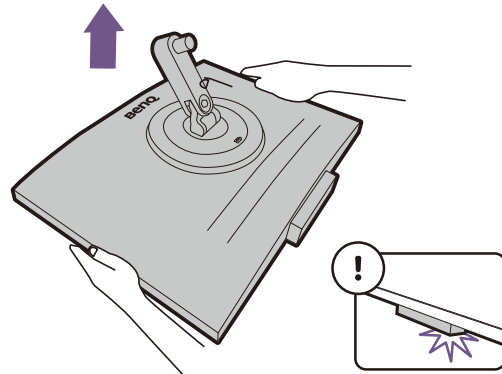

Align the upper arm with the monitor stand and place it properly without the metal part being seen.

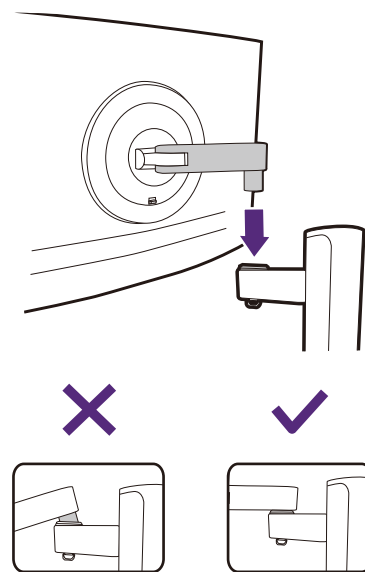

Raise the thumbscrew lid and tighten the thumbscrew as illustrated. Then push the lid back.

If the upper arm is attached properly in the previous step, you will be able to tighten the thumbscrew.

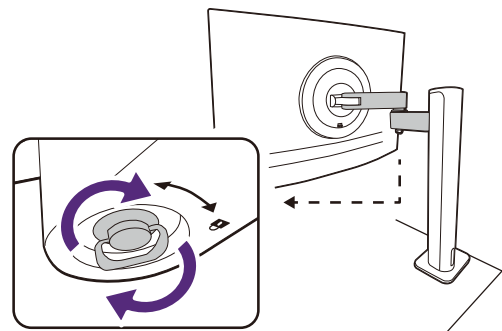



You might want to adjust the monitor stand height. See [Adjusting the monitor angle on page 40](#) for more information.

- ! Your monitor is an edge-to-edge monitor and should be handled with care. Avoid finger pressure on the screen surface and touch bar. Adjust the screen angle by placing your hands on the top and on the bottom of the monitor as illustrated.
- 💡 You should position the monitor and angle the screen to minimize unwanted reflections from other light sources.

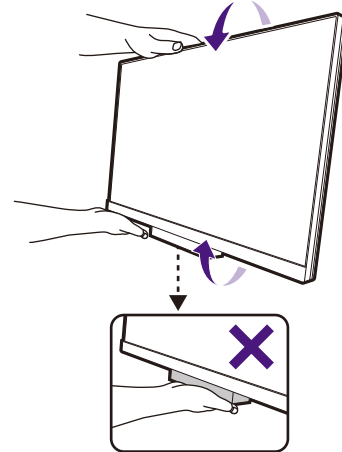
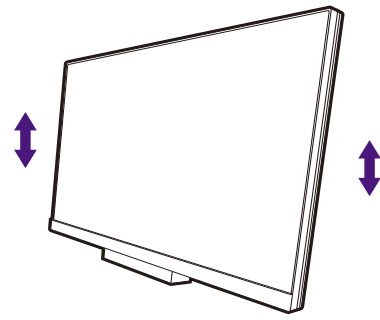

### 3. Connect and organize the cables

Detach the cable management cover.

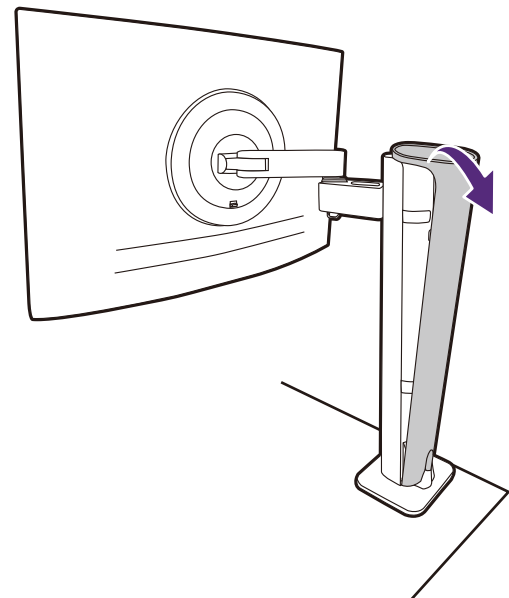

Connect and organize the cables properly. See [page 27](#) to [page 28](#) for connections.

Remember to leave slack in cables (near the monitor) to prevent connectors from being pulled out inappropriately during monitor tilt or arm moves.

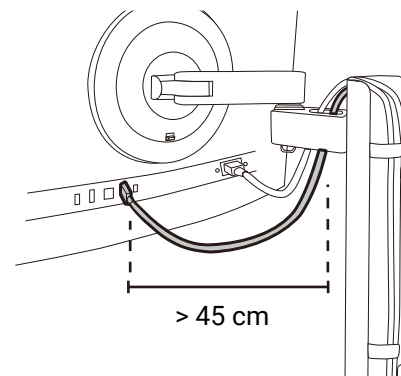

Put the cable management cover back.

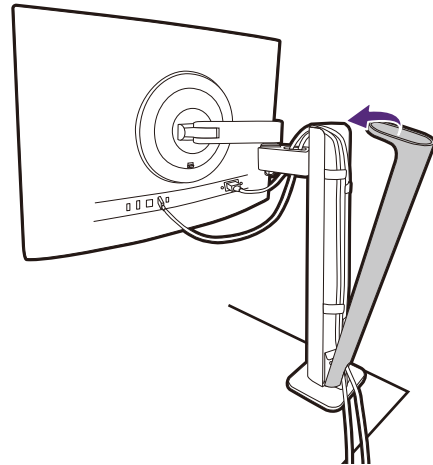

#### 4. Connect-to and turn-on the power

Plug the other end of the power cord into a power outlet and turn it on.

 Picture may differ from product supplied for your region.

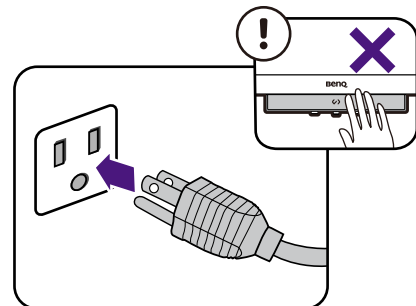

Turn on the monitor by pressing the power button on the monitor.

Turn on the computer, too.

 To extend the service life of the product, we recommend that you use your computer's power management function.

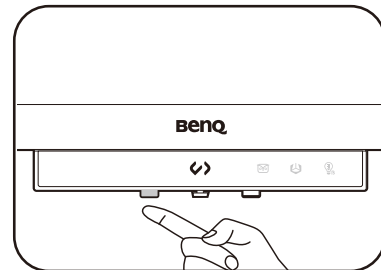

# How to detach the stand (for models with ergo arm stand)

## 1. Prepare the monitor and area.

Turn off the monitor and the power before unplugging the power cable. Turn off the computer before unplugging the monitor signal cable.

## 2. Unplug all cables.

Remove cable management cover. Unplug all cables carefully.

Put the cable management cover back.

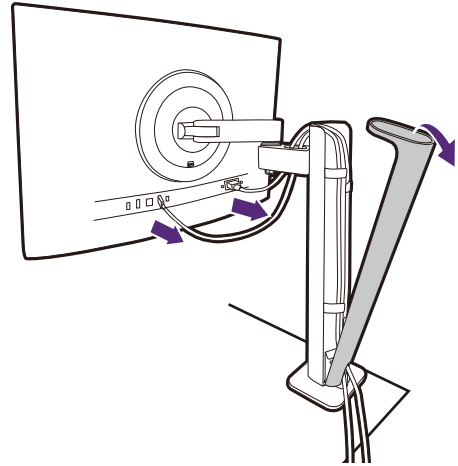

## 3. Detach the monitor.

Push the quick release button to release the monitor, and lift to detach the monitor.

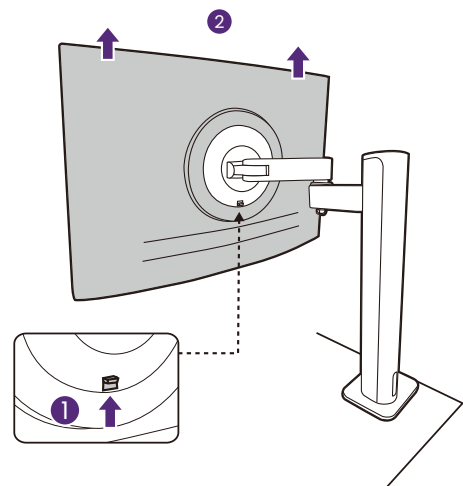

## 4. Remove the ergo arm stand.

Release the screws to remove the upper arm and the ergo arm stand as illustrated.



If the monitor stand is removed for wall mounting, see [Using the monitor wall mounting kit \(purchased separately\) on page 42](#) and the instruction manual of your wall mount bracket (purchased separately) for more information.

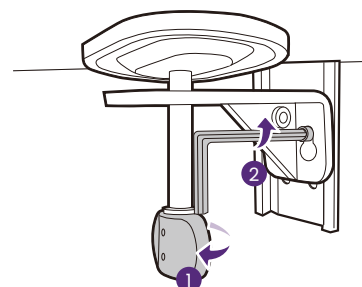
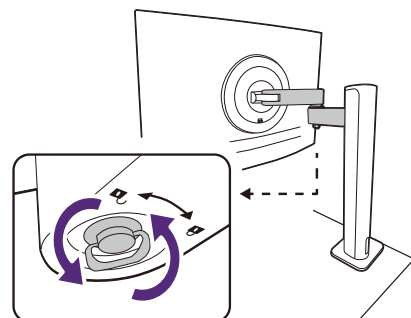

# Adjusting the monitor angle

## Adjusting the monitor height

To adjust the monitor height, hold both the left and the right sides of the monitor to lower the monitor or lift it up to the desired height.

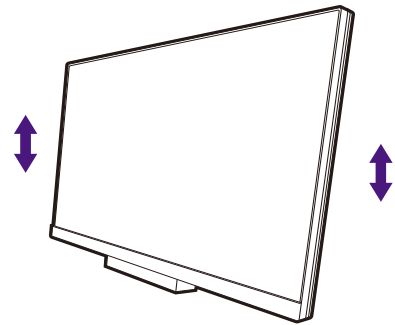

- Avoid placing hands on the upper or lower part of the height-adjustable stand or at the bottom of the monitor, as ascending or descending monitor might cause personal injuries. Keep children out of reach of the monitor while performing this operation.

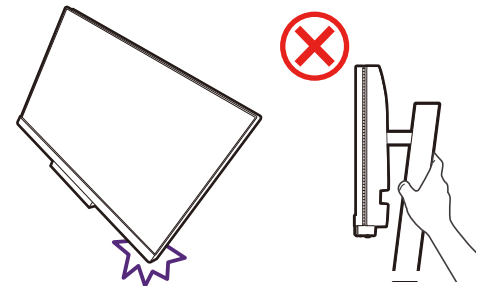

- If the monitor has been rotated to portrait mode and height adjustment is desired, you should be noted that the wide screen will keep the monitor from being lowered to its minimum height. If you have placed anything on the base cover, remove them before monitor pivot.

## Rotating the monitor (selected models only)

### 1. Pivot the display.

Before rotating the monitor with a portrait viewing orientation, the display has to be rotated 90 degrees.

Right-click the desktop and select **Screen resolution** from the popup menu. Select **Portrait in Orientation**, and apply the setting.



Depending on the operating system on your PC, different procedures should be followed to adjust the screen orientation. Refer to the help document of your operating system for details.

### 2. Adjust the cables.

- For HAS stand, unsnap the cable strap to avoid cables from tangling.
- For ergo arm, leave slack in cables (near the monitor) to prevent connectors from being pulled out inappropriately during monitor tilt or arm moves.

### 3. Fully extend the monitor and tilt it.

Gently lift the display up and extend it to the maximum extended position. Then tilt the monitor.



The monitor should be vertically extended to allow to rotate from landscape to portrait mode.

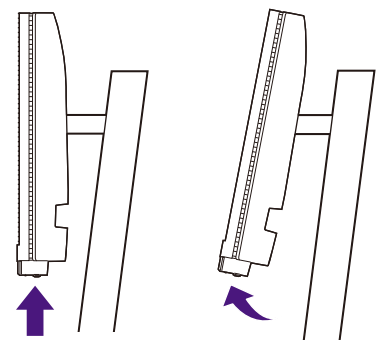

## 4. Rotate the monitor

Applicable angle of rotation:

- RD240Q: 90 degrees clockwise or counterclockwise
- RD280UA/RD320U(A): 90 degrees clockwise
- RD280U: Not applicable



- For users needing screen pivoting, consider the RD240Q/RD280UA/RD320U/RD320UA models.
- If RD280U(A)/RD320U(A) is used with any non-RD monitor arms, only clockwise rotation is recommended for optimal performance.
- To avoid the edge of the LCD display hitting the monitor base surface while it is being rotated, do tilt and extend the monitor to the highest position before you start to rotate the display. You should also make sure there are no obstacles around the monitor and there is enough room for cables. Remove the items placed on the monitor base, the connected USB peripherals and cables first.

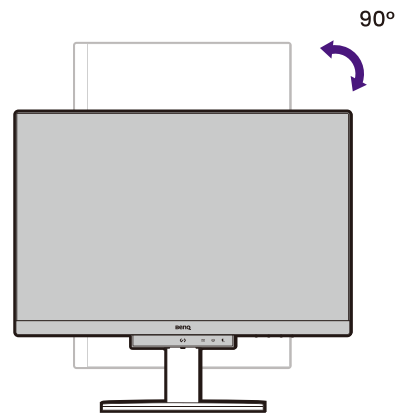

## 5. Adjust the monitor to the desired viewing angle.

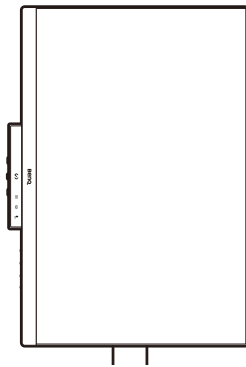

## 6. Organize the cables.

- For HAS stand, see [Organize the cables](#).
- For ergo arm, see [Connect and organize the cables](#)

## Viewing angle adjustment

You may position the screen to the desired angle with monitor tilt, swivel, and height adjustment functions. Check the product specifications on the website for details.

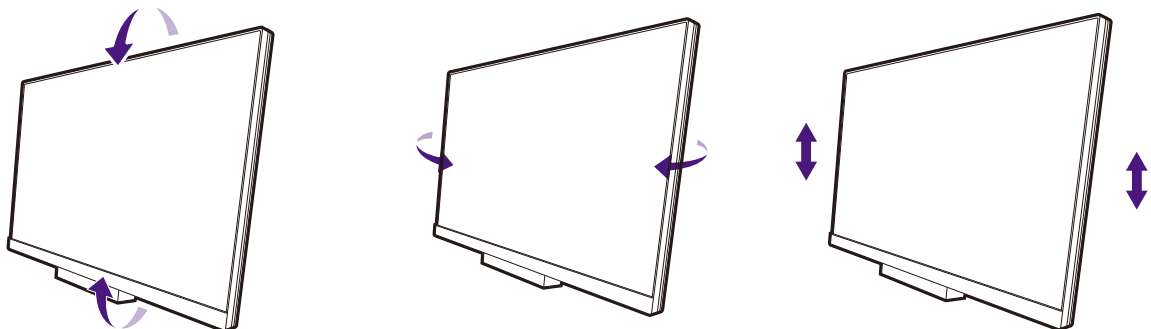

## Using the monitor wall mounting kit (purchased separately)

The back of your LCD monitor has a VESA standard mount with 100mm pattern, allowing the installation of a wall mount bracket. Before starting to install a monitor wall mounting kit, please read the precautions carefully.

### Precautions

- Install your monitor and monitor mounting kit on a wall with flat surface.
- Ensure that the wall material and the standard wall mount bracket (purchased separately) are stable enough to support the weight of the monitor. Refer to the product specifications on the website for weight information.
- Turn off the monitor and the power before disconnecting the cables from the LCD monitor.

#### 1. Remove the monitor stand.

Lay the screen face down on a clean and well-padded surface. Detach the monitor stand as instructed.

- [How to detach the stand \(for models with stand\) on page 30](#)
- [How to detach the stand \(for models with ergo arm stand\) on page 39](#)

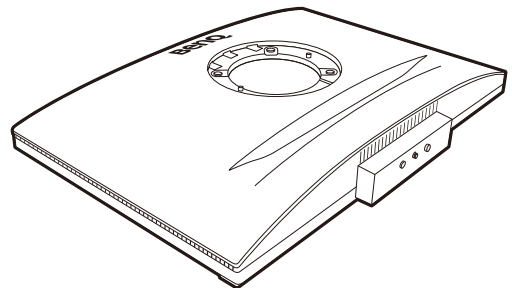

#### 2. Remove the screws on the back cover.

Use a cross-pointed screwdriver to release the screws on the back cover. The use of a magnetic-head screwdriver is recommended to avoid losing the screws.

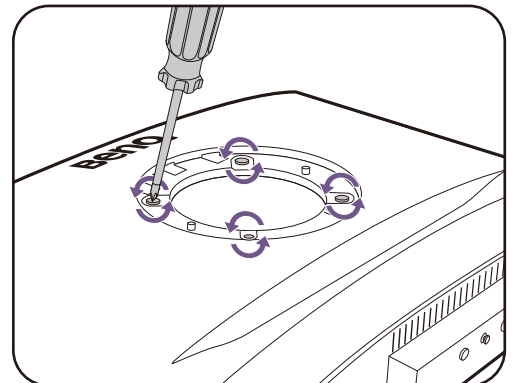

- In case you intend to use your monitor on the stand in the future, please keep the monitor base, monitor stand, and screws somewhere safe for future use.

#### 3. Follow the instruction manuals of the wall mount bracket you purchased to complete the installation.

- Use four M4 x 10 mm screws to fix a VESA standard wall mount bracket to the monitor. Make sure that all screws are tightened and secured properly. Consult a professional technician or BenQ service for wall mount installation and safety precautions.

# How to adjust your monitor

## The function bar

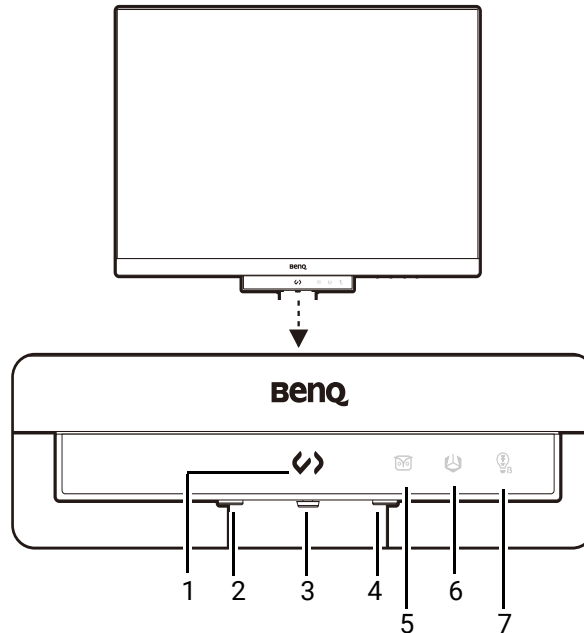





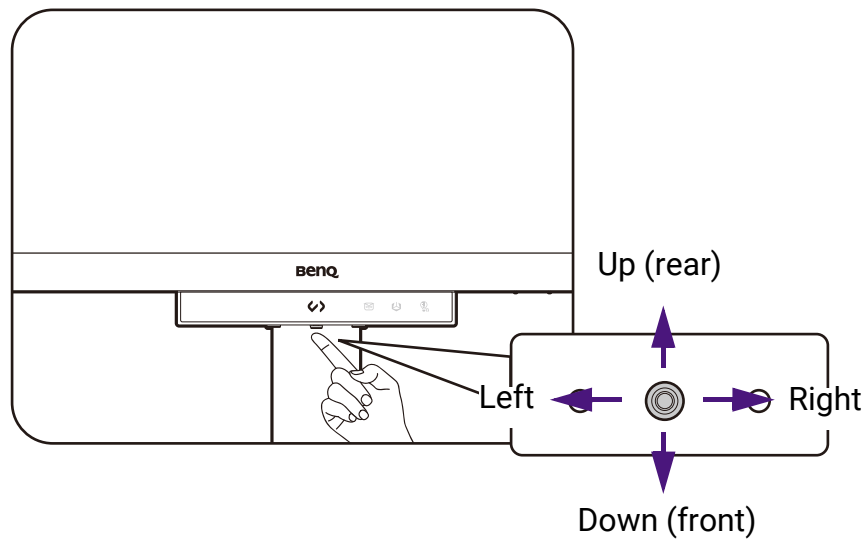

No.	Name	Description
1.	Coding HotKey	Toggles among different color modes for coding. See <a href="#">Working with Quick Menu on page 46</a> for more information.
2.	Power key	Turns the power on or off.
3.	5-way controller	Accesses the functions or menu items as instructed by the on-screen icons. See <a href="#">5-way controller and basic menu operations on page 44</a> for more information.
4.	Function key	<ul style="list-style-type: none"><li>• By default, the key is the hot key for <b>Input</b>.</li><li>• Go to <b>Custom &gt; Function Key</b> to access the Function Key setting menu. See <a href="#">Customizing the Function Key on page 45</a> for more information.</li></ul>
5.	Night Hours Protection LED indicator	<ul style="list-style-type: none"><li>• Lights up if the function is enabled.</li></ul>
6.	B.I. Gen2 LED indicator	<ul style="list-style-type: none"><li>• Go to <b>Coding Booster &gt; Function Bar &gt; LED Indicator</b> to adjust the LED behavior. See <a href="#">LED Indicator on page 62</a> for more information.</li></ul>
7.	Low Blue Light Plus LED indicator	

## 5-way controller and basic menu operations

The 5-way controller is located below the lower part of the front bezel. While sitting in front of the monitor, move the controller to the directions instructed by the on-screen icons for menu navigation and operations.



OSD icon	5-way controller operation	Function
(When no menu has been activated)		
N/A	Press the 5-way controller	Activates the main menu.
	Press left/right (Selected models only)	Brings up <b>Quick Menu</b> for <b>MoonHalo</b> . See <a href="#">Working with Quick Menu for MoonHalo (selected models only)</a> on page 47 for more information.
(When a menu has been activated)		
	Press	Confirms the selection.
	Move to the right	<ul style="list-style-type: none"> <li>• Enters sub menus.</li> <li>• Confirms the selection.</li> </ul>
	Move up	<ul style="list-style-type: none"> <li>• Goes to the previous menu item.</li> <li>• For up / increase adjustment.</li> </ul>
	Move down	<ul style="list-style-type: none"> <li>• Goes to the next menu item.</li> <li>• For down / decrease adjustment.</li> </ul>
	Move to the left	<ul style="list-style-type: none"> <li>• Returns to the previous menu.</li> <li>• Exits OSD menu.</li> </ul>



All OSD (On Screen Display) menus can be accessed by the control keys. You can use the OSD menu to adjust all the settings on your monitor. Available menu options may vary depending on the input sources, functions and settings.

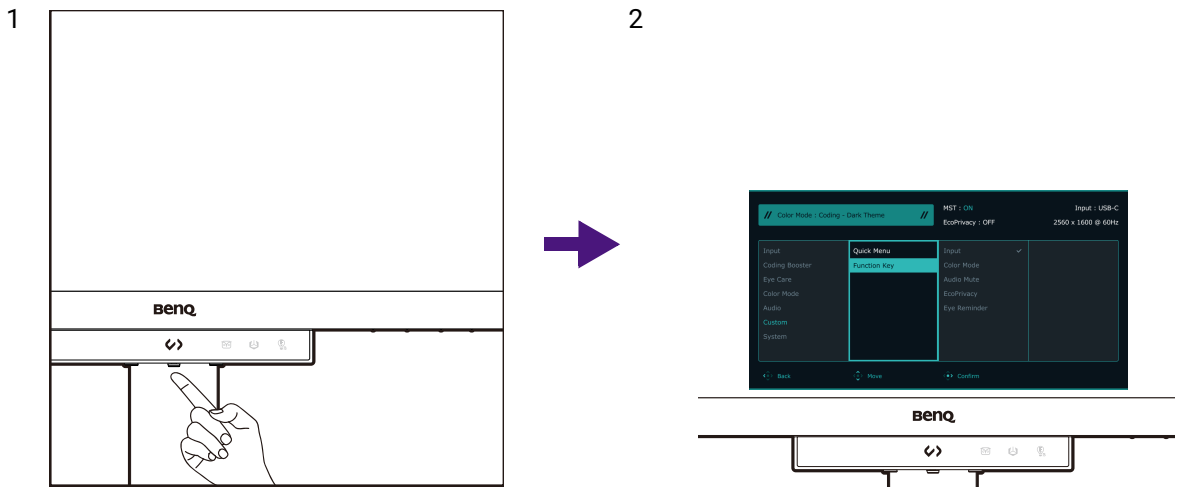

1. Press  to bring up the main menu.
2. On the main menu, follow the on-screen icons on the bottom of the menu to make adjustments or selection. See [Navigating the main menu on page 57](#) for details on the menu options.

## Customizing the Function Key

1. Go to **Menu > Custom > Function Key** to access the Function Key setting menu.
2. In the sub menu, select a function that can be accessed by this key. A pop-up message will appear, showing that the setup is complete.

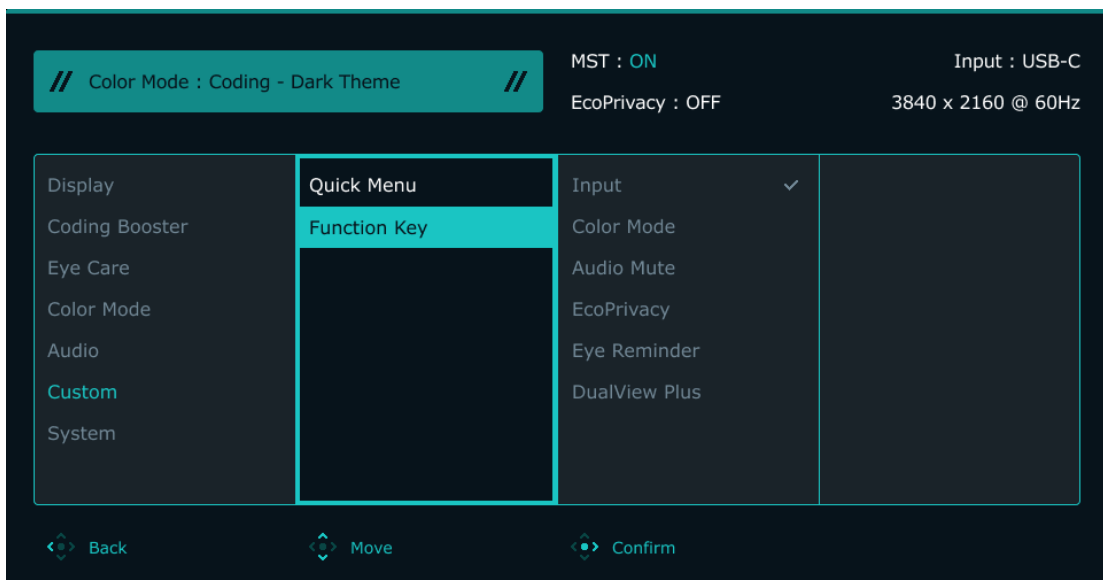

## Working with Quick Menu

The **Quick Menu** is a quick access to different color modes for coding and to change monitor settings frequently adjusted.

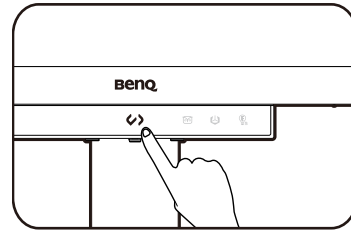

### 1. Bring up Quick Menu.

Tap  (Coding HotKey).



### 2. Cycle through different coding modes.

Use either option below:

- Tap  (Coding HotKey) again.
- Press  / .

a.

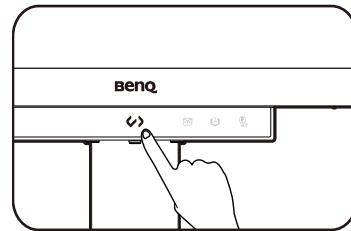



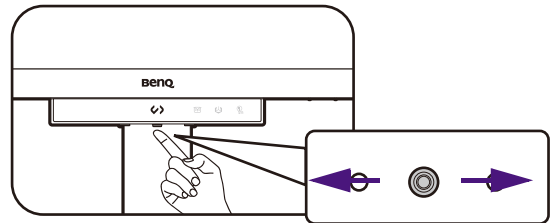

b.



Coding mode options:

- **Coding - Dark Theme**
- **Coding - Light Theme**
- Last selected color mode

### 3. Adjust color mode settings

- Press  /  to access different setting options.
- Press  /  to make adjustments.



If the **Night Hours Protection** settings is grayed out, see [Night Hours Protection is grayed out in Quick menu. on page 80](#) for more information.

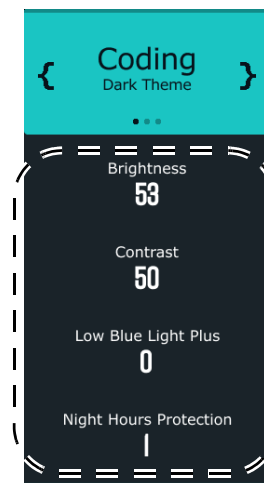



## Customizing Quick Menu options

1. Press  to bring up the main menu.
2. Go to **Custom > Quick Menu**.
3. In the sub menu, choose 2 to 4 options to be accessed by the Quick Menu. See [Quick Menu on page 71](#) for all the available options.

## Working with **Quick Menu** for **MoonHalo** (selected models only)



The **Quick Menu** for **MoonHalo** is a quick access to adjust **MoonHalo** settings.

### 1. Bring up **Quick Menu** for **MoonHalo**

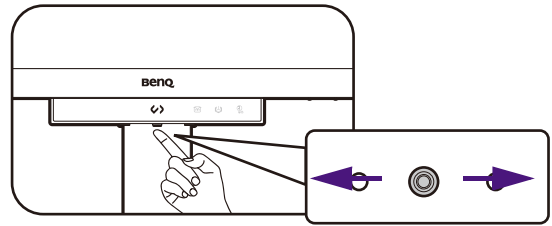
Press  /  to bring up **Quick Menu** for **MoonHalo**.



### 2. Cycle through different modes.





Press  /  to adjust the state of the function.

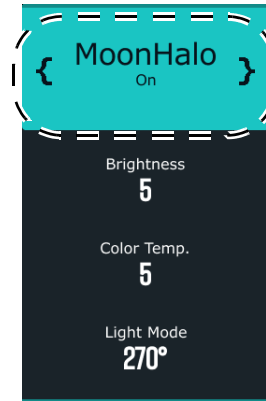

To enable **Auto Dimming**, remember to turn on **B.I. Gen2** function under **Eye Care**.



### 3. Adjust quick settings

- Press  /  to access different setting options.
- Press  /  to make adjustments.

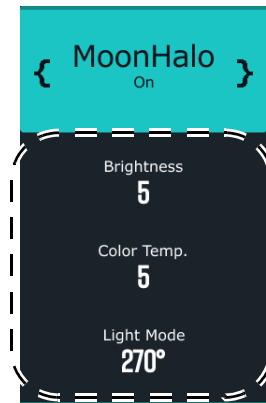

## Working with **MoonHalo** (selected models only)



For your eye safety, do not stare directly at the light

**MoonHalo** is the built-in monitor backlight that balances the lighting of your viewing environment. Activate the function to enhance working efficiency and reduce eye strain.

1. Press  to bring up the main menu.
2. Go to **Coding Booster** > **MoonHalo**.
3. Under **Switch**, choose either **Auto Dimming** or **ON**. For **Auto Dimming**, it automatically adjusts **MoonHalo**'s brightness based on ambient light detection, syncs with screen brightness and safeguards your eyes in low-light environments.





**Auto Dimming** will be grayed out if **B.I. Gen2** is not enabled. Go to **Menu** > **Eye Care** > **B.I. Gen2** and set the function to **ON**.

4. Set your **Brightness**, **Color Temperature**, **Light Mode** preferences. Those settings will be saved and applied by color mode switch.

## Using **MoonHalo** as night light (**Non-stop Mode**)

To activate **MoonHalo** when the monitor is in sleep mode, you can turn on the **Non-stop Mode**.

1. Press  to bring up the main menu.
2. Go to **Coding Booster > MoonHalo > Non-stop Mode** and choose **ON**. Once set to **ON**, **MoonHalo** will light up when the input source is inactive.
3. Press  /  as the shortcut to enable/disable **MoonHalo** when the monitor is in sleep mode.



The **MoonHalo** setting value is the last used settings before the monitor turns inactive. To adjust detail settings, access the monitor's OSD menu. The adjustment will be saved and applied by color mode switch.

## Working with **Night Hours Protection**

The **Night Hours Protection** aims to safeguard your eyes by offering a minimum brightness technology. Its intelligent ambient light detection and auto-switch capabilities ensure effortless and consistent eye care.

1. Press  to bring up the main menu.
2. Go to **Eye Care > Night Hours Protection**.
3. Under **Switch**, choose either **ON** or **Auto Switch**. For **Auto Switch**, the monitor automatically enables or disables the function depending on your ambient light.
4. Under **Level**, adjust the value of the filter. A stronger effect is produced as the value increases.
5. LED indicator on the function bar will light up when the function is turned on. You can adjust the LED behavior from **Coding Booster > Function Bar > LED Indicator**.

## Protecting your screen privacy (**EcoPrivacy**)

**EcoPrivacy** helps save power and protect screen privacy by dimming your monitor once inactivity. The built-in proximity sensor detects your presence within a default range.

1. Press  to bring up the main menu.
2. Go to **Coding Booster > Activation Time** to set a desired inactivity duration to activate EcoPrivacy.
3. Go to **Coding Booster > Sensor Sensitivity** to adjust the sensor distance between you and the screen.

## Working with **Low Blue Light Plus**



The function works with certain picture modes (color modes) only. If it is not available, its menu options will become grayed out.

The Low Blue Light Plus technology helps decrease the blue light emitted from the display to reduce the risk of blue light exposure to your eyes.

You can reduce the blue light as desired regardless of color mode.

1. Press  to bring up the main menu.
2. Go to **Eye Care > Low Blue Light Plus > ON** to enable this function.

3. LED indicator on the function bar will light up. You can adjust the LED behavior from **Coding Booster > Function Bar > LED Indicator**.

## Adjusting screen brightness automatically (**Brightness Intelligence Gen2**)



The function works with certain picture modes (color modes) only. If it is not available, its menu options will become grayed out.

The built-in light sensor works with Brightness Intelligence Gen2 technology to detect the ambient light, image brightness and contrast, and then balance the screen automatically. It helps keep image details as well as to reduce eye strain.

1. Press  to bring up the main menu.
2. Go to **Eye Care > B.I. Gen2 > ON** to enable this function.
3. LED indicator on the function bar will light up. You can adjust the LED behavior from **Coding Booster > Function Bar > LED Indicator**.



The performance of Brightness Intelligence Gen2 may be impacted by the light sources and the monitor tilt angle. If you prefer to manually adjust the brightness again as desired, go to **Menu > Eye Care > B.I. Gen2**. See [B.I. Gen2 on page 66](#) for more information.

## Enabling color vision accessibility (**Color Weakness**)



The function works with certain picture modes (color modes) only. If it is not available, its menu options will become grayed out.

**Color Weakness** is accessibility that helps people with color vision deficiency to distinguish colors. You are provided with **Red Filter** and **Green Filter** on this monitor. Choose one as needed.

1. Press  to bring up the main menu.
2. Go to **Eye Care > Color Weakness**.
3. Choose either **Red Filter** or **Green Filter**.

Adjust the value of the filter. A stronger effect is produced as the value increases.

## Resting your eyes with the help of **Eye Reminder**

The built-in proximity sensor detects your presence within the range of distance. If the sensor detects your presence for more than the set period of time, the monitor displays a pop-up message that reminds you to rest your eyes.

1. Press  to bring up the main menu.
2. Go to **Eye Care > Eye Reminder**.
3. Choose the timing for your reminder notice.

## Adjusting display mode

To display images of aspect ratios and sizes other than the native aspect ratio and display size, you can adjust the display mode on the monitor.

1. Press  to bring up the main menu.
2. Go to **System > Display Mode** or **Display > Display Mode**.
3. Select an appropriate display mode. The setting will take effect immediately.

## Choosing an appropriate color mode

Your monitor provides various color modes that are suitable for different types of images. See [Color Mode menu on page 67](#) for all the available color modes.

Go to **Color Mode** for a desired color mode.

## Available menu options to each **Color Mode**

Depending on the **Color Mode** you just set, the available options for each color adjustment may vary. The list is for reference only as available options also vary by input. Menu options that are not available will become grayed out.

Color Mode	Coding - Dark Theme	Coding - Light Theme	M-book	Cinema	Game <sup>(2)</sup>	HDR	ePaper	sRGB	User
Options									
<b>Brightness</b>	V	V	V	V	V	V <sup>(3)</sup>	V	V	V
<b>Contrast</b>	V	V	V	V	V	V <sup>(3)</sup>	V	V	V
<b>Sharpness</b>	V	V	V	V	V	V	V	V	V
<b>Saturation</b>	V	V	X	X	X	X	X	X	V
<b>Gamma</b>	X	X	X	X	X	X	X	X	V
<b>Color Temperature</b>	V	V	V	X	X	X	X	X	V
<b>B.I. Gen2</b>	V	V	V	V	V	X	V	X	V
<b>Color Weakness</b>	V	V	X	V	V	X	X	X	V
<b>Low Blue Light Plus</b>	V	V	V	V	V	X	V	X	V
<b>Night Hours Protection</b>	V	V	V	V	V	V	V	V	V
<b>MoonHalo<sup>(1)</sup></b>	V	V	V	V	V	V	V	V	V



- V: Available.
- X: Not available.
- <sup>(1)</sup> For RD280U(A) & RD320U(A) only
- <sup>(2)</sup> For RD320U(A) only
- <sup>(3)</sup> Available on RD240Q only

# Adjustable OSD settings

While some settings (e.g. OSD language) are changed and take effect immediately regardless of other monitor settings or input, most OSD settings can be adjusted and saved to go with color modes. As a color mode is selected, the desired settings are applied.

Item	Description
<b>Brightness</b>	Saved and applied by color mode switch.
<b>Contrast</b>	
<b>Sharpness</b>	
<b>Saturation</b>	
<b>Gamma</b>	
<b>Color Temperature</b>	
<b>Night Hours Protection</b>	
<b>Low Blue Light Plus</b>	
<b>B.I. Gen2</b>	
<b>Color Weakness</b>	
<b>MoonHalo*</b>	



\* For RD280U(A) & RD320U(A) only

# Connecting multiple monitors via MST (Multi-Stream Transport)



- This function is not available on Macbook series products.
- **MST** does not support connecting via HDMI cable. Menu options that are not available will become grayed out. See [The MST function does not work. on page 80](#) for more information.
- (Selected models only) If the monitor shows black screen while connecting, go to **Menu > System > USB-C Configuration** and select **USB 2.0**.

With connection via the USB-C™ or DP ports, you can output content to one or up to 4 monitors via MST function.

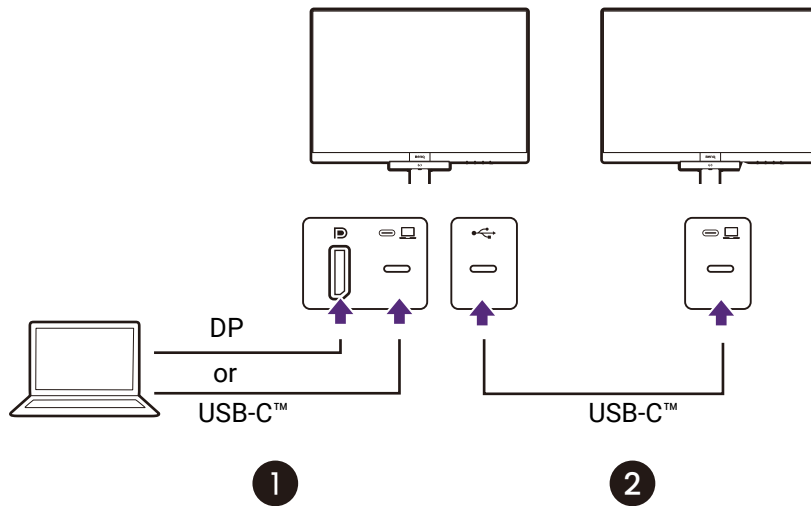

1. Connect your laptop to the USB-C™ / DP port on the monitor using a USB-C™ / DP cable. Select **YES** to enable USB-C™ power delivery in monitor standby mode if you are prompted to. The USB-C™ port supplies power to the laptop then even when the monitor is in standby mode.
2. Connect the second monitor to the first one using a USB-C™ cable.
3. Go to **Menu > Coding Booster > MST > ON**. Note the OSD menu can be launched and configured only when input signal is detected.
4. Follow Step 2 to connect the third and the fourth monitors if desired.
5. Power on the laptop and the monitors. On all the connected monitors, check the configurations as described in Step 2.
6. On you laptop, decide the way you want the content to be displayed on the connected monitors: **Duplicate**, **Extend**, or **Second screen only**. Additional software (purchased separately) may be used to manage the display. Refer to the manual of the purchased software for more information.

## Supported resolution

To perform MST, a limited number of compatible and connected monitors is required to ensure image quality. The following information shows the image resolution available to each monitor.



Make sure the graphic card on your computer supports DP 1.4 for MST. Please also be noted that the supported number of monitors for connection may vary by graphic card. To find out the compatibility of your graphic card, check its specifications or contact its manufacturer.



## RD240Q

Configuration	1 <sup>st</sup> monitor (RD240Q)	2 <sup>nd</sup> monitor (RD240Q or a compatible BenQ monitor)	3 <sup>rd</sup> monitor (RD240Q or a compatible BenQ monitor)	4 <sup>th</sup> monitor (RD240Q or a compatible BenQ monitor)
1	2560 x 1600 (60Hz)	2560 x 1600 (60Hz)	N/A	N/A
2	2560 x 1600 (60Hz)	2560 x 1600 (60Hz)	1920 x 1080 (60Hz)	N/A
3	2560 x 1600 (60Hz)	1920 x 1080 (60Hz)	1920 x 1080 (60Hz)	1920 x 1080 (60Hz)
4	1920 x 1080 (60Hz)	1920 x 1080 (60Hz)	1920 x 1080 (60Hz)	1920 x 1080 (60Hz)

## RD280U(A)

Configuration	1 <sup>st</sup> monitor (RD280U)	2 <sup>nd</sup> monitor (RD280U or a compatible BenQ monitor)	3 <sup>rd</sup> monitor (RD280U or a compatible BenQ monitor)	4 <sup>th</sup> monitor (RD280U or a compatible BenQ monitor)
1	3840 x 2560 (60Hz)	3840 x 2160 (30Hz)	N/A	N/A
2	3840 x 2160 (30Hz)	3840 x 2160 (30Hz)	1920 x 1080 (60Hz)	N/A
3	3840 x 2160 (30Hz)	1920 x 1080 (60Hz)	1920 x 1080 (60Hz)	1920 x 1080 (60Hz)
4	1920 x 1080 (60Hz)	1920 x 1080 (60Hz)	1920 x 1080 (60Hz)	1920 x 1080 (60Hz)

## RD320U(A)

Configuration	1 <sup>st</sup> monitor (RD320U)	2 <sup>nd</sup> monitor (RD320U or a compatible BenQ monitor)	3 <sup>rd</sup> monitor (RD320U or a compatible BenQ monitor)	4 <sup>th</sup> monitor (RD320U or a compatible BenQ monitor)
1	3840 x 2160 (60Hz)	3840 x 2160 (30Hz)	N/A	N/A
2	3840 x 2160 (30Hz)	3840 x 2160 (30Hz)	1920 x 1080 (60Hz)	N/A
3	3840 x 2160 (30Hz)	1920 x 1080 (60Hz)	1920 x 1080 (60Hz)	1920 x 1080 (60Hz)
4	1920 x 1080 (60Hz)	1920 x 1080 (60Hz)	1920 x 1080 (60Hz)	1920 x 1080 (60Hz)

# Sharing a set of keyboard, mouse, and other USB peripherals with KVM (selected models only)

You can shift the control devices (e.g. keyboard and mouse) and other USB peripherals among multiple video sources through KVM.

## Establishing KVM connections

RD280U(A)

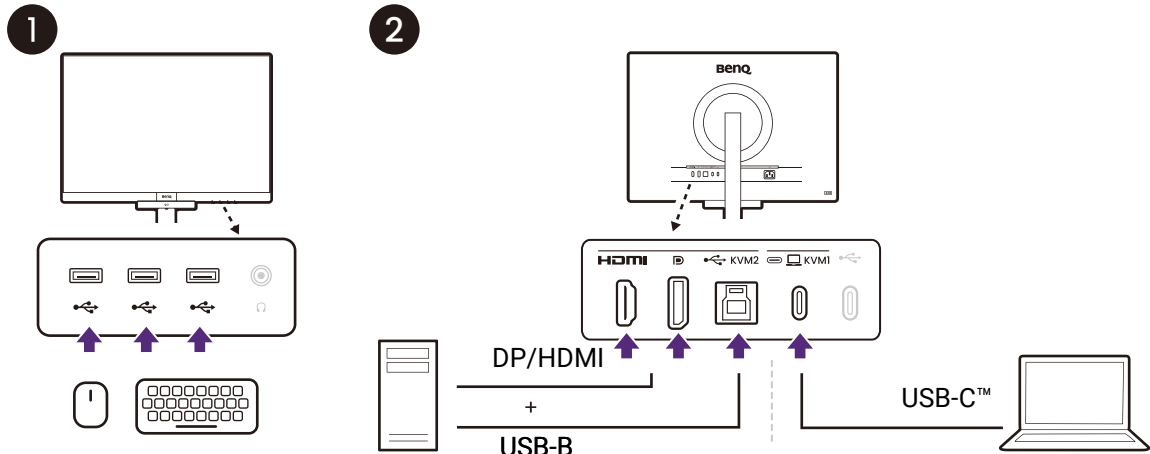

RD320U(A)

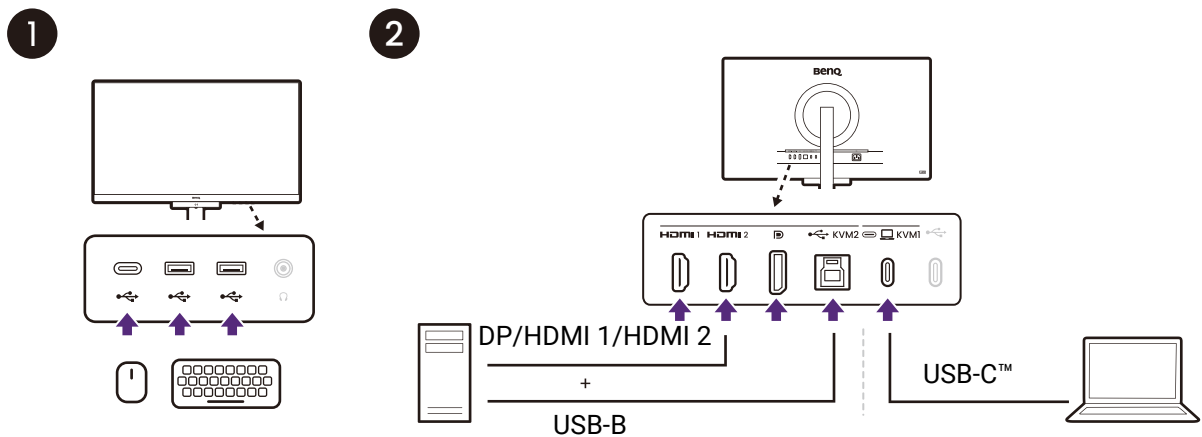

1. Connect the control devices and other USB peripherals to the USB ports on the monitor.
2. Connect at least two video sources to the monitor.
  - USB-C™ connection
  - DisplayPort/HDMI and USB-B connections
3. After the connections are made properly, the KVM function is enabled automatically. See [Switching to different video sources](#) for more information.

## Switching to different video sources

The Function Key is set to **Input** by default. Once the KVM connections have been made properly, you can press the Function Key to cycle through available KVM sources.

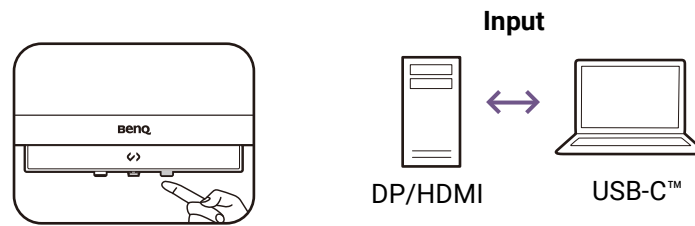

If you want the display to use only the USB Type-C (upstream) regardless of the input signal, go to **Menu > Coding Booster > KVM Switch** and select **USB-C Upstream**.

## Displaying two sources at the same time (PBP/PIP) (selected models only)

To display two input sources on the screen at the same time, you can go for Picture-in-Picture (PIP) or Picture-by-Picture (PBP) mode.



If you prefer to apply different color modes to each window in PBP/PIP mode, see [Displaying two color settings at the same time \(DualView Plus\)\(selected models only\)](#) on page 55.

## Video source selection in PBP mode

1. Press  to bring up the main menu.
2. Go to **Display > PBP**.
3. Select the preferred source for each window.
4. In **PBP > PBP Layout**, select to split the screen evenly (**1:1**) or with one bigger screen (**3:1**).
5. Under **Display**, select **SWAP** to switch the positions of two input sources.

## Video source selection in PIP mode

1. Press  to bring up the main menu.
2. Go to **Display > PIP**.
3. Select the preferred source for each window.
4. Go to **PIP Size** and **PIP Position** to select the preferred size/position of the sub window.
5. Under **Display**, select **SWAP** to switch the positions of two input sources.

## Displaying two color settings at the same time (DualView Plus)(selected models only)

**DualView Plus** helps improve your working efficiency by showing two different color modes on the same screen. This function is available for both single or dual input sources.

1. Press  to bring up the main menu.
2. Select one color mode from the **Color Mode** menu.
3. Go to **Coding Booster > DualView Plus**. Select another color mode for the second view.

After exiting the main menu, the selected color mode for each window will be shown on screen briefly.





When **DualView Plus** is activated, all settings are based on the main input source.

## Charging the connected device via USB-C™ port

The USB-C™ port on the rear of your monitor supports power delivery in standby mode yet it is disabled by default. If video source via USB-C™ port is detected, you will be prompted to enable USB-C™ power delivery function in monitor standby mode. Select **YES** to proceed.

If **Power Awake** from **System** has been turned to **ON**, the power delivery will start without further notification.

The maximum power delivery of each USB-C™ port varies. To charge a device properly, check its charging specification first and make sure an appropriate USB-C™ port is connected.

Icon	Power delivery
	90W
	7.5W

## Working with a Mac series product

You can connect your monitor to a Mac series product. Note the compatibility is up to the performance and specifications of the Mac chip on your Mac product and may be updated without prior notice.

- When connecting your monitor to a Mac product, direct connection via Thunderbolt 3 or USB-C™ cable (if available on both Mac and the monitor) is recommended to ensure good image quality. See [Connect the PC video cable on page 27](#) for details.
- To reduce the color difference, you are recommended to set the picture mode (color mode) of your monitor to **M-book**, **Display P3**, or **DCI-P3** mode (if available). See [Color Mode menu on page 67](#) for details.
- If your monitor supports certain BenQ software, check the software webpage from [www.BenQ.com](http://www.BenQ.com) to see if they work on your Mac product.

If you have any inquiries about the compatibilities with Mac products, visit [Support.BenQ.com](http://Support.BenQ.com) and look for related topics from **FAQ** or **Knowledge**.

# Navigating the main menu

You can use the OSD (On Screen Display) menu to adjust all the settings on your monitor.

Press  to bring up the main menu. See [5-way controller and basic menu operations on page 44](#) for details.

Available menu options may vary depending on the input sources, functions and settings. Menu options that are not available will become grayed out. And keys that are not available will be disabled and the corresponding OSD icons will disappear. For models without certain functions, their settings and related items will not appear on the menu.



The OSD menu languages may differ from the product supplied to your region, see [Language on page 74](#) under **System** and **OSD Settings** for more details.

---

For more information on each menu, please refer to the following pages:

- [Input menu \(selected models only\) on page 58](#)
- [Display menu \(selected models only\) on page 59](#)
- [Coding Booster menu on page 62](#)
- [Eye Care menu on page 65](#)
- [Color Mode menu on page 67](#)
- [Audio menu on page 70](#)
- [Custom menu on page 71](#)
- [System menu on page 73](#)

## Input menu (selected models only)

Available menu options may vary depending on the input sources, functions and settings. Menu options that are not available will become grayed out. And keys that are not available will be disabled and the corresponding OSD icons will disappear. For models without certain functions, their settings and related items will not appear on the menu.

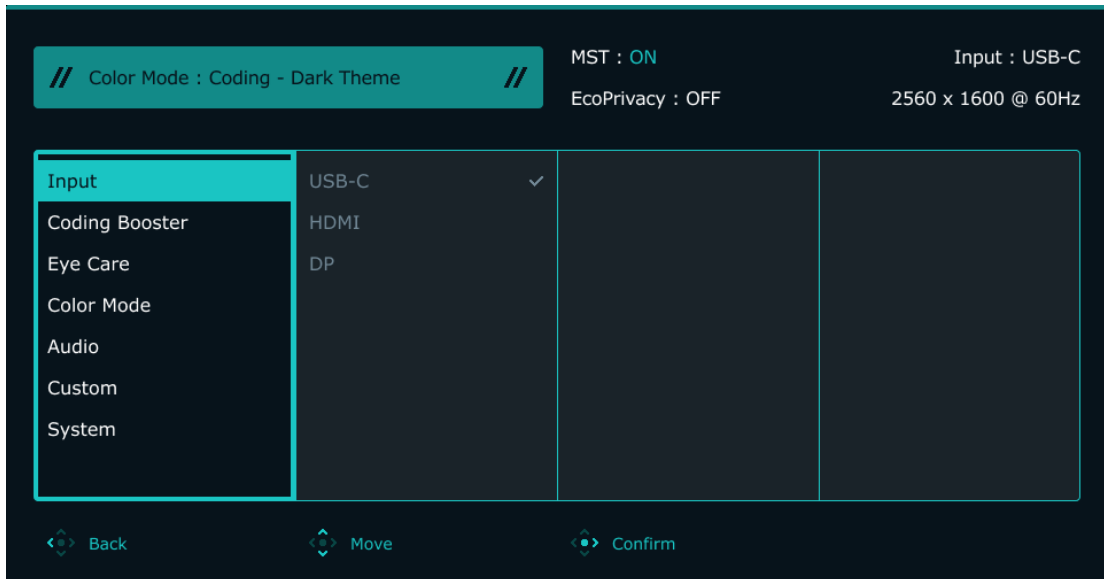

1. Press to bring up the main menu.
2. Use or to select **Input**.
3. Select to go to a sub menu, and then use or to select a menu item.
4. Use or to make adjustment, or use to make selection.
5. To return to the previous menu, select .
6. To exit the menu, select .

Item	Function	Range
<b>Input</b>	Use this to change the input to that appropriate to your video cable connection type.	<ul style="list-style-type: none"> <li>• <b>USB-C</b></li> <li>• <b>HDMI</b></li> <li>• <b>DP</b></li> </ul>

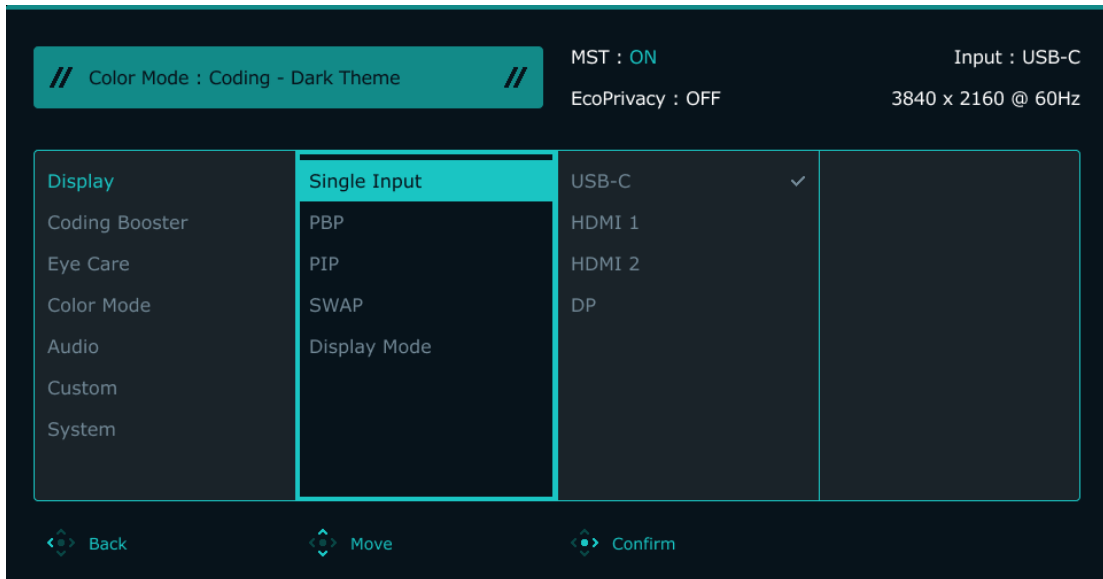

## Display menu (selected models only)

Available menu options may vary depending on the input sources, functions and settings. Menu options that are not available will become grayed out. And keys that are not available will be disabled and the corresponding OSD icons will disappear. For models without certain functions, their settings and related items will not appear on the menu.



1. Press to bring up the main menu.
2. Use or to select **Display**.
3. Select to go to a sub menu, and then use or to select a menu item.
4. Use or to make adjustment, or use to make selection.
5. To return to the previous menu, select .
6. To exit the menu, select .

Item	Function	Range
<b>Signal Input</b>	Use this to change the input to that appropriate to your video cable connection type.	<ul style="list-style-type: none"> <li>• <b>USB-C</b></li> <li>• <b>HDMI 1</b></li> <li>• <b>HDMI 2</b></li> <li>• <b>DP</b></li> </ul>

Item	Function	Range	
<b>PBP</b>	Sets the PBP mode to have two pictures displayed side-by-side. Determines the video sources for the left and the right windows respectively.  Not recommended when HDR function is enabled.	<ul style="list-style-type: none"> <li>• <b>Left</b></li> <li>• <b>Right</b></li> </ul>	
	<b>Left</b>	Decides the input displayed on the left.	<ul style="list-style-type: none"> <li>• <b>USB-C</b></li> <li>• <b>HDMI 1</b></li> <li>• <b>HDMI 2</b></li> <li>• <b>DP</b></li> </ul>
	<b>Right</b>	Decides the input displayed on the right.	
	<b>PBP Layout</b>	Decides the proportion of two screens.	<ul style="list-style-type: none"> <li>• <b>1:1</b></li> <li>• <b>3:1</b></li> </ul>
<b>PIP</b>	Sets the PIP mode. Pictures from two independent video sources are displayed on the screen at the same time.  The audio input is from the main source if the PIP mode is activated.  Not recommended when HDR function is enabled.		
	<b>Main</b>	Decides the main video source.	<ul style="list-style-type: none"> <li>• <b>USB-C</b></li> <li>• <b>HDMI 1</b></li> <li>• <b>HDMI 2</b></li> <li>• <b>DP</b></li> </ul>
	<b>Sub</b>	Decides the second video source for PIP mode.	
	<b>PIP Size</b>	Decides the size of the inset window in the PIP mode.	<ul style="list-style-type: none"> <li>• <b>Small</b></li> <li>• <b>Medium</b></li> <li>• <b>Large</b></li> </ul>
	<b>PIP Position</b>	Adjusts the position of the inset window in the PIP mode.	<ul style="list-style-type: none"> <li>• <b>Top Right</b></li> <li>• <b>Top Left</b></li> <li>• <b>Bottom Right</b></li> <li>• <b>Bottom Left</b></li> </ul>
<b>SWAP</b>	Videos from the main and the second sources are swapped on the screen.		



Item	Function	Range
<b>Display Mode</b>	<p>This feature is provided to allow aspect ratios other than the native aspect ratio to be displayed without geometric distortion.</p>  <p>The options under <b>Display Mode</b> will be different depending on the input signal sources.</p>	
	<p><b>Full</b></p> <p>Scales the input image to fill the screen. Ideal for images that fits the native aspect ratio.</p>	
	<p><b>Aspect</b></p> <p>The input image is displayed without geometric distortion filling as much of the display as possible.</p>	

## Coding Booster menu

Available menu options may vary depending on the input sources, functions and settings. Menu options that are not available will become grayed out. And keys that are not available will be disabled and the corresponding OSD icons will disappear. For models without certain functions, their settings and related items will not appear on the menu.

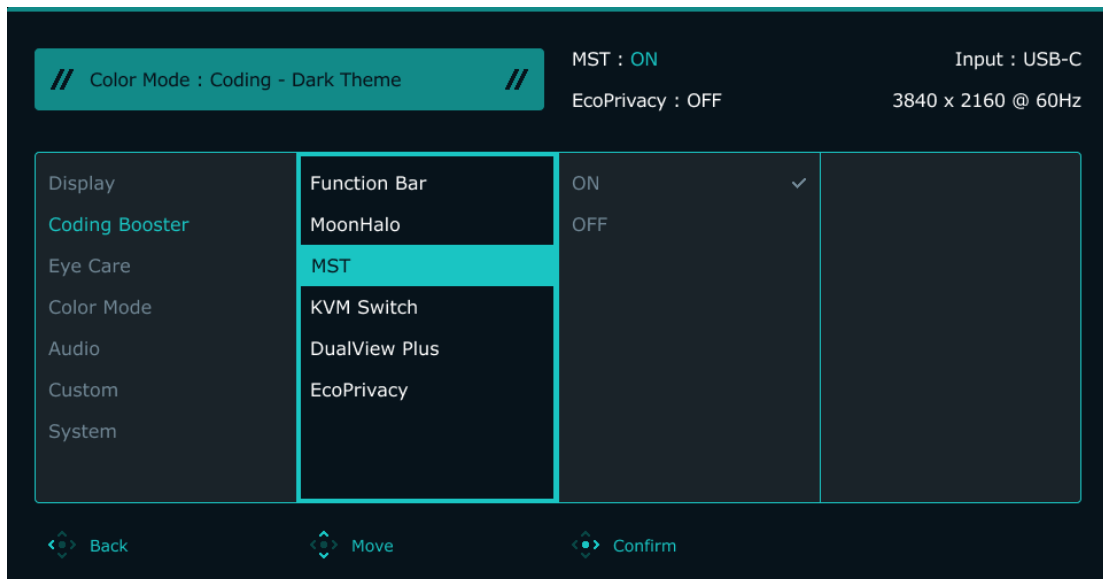

1. Press to bring up the main menu.
2. Use or to select **Coding Booster**.
3. Select to go to a sub menu, and then use or to select a menu item.
4. Use or to make adjustment, or use to make selection.
5. To return to the previous menu, select .
6. To exit the menu, select .

Item	Function	Range
<b>Function Bar</b>	Adjusts the LED indicator on the function bar.	
	<b>Power Key LED</b>	<ul style="list-style-type: none"> <li>• ON</li> <li>• OFF</li> </ul>
	<b>LED Indicator</b>  LED indicators are for <a href="#">Night Hours Protection</a> , <a href="#">Low Blue Light Plus</a> , and <a href="#">B.I. Gen2</a> . The LED indicators lights up when the function is turned on.	<ul style="list-style-type: none"> <li>• 10 sec.</li> <li>• ON</li> <li>• OFF</li> </ul>









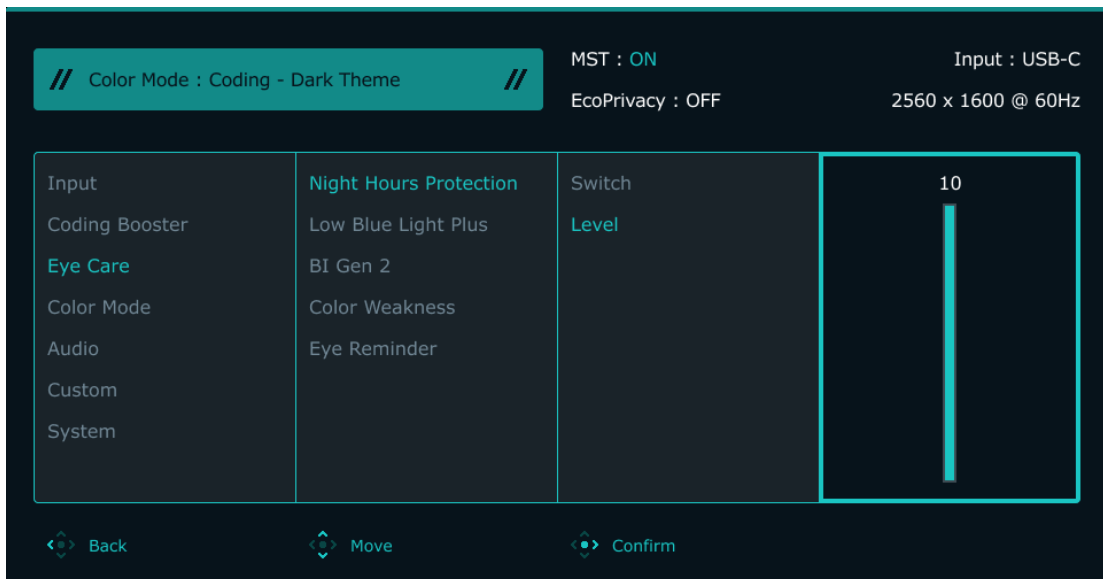

Item	Function	Range
<b>MoonHalo</b> (selected models only)	This function activates built-in monitor backlight that balances the lighting of your viewing environment. See <a href="#">Working with MoonHalo (selected models only) on page 47</a> for more information.	
	<b>Switch</b>	<ul style="list-style-type: none"> <li>• <b>Auto Dimming</b></li> <li>• <b>ON</b></li> <li>• <b>OFF</b></li> </ul>
	<b>Brightness</b>	<ul style="list-style-type: none"> <li>• 1 ~ 10</li> </ul>
	<b>Color Temperature</b>	<ul style="list-style-type: none"> <li>• 1 ~ 7</li> </ul>
	<b>Light Mode</b>	<ul style="list-style-type: none"> <li>• <b>360°</b></li> <li>• <b>270°</b></li> </ul>
	<b>Non-Stop Mode</b>	<ul style="list-style-type: none"> <li>• <b>ON</b></li> <li>• <b>OFF</b></li> </ul>
<b>MST</b>	Allows data transmission while multiple monitors are daisy-chained. See <a href="#">Connecting multiple monitors via MST (Multi-Stream Transport) on page 52</a> for more information.   Available only when the input source is DP or USB-C™. Not available on Macbook series products.	<ul style="list-style-type: none"> <li>• <b>ON</b></li> <li>• <b>OFF</b></li> </ul>
<b>KVM Switch</b> (selected models only)	Switches the keyboard and mouse control over different inputs. See <a href="#">Sharing a set of keyboard, mouse, and other USB peripherals with KVM (selected models only) on page 54</a> for more information.	
	<b>Auto</b>	The USB ports are switched automatically when the input signals switch.
	<b>USB-C Upstream</b>	Enables USB Type-C (upstream) regardless of the input signal.

Item	Function	Range
<b>DualView Plus</b> (selected models only)	<p>Selects the color mode of the sub window.</p> <p>Once enabled, the main window shows the mode selected from <b>Color Mode</b>, while the sub window presents the mode specified here.</p> <p> When <b>DualView Plus</b> is activated, all settings are based on the main input source.</p>	<ul style="list-style-type: none"> <li>• <b>Coding - Dark Theme</b></li> <li>• <b>Coding - Light Theme</b></li> <li>• <b>M-book</b></li> <li>• <b>Cinema</b></li> <li>• <b>Game</b></li> <li>• <b>HDR</b></li> <li>• <b>ePaper</b></li> <li>• <b>sRGB</b></li> <li>• <b>User</b></li> <li>• <b>OFF</b></li> </ul>
<b>EcoPrivacy</b>	<p>This function saves power and protects screen privacy by dimming the monitor once inactivity. The built-in proximity sensor detects your presence within a default range.</p> <p>See <a href="#">Protecting your screen privacy (EcoPrivacy) on page 48</a> for more information.</p>	
	<b>Activation Time</b>	<ul style="list-style-type: none"> <li>• <b>5 sec.</b></li> <li>• <b>10 sec.</b></li> <li>• <b>20 sec.</b></li> <li>• <b>30 sec.</b></li> <li>• <b>60 sec.</b></li> <li>• <b>OFF</b></li> </ul>
	<b>Sensor Sensitivity</b>	<ul style="list-style-type: none"> <li>• <b>Near</b></li> <li>• <b>Middle</b></li> <li>• <b>Far</b></li> </ul>

## Eye Care menu

Available menu options may vary depending on the input sources, functions and settings. Menu options that are not available will become grayed out. And keys that are not available will be disabled and the corresponding OSD icons will disappear. For models without certain functions, their settings and related items will not appear on the menu.



1. Press  to bring up the main menu.
2. Use  or  to select **Eye Care**.
3. Select  to go to a sub menu, and then use  or  to select a menu item.
4. Use  or  to make adjustment, or use  to make selection.
5. To return to the previous menu, select .
6. To exit the menu, select .

Item	Function	Range
<b>Night Hours Protection</b>	Minimize screen brightness to protect your eyes under extremely dark environment. See <a href="#">Working with Night Hours Protection on page 48</a> for more information.	
	<b>Switch</b> If your environment is too dark, the monitor displays a pop-up message that asks you to turn on the function.	<ul style="list-style-type: none"> <li>• <b>Auto Switch</b></li> <li>• <b>ON</b></li> <li>• <b>OFF</b></li> </ul>
	<b>Level</b> A stronger effect is produced as the value increases.	1 ~ 10
<b>Low Blue Light Plus</b>	Decreases the blue light emitted from the display to reduce the risk of blue light exposure to your eyes. See <a href="#">Working with Low Blue Light Plus on page 48</a> for more information.	0 ~ 5

Item	Function		Range
<b>B.I. Gen2</b>	Turns the Brightness Intelligence Gen2 function on or off. The built-in light sensor works with Bright Intelligence technology to detect the ambient light, image brightness and contrast, and then balance the screen automatically. See <a href="#">Adjusting screen brightness automatically (Brightness Intelligence Gen2)</a> on page 49 for more information.		<ul style="list-style-type: none"> <li>• <b>ON</b></li> <li>• <b>OFF</b></li> </ul>
	<b>Light Meter</b>	Sets to display the light condition around the monitor on the screen.	<ul style="list-style-type: none"> <li>• <b>ON</b></li> <li>• <b>OFF</b></li> </ul>
	<b>Sensor Sensitivity</b>	Adjusts the senseitivity of the built-in sensor.	0 ~ 10
<b>Color Weakness</b>	Adjusts color matching representation for people with color vision deficiency to distinguish colors easily.		
	<b>Red Filter</b>	Decides the effect produced by the red filter. A stronger effect is produced as the value increases.	0 ~ 10
	<b>Green Filter</b>	Decides the effect produced by the green filter. A stronger effect is produced as the value increases.	0 ~ 10
<b>Eye Reminder</b>	Allows the built-in proximity sensor to detect your presence within the range of distance. If the sensor detects your presence for more than the set period of time, the monitor displays a pop-up message that reminds you to rest your eyes.		<ul style="list-style-type: none"> <li>• <b>OFF</b></li> <li>• <b>30 min</b></li> <li>• <b>45 min</b></li> <li>• <b>60 min</b></li> </ul>

## Color Mode menu

Available menu options may vary depending on the input sources, functions and settings. Menu options that are not available will become grayed out. And keys that are not available will be disabled and the corresponding OSD icons will disappear. For models without certain functions, their settings and related items will not appear on the menu.

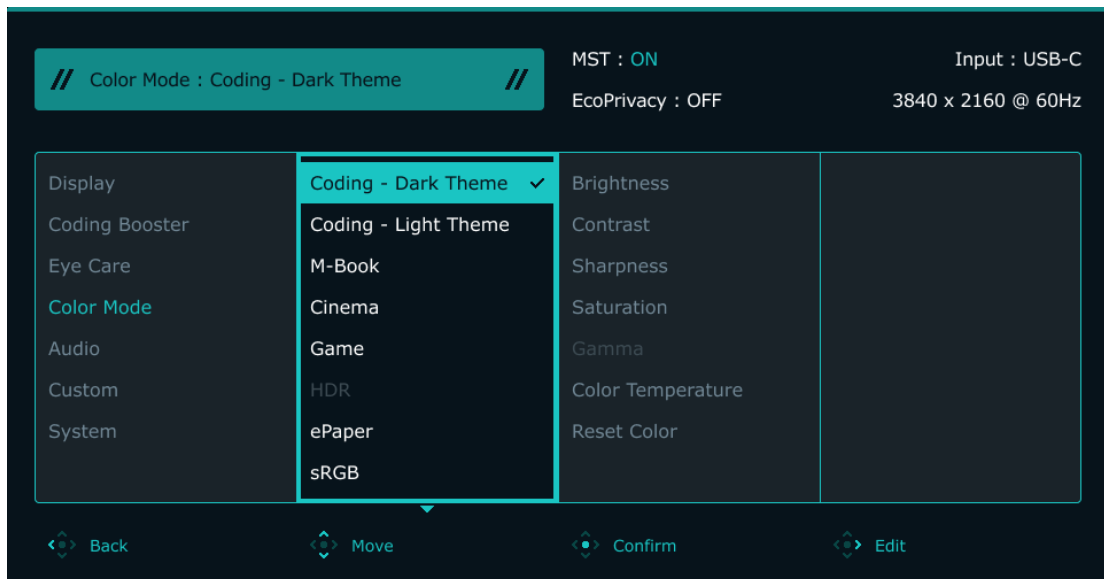

1. Press to bring up the main menu.
2. Use or to select **Color Mode**.
3. Select to go to a sub menu, and then use or to select a menu item.
4. Use or to make adjustment, or use to make selection.
5. To return to the previous menu, select .
6. To exit the menu, select .

Item	Function
<b>Coding - Dark Theme</b>	For coding environment (IDE) in dark theme.
<b>Coding - Light Theme</b>	For coding environment (IDE) in light theme.
<b>M-book</b>	Minimizes the visual differences between the monitor and the connected MacBook series product.
<b>Cinema</b>	For viewing videos. Enhances contrast and saturation for better image clarity and color enrichment.
<b>Game</b> (selected models only)	For playing video games.
<b>HDR</b>	For better color matching representation with High Dynamic Range (HDR) technology.
<b>ePaper</b>	For reading e-books or documents in black and white with suitable on-screen brightness and clear texts.

Item	Function
<b>sRGB</b>	For better color matching representation with the peripheral devices, such as printers, digital cameras, etc.
<b>User</b>	Applies a combination of picture settings defined by users.

## Customizing each **Color Mode**

For different color modes, you can further adjust the color settings for detailed color adjustment. The available options for each color mode may vary.

Item	Function	Range
<b>Brightness / Brightness(B.I.On)</b>	Adjusts the balance between light and dark shades. <b>Brightness(B.I.On)</b> is available when B.I. Gen2 function is enabled. See <a href="#">Adjusting screen brightness automatically (Brightness Intelligence Gen2) on page 49</a> for more information.	0 to 100
<b>Contrast</b>	Adjusts the degree of difference between darkness and lightness.	0 to 100
<b>Sharpness</b>	Adjusts the clarity and visibility of the edges of the subjects in the image.	1 to 10
<b>Saturation</b>	Adjusts the purity degree of colors.	0 to 10
<b>Gamma</b>	Adjusts the tone luminance. The default value is <b>3</b> (the standard value for Windows).	<ul style="list-style-type: none"> <li>• <b>1</b></li> <li>• <b>2</b></li> <li>• <b>3</b></li> <li>• <b>4</b></li> <li>• <b>5</b></li> </ul>
<b>Color Temperature</b>	<b>Normal</b>	Allows video and still photographs to be viewed with natural coloring. This is the factory default color.
	<b>Bluish</b>	Applies a cool tint to the image and is factory pre-set to the PC industry standard white color.
	<b>Reddish</b>	Applies a warm tint to the image and is factory pre-set to the news print standard white color.
	<b>User Define</b>	<p>The blend of the Red, Green and Blue primary colors can be altered to change the color tint of the image. Go to the succeeding <b>R</b> (red), <b>G</b> (green), and <b>B</b> (blue) menus to change the settings.</p> <p>Decreasing one or more of the colors will reduce their respective influence on the color tint of the image. (e.g. if you reduce the Blue level the image will gradually take on a yellowish tint. If you reduce Green, the image will become a magenta tint.)</p>
		<ul style="list-style-type: none"> <li>• <b>R</b> (0~100)</li> <li>• <b>G</b> (0~100)</li> <li>• <b>B</b> (0~100)</li> </ul>



Item	Function	Range
<b>Reset Color</b>	Resets the custom color settings to the factory defaults.	• <b>YES</b> • <b>NO</b>

## Audio menu

Available menu options may vary depending on the input sources, functions and settings. Menu options that are not available will become grayed out. And keys that are not available will be disabled and the corresponding OSD icons will disappear. For models without certain functions, their settings and related items will not appear on the menu.

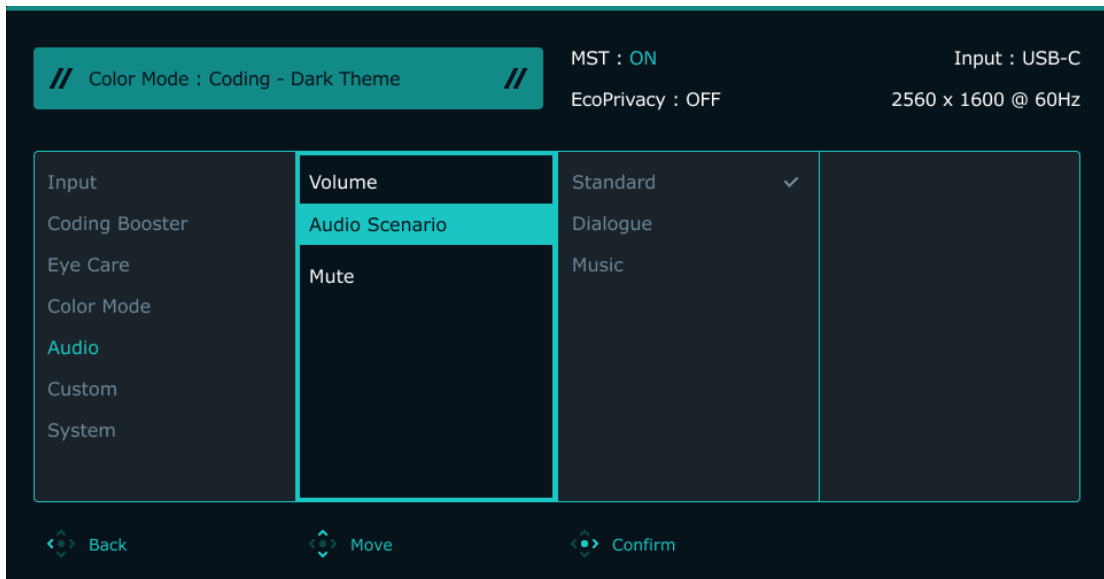

1. Press to bring up the main menu.
2. Use or to select **Audio**.
3. Select to go to a sub menu, and then use or to select a menu item.
4. Use or to make adjustment, or use to make selection.
5. To return to the previous menu, select .
6. To exit the menu, select .

Item	Function	Range
<b>Volume</b>	Adjusts the audio volume.	0 ~ 50
<b>Audio Scenario</b>	Selects one of the equalizers to obtain the best audio effect in certain scenarios.	
	<b>Standard</b>	Balances all settings for use without a specific scenario.
	<b>Dialogue</b>	Cancels noise to improve sound clarity.
	<b>Music</b>	Keeps the music and the vocal in harmony as if in live.
<b>Mute</b>	Turns the volume on or off.	<ul style="list-style-type: none"> <li>• ON</li> <li>• OFF</li> </ul>

## Custom menu

Available menu options may vary depending on the input sources, functions and settings. Menu options that are not available will become grayed out. And keys that are not available will be disabled and the corresponding OSD icons will disappear. For models without certain functions, their settings and related items will not appear on the menu.

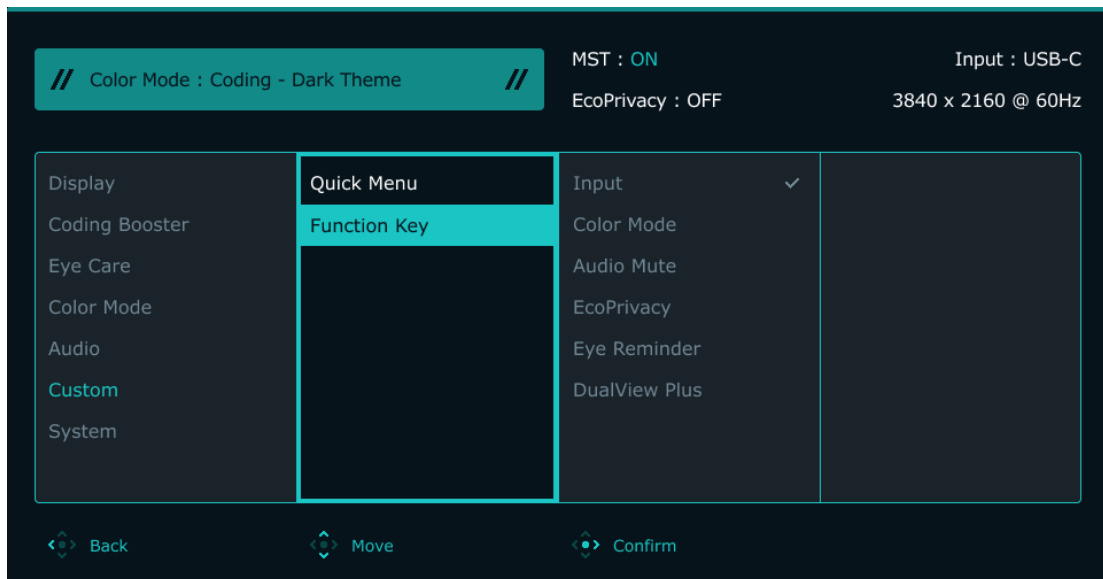

1. Press to bring up the main menu.
2. Use or to select **Custom**.
3. Select to go to a sub menu, and then use or to select a menu item.
4. Use or to make adjustments, or use to make selection.
5. To return to the previous menu, select . To exit the menu, press the Exit key.

Item	Function	Range
<b>Quick Menu</b>	Sets the function to be accessed by Quick Menu. Choose 2 to 4 options to be accessed by this key.	<ul style="list-style-type: none"> <li>• <b>Brightness</b></li> <li>• <b>Contrast</b></li> <li>• <b>Sharpness</b></li> <li>• <b>Low Blue Light Plus</b></li> <li>• <b>Night Hours Protection</b></li> </ul>

Item	Function	Range
<b>Function Key</b>	Sets the function to be accessed by Function key.	<ul style="list-style-type: none"> <li>• <b>Input</b></li> <li>• <b>Color Mode</b></li> <li>• <b>Audio Mute</b></li> <li>• <b>EcoPrivacy</b></li> <li>• <b>Eye Reminder</b></li> <li>• <b>DualView Plus</b> (selected models only)</li> </ul>

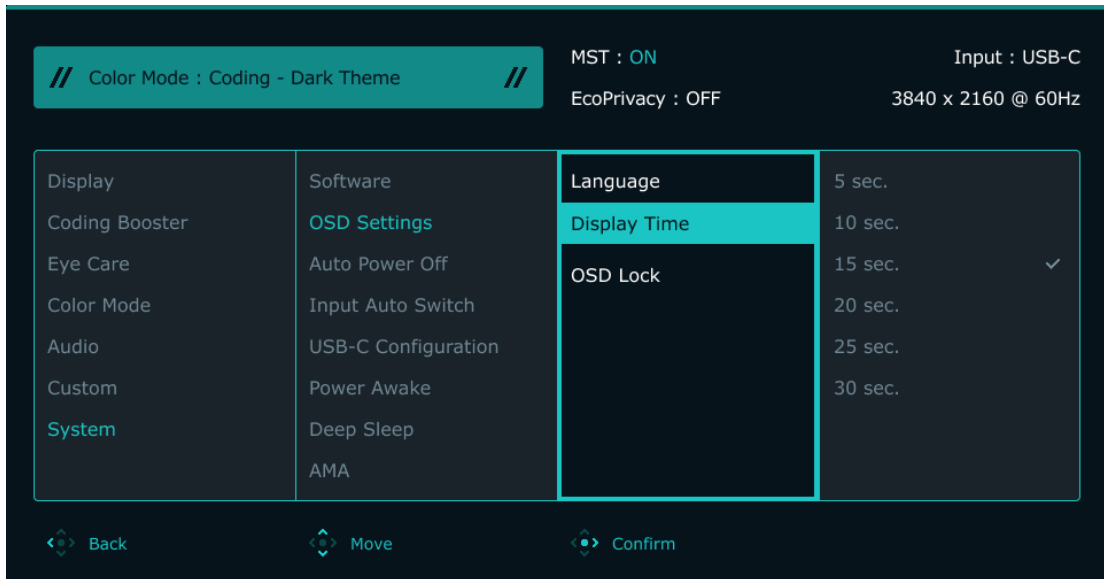

# System menu

Available menu options may vary depending on the input sources, functions and settings. Menu options that are not available will become grayed out. And keys that are not available will be disabled and the corresponding OSD icons will disappear. For models without certain functions, their settings and related items will not appear on the menu.





1. Press to bring up the main menu.
2. Use or to select **System**.
3. Select to go to a sub menu, and then use or to select a menu item.
4. Use or to make adjustment, or use to make selection.
5. To return to the previous menu, select .
6. To exit the menu, select .

Item	Function	Range
<b>Software</b>	Displays the QR code of <b>Display Pilot 2</b> . Scan for quick access to the software download page.	

Item	Function		Range
<b>OSD Settings</b>	<b>Language</b>	Sets the OSD menu language.   The language options displayed on your OSD may differ from those shown on the right, depending on the product supplied in your region.	<ul style="list-style-type: none"> <li>• English</li> <li>• Français</li> <li>• Deutsch</li> <li>• Italiano</li> <li>• Español</li> <li>• Polski</li> <li>• Český</li> <li>• Magyar</li> <li>• Română</li> <li>• Nederlands</li> <li>• Русский</li> <li>• Svenska</li> <li>• Português</li> <li>• 日本語</li> <li>• 繁體中文</li> <li>• 简体中文</li> <li>• العربية</li> <li>• 한국어</li> </ul>
	<b>Display Time</b>	Adjusts the display time of the OSD menu.	<ul style="list-style-type: none"> <li>• 5 sec.</li> <li>• 10 sec.</li> <li>• 15 sec.</li> <li>• 20 sec.</li> <li>• 25 sec.</li> <li>• 30 sec.</li> </ul>
	<b>OSD Lock</b>	Prevents all the monitor settings from being accidentally changed. When this function is activated, the OSD controls and hotkey operations will be disabled.   To unlock the OSD controls, press and hold any key for 5 seconds.	
<b>Auto Power Off</b>	Sets the time to power off the monitor automatically in power saving mode.		<ul style="list-style-type: none"> <li>• 10 min</li> <li>• 20 min</li> <li>• 30 min</li> <li>• OFF</li> </ul>
<b>Input Auto Scan</b>	Sets to automatically detect the available input source.		<ul style="list-style-type: none"> <li>• ON</li> <li>• OFF</li> </ul>

Item	Function	Range
<b>USB-C Configuration</b> (models with USB-C™)	Sets the refresh rate of the input video via USB-C™ port. The USB transmission speed changes accordingly due to USB-C™ technology limitation.	
	<b>USB 3.2</b>	Refresh rate: 3840 x 2560 @ 60Hz USB transmission speed: 5 Gbps
	<b>USB 2.0</b>	Refresh rate: 3840 x 2560 @ 60Hz USB transmission speed: 480 Mbps
<b>Power Awake</b> (models with USB-C™)	If this function is disabled, the USB-C™ port is not supplied with power while the monitor is in standby mode.  To keep supplying power to the USB-C™ port in monitor's standby mode, change the setting to <b>ON</b> .	<ul style="list-style-type: none"> <li>• <b>ON</b></li> <li>• <b>OFF</b></li> </ul>
<b>Deep Sleep</b>	Sets to enable/disable deep sleep (power-saving) mode. <ul style="list-style-type: none"> <li>• If enabled, the monitor enters deep sleep mode when the power button is pressed, consuming less power.</li> <li>• If disabled, the monitor turns off the backlight without entering deep sleep mode when the power button is pressed. This allows the monitor to wake up more quickly and recover from sleep mode in a shorter time.</li> </ul>	<ul style="list-style-type: none"> <li>• <b>ON</b></li> <li>• <b>OFF</b></li> </ul>
<b>AMA</b>	Improves the gray level response time of the LCD panel.	<ul style="list-style-type: none"> <li>• <b>Premium</b></li> <li>• <b>High</b></li> <li>• <b>OFF</b></li> </ul>
<b>Backlight Control</b>	(Available only when the input is HDR-compatible.) Once enabled, the monitor may flicker when playing HDR content as the backlight changes dynamically with the content. This is a normal phenomenon. You can disable this function as desired.	<ul style="list-style-type: none"> <li>• <b>ON</b></li> <li>• <b>OFF</b></li> </ul>
<b>DDC/CI</b>	Allows the monitor settings to be set through the software on the PC.   DDC/CI, short for Display Data Channel/Command Interface, which was developed by Video Electronics Standards Association (VESA). DDC/CI capability allows monitor controls to be sent via the software for remote diagnostics.	<ul style="list-style-type: none"> <li>• <b>ON</b></li> <li>• <b>OFF</b></li> </ul>











Item	Function	Range	
<b>Display Mode</b> (selected models only)	This feature is provided to allow aspect ratios other than the native aspect ratio to be displayed without geometric distortion.   The options under <b>Display Mode</b> will be different depending on the input signal sources.		
	<b>Full</b>	Scales the input image to fill the screen. Ideal for images that fits the native aspect ratio.	
	<b>Aspect</b>	The input image is displayed without geometric distortion filling as much of the display as possible.	
<b>Overscan</b>	Slightly enlarges the input image. Use this feature to hide annoying edge noise if present around your image.   Available only when the input source is HDMI.	<ul style="list-style-type: none"> <li>• <b>ON</b></li> <li>• <b>OFF</b></li> </ul>	
<b>RGB PC Range</b>	Determines the range of color scales. Select an option that matches the RGB range setting on the connected HDMI device.	<ul style="list-style-type: none"> <li>• <b>Auto Detect</b></li> <li>• <b>RGB (0~255)</b></li> <li>• <b>RGB (16~235)</b></li> </ul>	
<b>Resolution Notice</b>	Sets whether to display the resolution notice of the recommended resolution when a new input source is detected by the monitor.	<ul style="list-style-type: none"> <li>• <b>ON</b></li> <li>• <b>OFF</b></li> </ul>	
<b>Information</b>	Displays the current monitor property settings.	<ul style="list-style-type: none"> <li>• <b>Current Resolution</b></li> <li>• <b>Optimum Resolution</b> (best with the monitor)</li> <li>• <b>HDR</b></li> <li>• <b>Model Name</b></li> </ul>	
<b>Reset All</b>	Resets all mode, color and geometry settings to the factory default values.	<ul style="list-style-type: none"> <li>• <b>YES</b></li> <li>• <b>NO</b></li> </ul>	









# Troubleshooting





## Frequently asked questions (FAQ)

### Imaging



-  The image is blurred.
-  • Download **Resolution** file from the website (see [Product support on page 4](#)). Refer to "**Adjusting the Screen Resolution**". And then select the correct resolution, refresh rate and make adjustments based on these instructions.
- If a VGA extension cable is used, remove the extension cable for the test. Is the image now in focus? Download **Resolution** file from the website (see [Product support on page 4](#)). Refer to "**Adjusting the Screen Resolution**". And then select the correct resolution, refresh rate and make adjustments based on these instructions to optimize the image. It is normal for blurring to occur due to conduction losses in extension cables. You can minimize these losses by using an extension cable with better conduction quality or with a built-in booster.
-  Does the blurring only occur at resolutions lower than the native (maximum) resolution?
-  Download **Resolution** file from the website (see [Product support on page 4](#)). Refer to "**Adjusting the Screen Resolution**". Select the native resolution.
-  Pixel errors can be seen.
- One of several pixels is permanently black, one or more pixels are permanently white, one or more pixels are permanently red, green, blue or another color.
-  • Clean the LCD screen.
- Cycle power on-off.
- These are pixels that are permanently on or off and is a natural defect that occurs in LCD technology.
-  The image has a faulty coloration.
-  It has a yellow, blue or pink appearance.
- Go to **Color** and **Reset Color**, and then choose **YES** to reset the color settings to the factory defaults.
- If the image is still not correct and the OSD also has faulty coloration, this means one of the three primary colors is missing in the signal input. Now check the signal cable connectors. If any pin is bent or broken off, please contact your dealer to get necessary support.
-  The image is distorted, flashes or flickers.
-  Download **Resolution** file from the website (see [Product support on page 4](#)). Refer to "**Adjusting the Screen Resolution**". And then select the correct resolution, refresh rate and make adjustments based on these instructions.

-  You are running the monitor at its native resolution, but the image is still distorted.
-  Images from different input sources may appear distorted or stretched on the monitor running at its native resolution. To have the optimal display performance of each type of input sources, you can use the **Display Mode** function to set a proper aspect ratio for the input sources. See [Display Mode on page 76](#) for details.
-  The image is displaced in one direction.
-  Download **Resolution** file from the website (see [Product support on page 4](#)). Refer to "**Adjusting the Screen Resolution**". And then select the correct resolution, refresh rate and make adjustments based on these instructions.
-  Faint shadow from the static image displayed is visible on the screen.
- 
  - Activate the power management function to let your computer and monitor go into a low power "sleep" mode when not actively in use.
  - Use a screensaver to prevent the occurrence of image retention.

## LED indicator

-  The power LED indicator is white or orange.
- 
  - If the LED lights up in solid white, the monitor is powered on.
  - If the LED is illuminated in white and there is a message **Out of Range** on the screen, this means you are using a display mode that this monitor does not support, please change the setting to one of the supported mode. Download **Resolution** file from the website (see [Product support on page 4](#)). Refer to "**Adjusting the Screen Resolution**". And then select the correct resolution, refresh rate and make adjustments based on these instructions.
  - If the LED is illuminated in orange, the power management mode is active. Press any button on the computer keyboard or move the mouse. If that does not help, check the signal cable connectors. If any pin is bent or broken off, please contact your dealer to get necessary support.
  - If the LED is off, check the power supply mains socket, the external power supply and the mains switch.
-  The LED indicator on Function Bar is not lighting up.
- 
  - Check whether the LED indicator is set to **10 sec.** or **ON**. See [LED Indicator on page 62](#) for more information.
  - Check whether all accessible functions are activated, see [Night Hours Protection on page 65](#), [Low Blue Light Plus on page 65](#), and [B.I. Gen2 on page 66](#). for more information.

## OSD controls

-  The OSD controls are inaccessible.
-  To unlock the OSD controls when it is preset to be locked, press and hold any key for 5 seconds.

## OSD messages

- ? A message **Out of Range** on the screen during computer boot up process.
- ✓ If there is a message **Out of Range** on the screen during computer boot up process, this means computer compatibility caused by operating system or graphic card. The system will adjust the refresh rate automatically. Just wait until the operating system is launched.

## Audio

- ? No sound can be heard from the built-in speakers.
- ✓
  - Check whether the desired cable to input audio signals is properly connected. See [Connect the headphone. on page 27](#) for details.
  - Increase the volume (volume may be muted or too low).
  - Remove your headphone and/or external speakers. (If they are connected to the monitor, the built-in speakers are automatically muted.)
- ? Sound from the built-in speakers is low or unclear.
- ✓
  - Increase the volume (volume may be too low).
  - Make sure the Noise Filter function of the built-in speakers is disabled. This function is not recommended for music or movie playback. To disable the Noise Filter function, press the Noise Filter Speaker key and select **OFF** from the hotkey menu.
- ? No sound can be heard from the connected external speakers.
- ✓
  - Remove your headphone (if the headphone is connected to the monitor).
  - Check whether the headphone jack is properly connected.
  - If the external speakers are USB-powered, check whether the USB connection is OK.
  - Increase the volume (volume may be muted or too low) on the external speakers.
- ? (Selected models only) The built-in microphone does not respond when the monitor is connected to a PC.
- ✓
  - (Models with USB-C™) Check if the certified USB-C™ cable with signal transmission and power delivery functions is properly connected.
  - Increase the MIC volume from the **Audio** menu. See [Audio menu on page 70](#) for more information.

## Sensors (selected models only)

- ? The light sensor of the monitor does not work well.
- ✓ The light sensor is located at the front bottom of the monitor. Please check:
  - If you have removed the sensor protection sticker.
  - If the Brightness Intelligence Gen2 function is set to **ON**. Check **Eye Care > B.I. Gen2**.
  - If there are any obstacles in front of the sensor that keep the sensor from detecting the light properly.
  - If there are any objects or clothing in bright colors in front of the sensor. Bright colors (especially white and fluorescent colors) reflect light and the sensor cannot detect the main light sources.

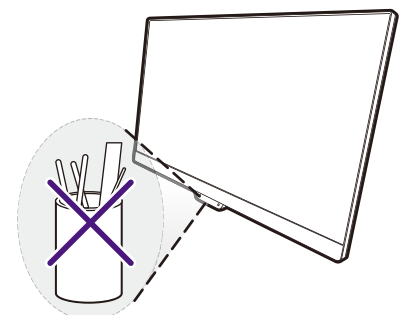

## MST connection (models with USB-C and DisplayPort outputs only)

- ? The MST function does not work.
- ✓
  - Make sure **ON** is selected under **Coding Booster > MST**.
  - Make sure the graphic card on your computer supports DP 1.4 for MST.
  - (Selected models only) If the monitor shows black screen while connecting, go to **Menu > System > USB-C Configuration** and select **USB 2.0**.
  - The compatibility of each computer varies by hardware and/or software. You may need to go through all the cables, specifications and settings to ensure that your system supports MST. If your computer is a Mac, try with a Windows system. MST is available on a Mac OS via Thunderbolt connection only.

## USB-C™ connection (models with USB-C™)

- ? No video or audio output from the laptop with USB-C™ connection.
- ✓
  - Check the cable connections and menu settings in the following order.
  - Check if the USB-C™ cable has been connected to the monitor and the laptop properly. See [Connect the PC video cable on page 27](#) for more information.
  - Check if the input source has been selected to **USB-C** from **Input**.

## Night Hours Protection

- ? **Night Hours Protection** is grayed out in Quick menu.
- ✓ **Night Hours Protection** settings in the Quick Menu will become grayed out if the function is (1) set to **OFF**, or (2) set to **Auto Switch** and is not activated under a bright environment.
  - If the function is set to **OFF**, go to **Menu > Eye Care > Night Hours Protection > Switch** and set the function to **ON**.
  - To adjust the level directly, go to **Menu > Eye Care > Night Hours Protection > Level**. The adjustment will be saved under your current color mode.

## MoonHalo

- ? Why do the **MoonHalo** settings change once I switch the color mode?
- ✓ **MoonHalo** settings will be saved and applied by color mode switch. See [Adjustable OSD settings on page 51](#) for more information.

## DualView Plus

- ? Can I adjust settings such as **Low Blue Light Plus** or **B.I. Gen2** on my second input sources while using **DualView Plus**?
- ✓ When **DualView Plus** is activated, all settings are based on the main input source. Switching the color mode of the main input also adjusts **Night Hours Protection**, **B.I. Gen2**, **Low Blue Light Plus**, **Color Weakness**, and **MoonHalo** settings for the entire screen.

## Need more help?

If your problems remain after checking this manual, please contact your place of purchase or visit the local website from [Support.BenQ.com](https://support.benq.com) for more support and local customer service.